

SLV-SE85/SF90/SF99

RMT-V259D/V259E/V259F/V259G/V259H/V259J/V260/V260A/V260B

SERVICE MANUAL



Photo: SLV-SF90
RMT-V259F

VHS

Hi-Fi

SHOWVIEW[®]
DELUXE

UK Model

SLV-SE85UX/SF90UX(SF)/
SF90UX(WF)/SF99UX

French Model

SLV-SE85B/SF90B(SF)/
SF90B(WF)/SF99B

German Model

SLV-SE85VC/SF90VC(SF)/
SF90VC(WF)/SF99VC

Spanish Model

SLV-SE85NP/SF90NP(SF)/
SF90NP(WF)/SF99NP

E Model

SLV-SF99EN

Irish Model

SLV-SF90EX

SR MECHANISM

Refer to the SERVICE MANUAL of VHS MECHANICAL
ADJUSTMENT VI for MECHANICAL ADJUSTMENTS
(9-921-647-13).

SPECIFICATIONS

System

Channel coverage

PAL (B/G)

VHF E2 to E12

VHF Italian channel A to H

UHF E21 to E69

CATV S01 to S05, S1 to S20

HYPER S21 to S41

RF output signal

UHF channels 21 to 69

Aerial out

75-ohm asymmetrical aerial socket

Inputs and outputs

LINE-1 (TV)

21-pin

Video input: pin 20

Audio input: pins 2 and 6

Video output: pin 19

Audio output: pins 1 and 3

DECODER/ LINE-4 IN

21-pin

Video input: pin 20

Audio input: pins 2 and 6

LINE-2 IN

VIDEO IN, phono jack (1)

Input signal: 1 Vp-p, 75 ohms, unbalanced, sync
negative

AUDIO IN, phono jack (2)

Input level: 327 mVrms

Input impedance : more than 47 kilohms

LINE-3 IN

VIDEO IN, phono jack (1)

Input signal: 1 Vp-p, 75 ohms, unbalanced, sync
negative

AUDIO IN, phono jack (2)

Input level: 327 mVrms

Input impedance : more than 47 kilohms

LINE-2 OUT

VIDEO OUT, phono jack (1)

Output signal: 1 Vp-p, 75 ohms, unbalanced, sync
negative

AUDIO OUT, phono jack (2)

Rated output level: 327 mVrms

Load impedance: 47 kilohms

Output impedance: less than 10 kilohms

General

Power requirements

220 - 240 V AC, 50 Hz

Power consumption

25 W (Normal)

3, 5 W (POWER SAVE is set to ON, no decoder)

Operating temperature

5°C to 40°C

Storage temperature

-20°C to 60°C

Dimensions

Approx. 430 × 100 × 335 mm (w/h/d)

including projecting parts and controls

Mass

Approx. 4.9 kg

Supplied accessories

Remote commander (1)

R6 (size AA) batteries (2)

Aerial cable (1)

Audio cable (1) (SF99)

EURO-AV cable (1)

SmartFile labels (5) (10. for UX)

Satellite controller (1) (SE85/SF90)

Design and specifications are subject to change without
notice.

VIDEO CASSETTE RECORDER



SONY[®]

SAFETY-RELATED COMPONENT WARNING!!

COMPONENTS IDENTIFIED BY MARK \triangle OR DOTTED LINE WITH MARK \triangle ON THE SCHEMATIC DIAGRAMS AND IN THE PARTS LIST ARE CRITICAL TO SAFE OPERATION. REPLACE THESE COMPONENTS WITH SONY PARTS WHOSE PART NUMBERS APPEAR AS SHOWN IN THIS MANUAL OR IN SUPPLEMENTS PUBLISHED BY SONY.

ATTENTION AU COMPOSANT AYANT RAPPORT À LA SÉCURITÉ!

LES COMPOSANTS IDENTIFIÉS PAR UNE MARQUE \triangle SUR LES DIAGRAMMES SCHÉMATIQUES ET LA LISTE DES PIÈCES SONT CRITIQUES POUR LA SÉCURITÉ DE FONCTIONNEMENT. NE REMPLACER CES COMPOSANTS QUE PAR DES PIÈSES SONY DONT LES NUMÉROS SONT DONNÉS DANS CE MANUEL OU DANS LES SUPPLÉMENTS PUBLIÉS PAR SONY.

SAFETY CHECK-OUT

After correcting the original service problem, perform the following safety checks before releasing the set to the customer.

1. Check the area of your repair for unsoldered or poorly-soldered connections. Check the entire board surface for solder splashes and bridges.
2. Check the interboard wiring to ensure that no wires are "pinched" or contact high-wattage resistors.
3. Look for unauthorized replacement parts, particularly transistors, that were installed during a previous repair. Point them out to the customer and recommend their replacement.
4. Look for parts which, through functioning, show obvious signs of deterioration. Point them out to the customer and recommend their replacement.
5. Check the B+ voltage to see it is at the values specified.
6. Flexible Circuit Board Repairing
 - Keep the temperature of the soldering iron around 270°C during repairing.
 - Do not touch the soldering iron on the same conductor of the circuit board (within 3 times).
 - Be careful not to apply force on the conductor when soldering or unsoldering.

TABLE OF CONTENTS

SERVICE MODE

1. ERROR CODE INDICATION	5
--------------------------------	---

1. GENERAL

Getting Started

Step 1 Unpacking	1-1
Step 2 Setting Up the remote commander	1-1
Step 3 Connecting the VCR	1-3
Step 4 Tuning your TV to the VCR	1-4
Step 5 Setting up the VCR with the Auto Set Up function	1-4
Step 6 Setting the clock	1-5
Step 7 Setting the satellite tuner	1-6
Selecting a language	1-8
Presetting channels	1-8
Setting/changing the station names	1-9
Changing/disabling programme positions	1-10
Setting the PAY-TV/Canal Plus decoder	1-11

Basic Operations

Playing a tape	1-12
Recording TV programmes	1-13
Recording TV programmes using the ShowView system	1-14

Additional Operations

Setting the timer manually	1-15
Playing/searching at various speeds	1-16
Setting the recording duration time	1-16
Checking/changing/cancelling timer settings	1-17
Recording stereo and bilingual programmes	1-17
Searching using the index function	1-18
Adjusting the picture	1-18
Changing menu options	1-18
Editing with another VCR or stereo system	1-19
Audio dubbing	1-20

SmartFile function

About the SmartFile function	1-20
Recording using the SmartFile function	1-21
Selecting and playing a programme	1-22
Checking the contents of a tape	1-22
Labelling a recorded programme and tape	1-23
Registering the contents of a recorded tape in the SmartFile label	1-24
Protecting a recorded programme	1-25
Erasing the data of an unwanted programme	1-26

Additional Information

Troubleshooting	1-26
Index to parts and controls	1-28
Menu chart	1-29

2. DISASSEMBLY

2-1. CASE, FRONT PANEL BLOCK ASSEMBLY	2-1
2-2. DM-86, FR-161, JK-171, AT-26 BOARDS	2-1
2-3. REAR PANEL	2-2
2-4. NR-27, RP-235 BOARDS	2-2
2-5. SR MECHANISM DECK	2-3
2-6. POWER BLOCK, MA-359 BOARDS	2-3
2-7. INTERNAL VIEWS	2-4
2-8. CIRCUIT BOARDS LOCATION	2-5

3 BLOCK DIAGRAMS

3-1. OVERALL BLOCK DIAGRAM (1)	3-3
OVERALL BLOCK DIAGRAM (2)	3-5
3-2. VIDEO BLOCK DIAGRAM (1)	3-8
VIDEO BLOCK DIAGRAM (2)	3-9
3-3. SERVO BLOCK DIAGRAM (1)	3-11
SERVO BLOCK DIAGRAM (2)	3-13
3-4. MEMORY BLOCK DIAGRAM	3-15
3-5. AUDIO BLOCK DIAGRAM	3-17
3-6. POWER BLOCK DIAGRAM (1)	3-19
POWER BLOCK DIAGRAM (2)	3-21

4. PRINTED WIRING BOARDS AND SCHEMATIC DIAGRAMS

4-1. FRAME SCHEMATIC DIAGRAM	4-3
4-2. PRINTED WIRING BOARDS AND SCHEMATIC DIAGRAMS	4-5
• MA-359 (Y/C PROCESS)(1/7) SCHEMATIC DIAGRAM	4-5
• MA-359 (ARC, AFC, VPS/PDC)(2/7) SCHEMATIC DIAGRAM	4-7
• MA-359 (SERVO/SYSTEM CONTROL)(3/7) SCHEMATIC DIAGRAM	4-9
• MA-359 (IN/OUT SELECT)(4/7) SCHEMATIC DIAGRAM	4-11
• MA-359 (TUNER)(5/7) SCHEMATIC DIAGRAM	4-13
• MA-359 (AUDIO PROCESS)(6/7) SCHEMATIC DIAGRAM	4-15
• MA-359 (DC/DC CONVERTER)(7/7) SCHEMATIC DIAGRAM	4-17
• MA-359 (Y/C PROCESS, ARC, AFC, VPS/PDC, SERVO/SYSTEM CONTROL, IN/OUT SELECT, TUNER, AUDIO PROCESS, DC/DC CONVERTER) PRINTED WIRING BOARD	4-19
• RP-235 (REC/PB HEAD AMP) PRINTED WIRING BOARD	4-25
• RP-235 (REC/PB HEAD AMP) SCHEMATIC DIAGRAM	4-27
• JK-171 (LINE 2 IN) PRINTED WIRING BOARD AND SCHEMATIC DIAGRAM	4-29
• DM-86 (USER CONTROL) PRINTED WIRING BOARD AND SCHEMATIC DIAGRAM	4-31
• FR-161 (MODE CONTROL, FL DRIVE) PRINTED WIRING BOARD	4-33
• FR-161 (MODE CONTROL, FL DRIVE) SCHEMATIC DIAGRAM	4-35
• SE-90 (SECAM CHROMA PROCESS) PRINTED WIRING BOARD	4-38
• SE-90 (SECAM CHROMA PROCESS) SCHEMATIC DIAGRAM	4-39
• NR-27 (DNR, Y/C SELECT) PRINTED WIRING BOARD	4-41
• NR-27 (DNR, Y/C SELECT) SCHEMATIC DIAGRAM	4-43
• SRV879EK (POWER SUPPLY) PRINTED WIRING BOARD	4-45
• POWER BLOCK (SRV879EK) SCHEMATIC DIAGRAM	4-47
• ML-17 (SMART FILE), AT-25 (INNER SMART FILE SENSOR), AT-26 (FRONT SMART FILE SENSOR) PRINTED WIRING BOARDS	4-49
• ML-17 (SMART FILE)(1/2), AT-25 (INNER SMART FILE SENSOR), AT-26 (FRONT SMART FILE SENSOR) SCHEMATIC DIAGRAM	4-51
• ML-17 (SMART FILE)(2/2) SCHEMATIC DIAGRAM	4-53

5. INTERFACE, IC PIN FUNCTION DESCRIPTION

5-1. SYSTEM CONTROL — VIDEO BLOCK INTERFACE (MA-359 BOARD IC160)	5-1
5-2. SYSTEM CONTROL — SERVO PERIPHERAL CIRCUIT INTERFACE (MA-359 BOARD IC160)	5-1

5-3.	SYSTEM CONTROL — MECHANISM INTERFACE (MA-359 BOARD IC160)	5-2
5-4.	SYSTEM CONTROL — SYSTEM CONTROL PERIPHERAL CIRCUIT INTERFACE (MA-359 BOARD IC160)	5-2
5-5.	SYSTEM CONTROL — AUDIO BLOCK INTERFACE (MA-359 BOARD IC160)	5-2
5-6.	SERVO/SYSTEM CONTROL MICROPROCESSOR PIN FUNCTIONS (MA-359 BOARD IC160)	5-3
5-7.	TUNER/TIMER MODE CONTROL PIN FUNCTION (FR-161 BOARD IC180)	5-4

6. ADJUSTMENTS

6-1.	MECHANICAL ADJUSTMENT	6-1
6-2.	ELECTRICAL ADJUSTMENT	6-1
2-1.	PREPARATION BEFORE ADJUSTMENT	6-1
2-1-1.	Equipment Required	6-1
2-1-2.	Equipment Connection	6-1
2-1-3.	Setup for adjustment	6-1
2-1-4.	Alignment Tape	6-1
2-1-5.	Input/Output Levels and impedance	6-2
2-1-6.	Adjustment Sequence	6-2
2-2.	POWER SUPPLY CHECK	6-2
2-2-1.	Power Supply Voltage Check (MA-359 board)	6-2
2-3.	SYSTEM CONTROL SYSTEM ADJUSTMENT	6-3
2-3-1.	Clock Adjustment (FR-161 board)	6-3
2-4.	SERVO SYSTEM ADJUSTMENT	6-3
2-4-1.	RF Switching Position Adjustment (MA-359 board)	6-3
2-4-2.	Hi-Fi Switching Position Adjustment (MA-359 board)	6-3
2-5.	VIDEO SYSTEM CHECK	6-4
2-5-1.	Playback Level Check (MA-359 board)	6-4
2-5-2.	Sync AGC Check (MA-359 board)	6-4
2-5-3.	Deviation Check (MA-359 board)	6-4
2-5-4.	DNR Y Level Adjustment (NR-15 board) (SLV-SF99 model only. (Except B model))	6-5
2-5-5.	DNR C Level Adjustment (NR-15 board) (SLV-SF99 model only. (Except B model))	6-5
2-6.	AUDIO SYSTEM ADJUSTMENT	6-5
2-6-1.	Hi-Fi Audio System Check	6-5
1.	E-E Output Level Check	6-5
2.	Overall Level Characteristics Check	6-5
2-6-2.	Normal Audio System Adjustment	6-6
1.	ACE Head Adjustment	6-6
2.	Frequency Response Check	6-6

7. REPAIR PARTS LIST

7-1.	EXPLODED VIEWS	7-1
7-1-1.	FRONT PANEL AND UPPER CASE SECTION	7-1
7-1-2.	CHASSIS SECTION	7-3
7-1-3.	MECHANISM DECK SECTION-1	7-4
7-1-4.	MECHANISM DECK SECTION-2	7-5
7-1-5.	MECHANISM DECK SECTION-3	7-6
7-2.	ELECTRICAL PARTS LIST	7-7

SERVICE NOTE

1. ERROR CODE INDICATION

- EMERGENCY CODE and ENCODER DATA and FUNCTION MODE will display to the fluorescent display tube in MECHA emergency mode.

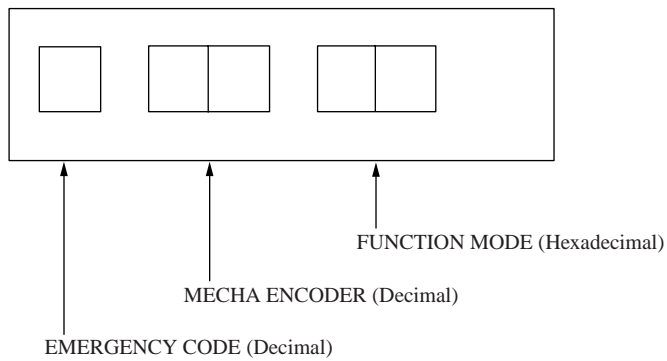

EMERGENCY CODE

Code	Emergency contents
0	No emergency
1	Loading direction cam encoder emergency
2	Unloading direction cam encoder emergency
3	T reel rotation emergency
4	S reel rotation emergency
5	Capstan rotation emergency
6	Drum rotation emergency
7	Cam encoder emergency on initializing
8	Cassette front loading emergency

MECHA ENCODER

Code	Cam position	VTR mode
0	NC	Mode except for the following
1	EJECT	EJECT (Include Power off)
2	CDOWN	Cassette down
3	ULDEND	Tape unload end • Dew stop
4	TLOAD	In tape loading
5	HCLEAN	In tape loading
6	LDEND	Tape loading end
7	RVS	RVS JOG (Include STILL, SLOW)
8	PR	FWD, FWDP/RVS MECHA inhibit
9	FWDP	FWD SLOW, FWD STILL
10	FWDP	PB, FWD JOG • STOP (Drum on)
11	STOP	STOP (Drum off • Power off)
12	FR	FF/REW

FUNCTION MODE

Code (*1)	Code (*2)	Function mode	Code (*1)	Code (*2)	Function mode
00	80	Initial	1E	9E	REW HIGH PB
01	81	Emergency	1F	9F	REC
02	82	Emergency power off	20	A0	REC PAUSE
03	83	EJECT	21	A1	TIMER REC
04	84	EJECT DEW	22	A2	TIMER REC PAUSE
05	85	EJECT power off	23	A3	ORC
06	86	ULDEND	24	A4	VA INSERT
07	87	STOP DEW	25	A5	VA INSERT PAUSE
08	88	ULDEND power off	26	A6	V INSERT
09	89	HCLEAN	27	A7	V INSERT PAUSE
0A	8A	STOP	28	A8	A INSERT
0B	8B	STOP tape end	29	AA	A INSERT PAUSE
0C	8C	STOP tape top	2A	AA	PB
0D	8D	STOP zero	2B	AB	FWD X1
0E	8E	STOP power off	2C	AC	RVS X1
0F	8F	STNBY	2D	AD	FWD X2
10	90	STNBY tape top	2E	AE	RVS X2
11	91	STNBY zero	2F	AF	CUE
12	92	EE FWD	30	B0	REV
13	93	EE RVS	31	B1	CUE LOCK
14	94	FF	32	B2	REV LOCK
15	95	FWD SEARCH	33	B3	EDIT STNBY
16	96	FF 0 PB	34	B4	DUMMY
17	97	FF 0 STOP	35	B5	FWD STILL
18	98	REW	36	B6	RVS STILL
19	99	RVS SEARCH	37	B7	FED STEP
1A	9A	REW 0 PB	38	B8	RVS STEP
1B	9B	REW 0 STOP	39	B9	FWD SLOW
1C	9C	REW PB	3A	BA	RVS SLOW
1D	9D	REW HIGH			

*1 : After MODE INHIBIT.

*2 : MODE INHIBIT.



This section is extracted from instruction manual. (SLV-SF99 model)

Getting Started

Step 1

Unpacking

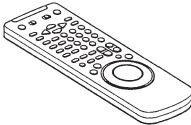
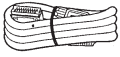
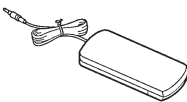
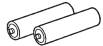
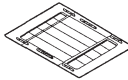
Check that you have received the following items with the VCR:

- Remote commander 
- EURO-AV cable 
- Satellite controller 
- R6 (size AA) batteries 
- SmartFile labels 
- Aerial cable 
- Audio cable 

Checking your model name

The instructions in this manual are for the 2 models: SLV-SF99NP and SF99VC. Check your model number by looking at the rear panel of your VCR. The SLV-SF99VC is the model used for illustration purposes. Any difference in operation is clearly indicated in the text, for example, "SLV-SF99NP only."

4 Unpacking

Getting Started

Step 2

Setting up the remote commander

Inserting the batteries

Insert two R6 (size AA) batteries by matching the + and - on the batteries to the diagram inside the battery compartment.

Insert the negative (-) end first, then push in and down until the positive (+) end clicks into position.

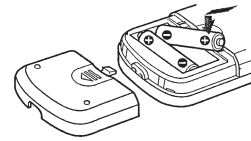

Using the remote commander

You can use this remote commander to operate this VCR and a Sony TV. Buttons on the remote commander marked with a dot (•) can be used to operate your Sony TV. If the TV does not have the  symbol near the remote sensor, this remote commander will not operate the TV.

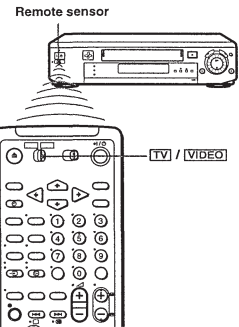

To operate	Set [TV] / [VIDEO] to
the VCR	[VIDEO] and point at the remote sensor on the VCR
a Sony TV	[TV] and point at the remote sensor on the TV

continued

Setting up the remote commander 5

Getting Started

Step 2 : Setting up the remote commander (continued)

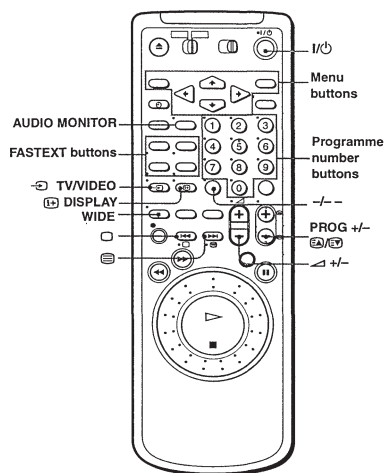

TV control buttons

To	Press
Turn the TV into standby	I/O
Select an input source of the TV either from aerial or from line in	TV/VIDEO
Select the programme position of the TV	Programme number buttons, -/+, PROG +/-
Adjust the volume of the TV	△ +/-

6 Setting up the remote commander

Getting Started

To	Press
Switch to TV (Teletext off)	□ (TV)
Switch to Teletext	⊞ (Teletext)
Select the sound	AUDIO MONITOR
Use FASTEXT	FASTEXT buttons
Call up on-screen display	⊞ DISPLAY
Change the Teletext page	⊞/⊞
Operate TV menu	Menu buttons
Switch to/from wide mode of a Sony wide TV (For other manufacturer's wide TV, see "Controlling other TVs with the remote commander" below.)	WIDE

Notes

- In normal use, the batteries should last about three to six months.
- If you do not use the remote commander for an extended period of time, remove the batteries to avoid possible damage from battery leakage.
- Do not use a new battery with an old one together.
- Do not use different types of batteries together.
- Some buttons may not work with certain Sony TVs.

Setting the COMMAND MODE switch

To remote control the Sony VCR with this remote commander, set COMMAND MODE on the remote commander to the same position as the one on the VCR. Usually, it is set to VTR3. Change the position as shown below to control other Sony VCRs :

- VTR1: For Sony Betamax format VCRs
- VTR2 : For Sony 8mm format VCRs
- VTR3 : For Sony VHS format VCRs

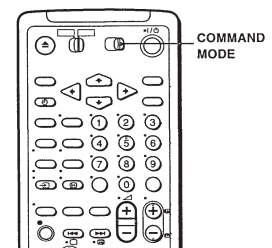

continued

Setting up the remote commander 7

Step 2 : Setting up the remote commander (continued)

Controlling other TVs with the remote commander

The remote commander is preprogrammed to control non-Sony TVs. If your TV is listed in the table below, set the appropriate manufacturer's code number.

- 1** Set TV/VIDEO at the top of the remote commander to TV.
- 2** Hold down I/⏻, and enter your TV's code number(s) using the programme number buttons. Then release I/⏻.
Now you can use the following TV control buttons to control your TV:
I/⏻, TV/VIDEO, programme number buttons, -- (ten's digit), PROG +/-, < +/-, □ (TV), ⊞ (Teletext), FASTEXT buttons, WIDE*, MENU*, CURSOR ↑/↓/←/→*, and OK*.

* These buttons may not work with all TVs.

- Tip**
- When you set your TV's code number correctly while the TV is turned on, the TV turns off automatically.

Code numbers of controllable TVs

If more than one code number is listed, try entering them one at a time until you find the one that works with your TV.

To make wide mode settings, see the footnotes below this table for the applicable code numbers.

Manufacturer	Code number	Manufacturer	Code number
Sony	01 ¹ , 02, 03, 04, 05	NEC	66
Aiwa	32	Nokia	15, 16, 69 ²
Akai	68	Nordmende	35, 42
Blaupunkt	10, 21	Orion	47, 48
Brionvega	40	Panasonic	17 ¹ , 49
C.G.M	09	Philips	06 ¹ , 07 ¹ , 08 ¹
Colonad	03	Phonola	18, 19
Dual	44	Pioneer	26
Emerson	03, 04	Saba	12, 13
Fenner	30, 31	Samsung	22, 23
Ferguson	52	Sanyo	25
Goldstar	03, 04, 17	Schneider	46
Grundig	10 ¹ , 11 ¹	Selec	14
Hitachi	24	Sharp	29
Hyper	31	Siemens	39
Inno-Hit	41	Sinudyne	37
Irradio	20	TEAC	67
ITT	15, 16, 69 ²	Telefunken	36
JVC	33	Thomson	43 ²
Loewe	45	Toshiba	38
Mitsubishi	27 ¹ , 28 ¹ , 50 ¹ , 51 ¹	White Westinghouse	34
Mivar	09		

- ¹ Press WIDE to switch the wide picture modes.
- ² Press WIDE, then press < +/- to select the wide picture mode you want.
- ³ Press WIDE. The menu appears on the TV screen. Then, press CURSOR ↑/↓/←/→ to select the wide picture you want and press OK.

Getting Started

continued

Step 2 : Setting up the remote commander (continued)

- Notes**
- If the TV uses a different remote control system from the one programmed to work with the VCR, you cannot control your TV with the remote commander.
 - If you enter a new code number, the code number previously entered will be erased.
 - If you remove the batteries of the remote commander for more than a few minutes, the code number may be reset to 01 (Sony). In this case, reset the appropriate code number.

**Step 3
Connecting the VCR**

- If your TV has a EURO-AV connector, see below.
 - If your TV does not have a EURO-AV connector, see page 14.
- In any case, if you connect a satellite tuner, see page 15

If your TV has a EURO-AV (Scart) connector

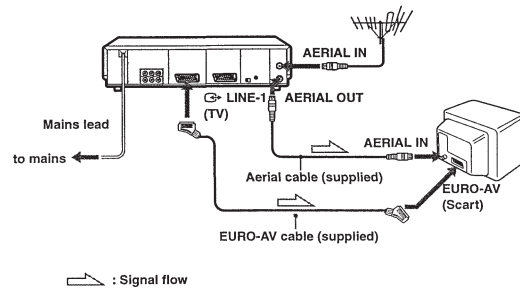

- 1** Disconnect the aerial cable from your TV and connect it to AERIAL IN on the rear panel of the VCR.
- 2** Connect AERIAL OUT of the VCR and the aerial input of your TV using the supplied aerial cable.

Getting Started

continued

Step 3 : Connecting the VCR (continued)

3 Connect LINE-1 (TV) on the VCR and the EURO-AV (Scart) connector on the TV with the supplied EURO-AV cable.

This connection improves picture and sound quality. Whenever you want to watch the VCR picture, press **TV/VIDEO** to display the VIDEO indicator in the display window. If your TV does not have a EURO-AV scart connector, see page 14.

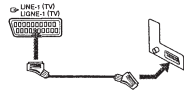

4 Connect the mains lead to the mains.

Note

- If the TV is connected to the LINE-1 (TV) connector, setting the RF MODULATOR in the OTHER OPTIONS menu to OFF is recommended (initial setting). In the OFF position, only the signal from the aerial is output through the AERIAL OUT connector (see page 75). You do not have to tune your TV to the VCR. Skip "Tuning your TV to the VCR" on page 17.

About the SMARTLINK features

If the connected TV complies with SMARTLINK, NexTVView Link, MEGALOGIC¹, EASYLINK², Q-Link³, or EURO VIEW LINK⁴, you can use the SMARTLINK function after you complete the steps on the previous page (the SMARTLINK indicator appears in the VCR's display window when you turn on the TV). You can enjoy the following SMARTLINK features.



- **Preset Download**
You can download your TV tuner preset data to this VCR and tune the VCR according to that data in Auto Set Up. This greatly simplifies the Auto Set Up procedure. Be careful, not to disconnect the cables or exit the Auto Set Up function during the procedure. See "Setting up the VCR with the Auto Set Up function" on page 19.
- **TV Direct Rec**
You can easily record what you are watching on the TV (other than tapes being played on this VCR). For details, see "Recording what you are watching on the TV (TV Direct Rec)" on page 55.
- **One Touch Play**
With One Touch Play, you can start playback automatically without turning on the TV. For details, see "Starting playback automatically with one button (One Touch Play)" on page 51.
- **One Touch Menu**
You can turn on the VCR and TV, set the TV to the video channel, and display the VCR's on-screen display automatically by pressing MENU on the remote commander.
- **One Touch Timer**
You can turn on the VCR and TV, set the TV to the video channel, and display the timer recording menu (the TIMER METHOD menu, the TIMER menu, or the SHOWVIEW menu) automatically by pressing **TIMER** on the remote commander. You can set which timer recording menu is displayed using TIMER OPTIONS in the OTHER OPTIONS menu (see page 77).
- **Automatic Power off**
You can have the VCR turn off automatically, if the VCR is not used for about 1 minute, after you turn off the TV.
- **NexTVView Download**
You can easily set the timer recording by using the NexTVView Download function of your TV. Please, refer to your TV's instruction manual.

¹ "MEGALOGIC" is a registered trademark of Grundig Corporation.
² "EASYLINK" is a trademark of Philips Corporation.
³ "Q-Link" is a trademark of Panasonic Corporation.
⁴ "EURO VIEW LINK" is a trademark of Toshiba Corporation.

Note

- Not all the TVs respond to the functions above.

continued

Step 3 : Connecting the VCR (continued)

If your TV does not have a EURO-AV (Scart) connector

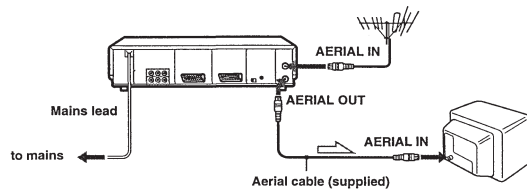

Signal flow

1 Disconnect the aerial cable from your TV and connect it to AERIAL IN on the rear panel of the VCR.

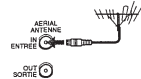

2 Connect AERIAL OUT of the VCR and the aerial input of your TV using the supplied aerial cable.

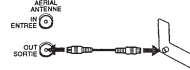

3 Connect the mains lead to the mains.

Note

- When you connect the VCR and your TV only with an aerial cable, you have to set RF MODULATOR in the OTHER OPTIONS menu to ON (see page 75).

Connecting the satellite tuner

If you don't use a satellite tuner, skip to page 17.

If your satellite tuner has a EURO-AV (scart) connector

The illustration below shows an example of connecting the satellite tuner to the LINE-4 IN. In this case, set the SAT. CONNECTION setting to the LINE-4 (see page 27).

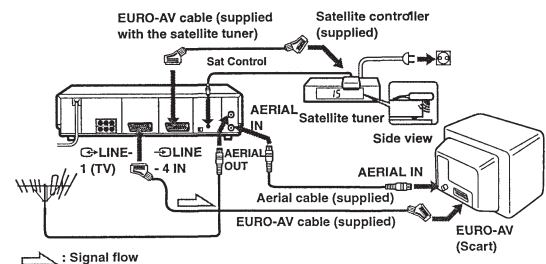

Signal flow

You can watch programmes from the satellite tuner connected to this VCR on the TV even when the VCR is turned off using the Line Through function. When you turn on the satellite tuner, this VCR automatically sends the signal from the satellite tuner to the TV without turning itself on.

- 1** Set DECODER/LINE-4 to LINE-4 in the OTHER OPTIONS menu.
- 2** Set POWER SAVE to OFF in the OTHER OPTIONS menu.
- 3** Turn off the VCR.
To watch a satellite programme, turn on the satellite tuner and the TV.
For details, see page 27.

Note

- You cannot watch satellite programmes on the TV while recording unless you record a satellite programme.

continued

Step 3 : Connecting the VCR (continued)

If your satellite tuner does not have a EURO-AV (Scart) connector
Set the SAT. CONNECTION setting to RF (see page 27).

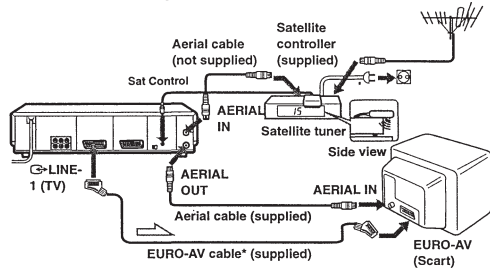

* If your TV doesn't have a EURO-AV (Scart) connector, the EURO-AV cable connected to the VCR is not required.

Additional connections

To a stereo system.

You can improve sound quality by connecting a stereo system to the AUDIO OUT R/L jacks as shown on the right.

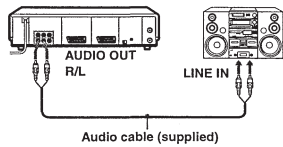

To a TV that has phono type audio/video input jacks (only if you don't connect the VCR and your TV using a EURO-AV connector)

This additional connection improves picture and sound quality. Connect the TV as shown on the right using a commercially available connecting cable like the Sony VMC-810. If your TV has only one audio input jack, use a connecting cable like the Sony VMC-910MS.

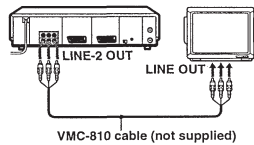

Step 4

Tuning your TV to the VCR

If you have connected the VCR to your TV using the EURO-AV cable, skip this step.

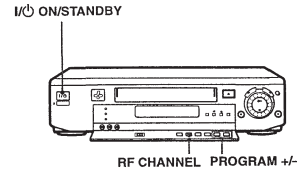

- 1 Press ON/STANDBY to turn on the VCR. Pull down the drop down panel.
- 2 Press briefly RF CHANNEL on the VCR. The factory-preset RF channel appears in the display window. The VCR signal is output through this channel to the TV.
- 3 Turn on your TV and select a programme position for the VCR picture. This programme position will now be referred to as the video channel.

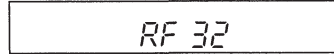

continued

Step 4 : Tuning your TV to the VCR (continued)

- 4 Tune the TV to the same channel as the one shown in the display window so that the picture on the right appears clearly on the TV screen.
Refer to your TV manual for tuning instructions.
If the picture does not appear clearly, see "To obtain a clear picture from the VCR" below.
- 5 Press RF CHANNEL.
You have now tuned your TV to the VCR. From now on, whenever you want to play a tape, set the TV to the video channel.

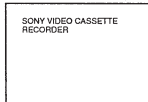

To check if the TV tuning is correct

Set the TV to the video channel and press PROGRAM +/- on the VCR. If the TV screen changes to a different programme each time you press PROGRAM +/-, the TV tuning is correct.

To obtain a clear picture from the VCR

If the screen does not appear clearly in step 4 above, press PROGRAM +/-, so that another RF channel appears. Then tune the TV to the new RF channel until a clear picture appears.

Note

- When you connect the VCR and your TV only with an aerial cable, you have to set RF MODULATOR in the OTHER OPTIONS menu to ON (see page 75).

Step 5

Setting up the VCR with the Auto Set Up function

Before using the VCR for the first time, set up the VCR using the Auto Set Up function. With this function, you can set the language for the on-screen display, TV channels, guide channels for the ShowView system, and VCR clock automatically.

Before you start ...

- Turn on the satellite tuner if it is connected to the VCR only by the aerial cable and not to the EURO-AV cable.

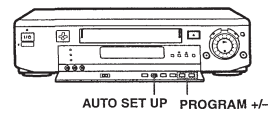

- 1 Hold down AUTO SET UP on the VCR for more than 3 seconds. The VCR automatically turns on, and the country abbreviation appears in the display window.
- 2 Press PROGRAM +/- to highlight the abbreviation of your country. For some countries, there is a selection of languages to choose from. The abbreviations of the countries and languages are as follows :

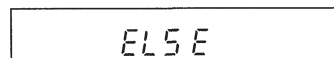

continued

Step 5 : Setting up the VCR with the Auto Set Up function (continued)

Abbreviation	Country	Language	Abbreviation	Country	Language
A	Austria	German	I	Italy	Italian
B-D	Belgium	German	L-D	Luxemburg	German
B-F	Belgium	French	L-F	Luxemburg	French
B-N	Belgium	Dutch	N	Norway	English
CH-D	Switzerland	German	NL	Netherlands	Dutch
CH-F	Switzerland	French	P	Portugal	Portuguese
CH-I	Switzerland	Italian	S	Sweden	English
D	Germany	German	SF	Finland	English
DK	Denmark	English	ELSE	Other countries	English
E	Spain	Spanish			

If your country does not appear in the list, select ELSE.

- 3**  Press AUTO SET UP.
The VCR starts searching for all of the receivable channels and presets them in the appropriate order for your local area.

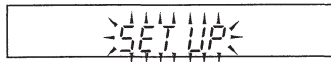

If you use the SMARTLINK connection, the Preset Download function starts and the SMARTLINK indicator flashes in the display window during download.

After the search or download is complete, the current time appears in the display window for any stations that transmit a time signal.

To cancel the Auto Set Up function

Press AUTO SET UP.

Tip

- If you want to change the language for the on-screen display from the one preset in the Auto Set Up function, see page 34.

Notes

- Do not cancel the Auto Set Up function during step 3. If you do, repeat Auto Set Up from the beginning.
- Sometimes, when you operate the Auto Set Up function, some of the settings (ShowView, timer etc...) will be reset. In this case, you have to set them again.

Step 6
Setting the clock



You must set the time and date on the VCR to use the timer recording features properly. The Auto Clock Set function works only if a station in your area is broadcasting a time signal. If the Auto Set Up function did not set the clock correctly for your local area, try another station for the Auto Clock Set function.

Setting the clock manually

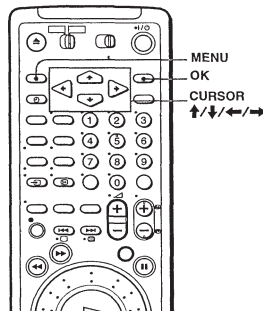

Before you start...

- Turn on the VCR and the TV.
- Set the TV to the video channel.





1  Press MENU, then press CURSOR  to highlight SETTINGS and press OK.



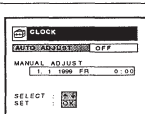

2  Press CURSOR  to highlight CLOCK, then press OK.



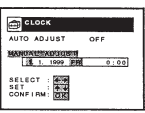

3  Press CURSOR  to highlight MANUAL ADJUST, then press OK.



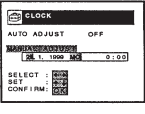

4  Press CURSOR  to set the date.

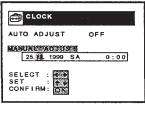

5  Press CURSOR  to highlight the month and set the month pressing CURSOR .



6  Set the year, hour, and minutes in sequence, pressing CURSOR  to highlight the item to be set, and press CURSOR  to select the digits. The day of the week is set automatically.

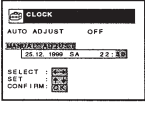

7  Press OK to confirm the setting and start the clock.

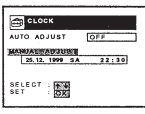

Step 6 : Setting the clock (continued)

8  Press MENU to exit the menu.

Tip

- To change the digits during setting, press CURSOR ← to return to the item to be changed, and select the digits pressing CURSOR ↑/↓.

Note

- The menu disappears automatically if you don't proceed for more than a few minutes.

Changing the station for the Auto Clock Set function

Before you start...

- Turn on the VCR and the TV.
- Set the TV to the video channel.

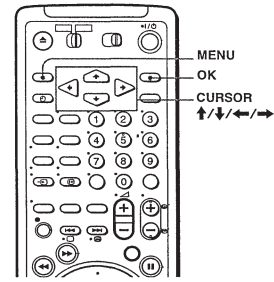

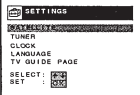

Getting Started

1  Press MENU, then press CURSOR ↑/↓ to highlight SETTINGS and press OK. When using the Auto Set Up procedure, skip this step.

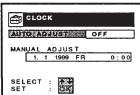

2  Press CURSOR ↑/↓ to highlight CLOCK, then press OK. AUTO ADJUST is highlighted.



3  Press OK.

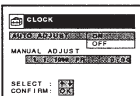

continued

Step 6 : Setting the clock (continued)

4  Press CURSOR ↑/↓ to highlight ON, then press OK.

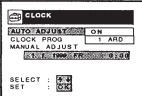

5  Press CURSOR ↓ to highlight CLOCK PROG, then press OK.

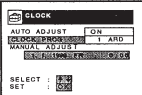

6  Press CURSOR ↑/↓ repeatedly until the programme position of the station that carries the time signal appears. If the VCR does not receive the time signal from any station, AUTO ADJUST returns to OFF automatically.

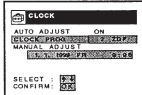

7  Press MENU to exit the menu.

Tips

- To change the digits during setting, press CURSOR ← to return to the item to be changed, and select the digits using CURSOR ↑/↓.
- If you set AUTO ADJUST to ON, the Auto Clock Set function is activated whenever the VCR is turned off. The time is adjusted automatically by making reference to the time signal from the station whose programme position is displayed in the "CLOCK PROG" row. If you do not need the Auto Clock Set, select OFF.

Note

- The menu disappears automatically if you don't proceed for more than a few minutes.

Step 7
Setting the satellite tuner

If you do not connect a satellite tuner, skip this step.

Before you start...

- Turn on the VCR and the TV.
- Set the TV to the video channel.
- Remove the protection sticker of the satellite controller and lean it on the top of the satellite tuner, near the infrared receptor, so that it hangs out over the satellite tuner front (see page 15).

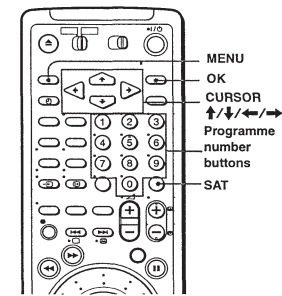

Getting Started

1  Press MENU, then press CURSOR ↑/↓ to highlight SETTINGS and press OK.



2  Press CURSOR ↑/↓ to highlight SATELLITE, then press OK.

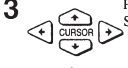

3  Press CURSOR ↑/↓/←/→ to highlight SAT. CONNECTION and press OK.

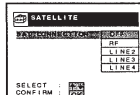

continued

Step 7 : Setting the satellite tuner (continued)

- 4**
- If you connect the satellite tuner using the aerial cable :
Press CURSOR $\uparrow/\downarrow/\leftarrow/\rightarrow$ to select RF and press OK.
Press CURSOR $\uparrow/\downarrow/\leftarrow/\rightarrow$ to highlight PROGRAMME NO. and press OK. Enter the appropriate number using CURSOR \uparrow/\downarrow and press OK.
 - If you connect the satellite tuner using the EURO-AV cable :
Press CURSOR $\uparrow/\downarrow/\leftarrow/\rightarrow$ to select LINE-4 and press OK.

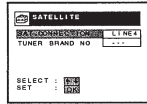
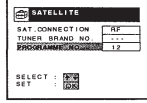

- 5**
- Press CURSOR $\uparrow/\downarrow/\leftarrow/\rightarrow$ to highlight TUNER BRAND NO. and press OK.
Enter the appropriate number using the programme number buttons. Refer to the table on the next page. Press OK.

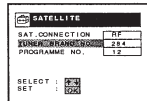

Press MENU to exit the menu.

**Notes**

- If your VCR is connected to the satellite tuner by the aerial cable, enter the programme number of the VCR corresponding to the channel where you have set up the satellite tuner output.
- If you connect the satellite tuner to the LINE input, turn on the VCR and select the appropriate LINE input in step 4 to watch a satellite programme.
- It is recommended to connect your satellite tuner to the LINE-4 connector.
- For some satellite tuner, in order to avoid any conflict between the satellite controller and the VCR remote commander, be careful not to point the remote commander to the satellite tuner and the VCR at the same time.

Satellite tuner brand number

To control the satellite tuner, enter the appropriate number corresponding to your satellite tuner brand.

Some satellite tuners may not operate at all with this VCR.

Satellite tuner brand	Code numbers
ABC	025, 028
ABSat	843
Akai	526
Alba	102, 265, 373, 385, 432, 466, 526, 624
Aldes	299
Allantide	344
Amstrad	091, 224, 263, 349, 356, 472, 512, 520, 686, 700, 822
Andover	555
Ankaro	228, 231, 299, 380, 530
Antron	194, 432
Arcon	283, 379
Armstrong	254
Asat	384
AST	332, 361, 362
Astra	119, 384, 387, 529, 550
Astro	184, 369, 512, 514, 531, 595
Audio Ton	375
Avalon	407
Axis	377, 380, 541
Birmingham Cable Communications	287
British Telecom	116
Barcom	228
Beko	200
Best	228, 380

Satellite tuner brand	Code numbers
Blaupunkt	184
Boca	254, 524, 840
Brain Wave	343
Brunor	420
Bush	078, 102, 265
BT	526, 679, 721
Cabletime	172, 282, 388, 459
Cambridge	267, 355, 526
Camundosat	104
Canal+	864
Canal Satellite	864
Channel Master	373
Chapparral	227
CityCom	405, 829
Clark	822
Clyde	097
CNT	531
Commlink	299
Comtec	277
Connexions	104, 179, 407, 469
Conrad	618
Contec	377
Cryptovision	511
Crown	254

continued

Step 7 : Setting the satellite tuner (continued)

Satellite tuner brand	Code numbers
Cyrus	211
Daewoo	384
D-box	734
DDC	373
Decsat	434
Diskxpress	179, 228
DNT	211, 407, 469
Drake	279, 470
Dynasat	690
Echostar	181, 229, 291, 407, 465, 724, 882
EIF	428, 685
Elita	375, 385
Emanon	432
Emma Esse	708
Engel	461
Eurodec	535, 537
Europa	387, 708
Fenner	728
Ferguson	078, 194, 200, 347, 625, 722
Fidelity	263, 822
Filmnet	454
Finlux	119, 355, 408, 425, 466, 525
Fraba Sat	596
Fracarro	882
France Telecom	462
Freecom	346, 432, 745
FTE	2777, 342, 422, 822
Fuba	183, 228, 238, 308, 309, 380, 407, 425, 428, 432, 452, 720

Satellite tuner brand	Code numbers
Galaxis	299, 375, 667, 824, 844, 845, 874
Galaxisat	332
GEC	097
General Instrument	372
Goldsat	346
Gooding	582
Goodmans	112, 200
Grothusen	346
Grundig	339, 474, 582, 761, 816, 540, 184, 200
G-Sat	194
Harting und Helling	344
High Performance	188
Hinari	194
Hirschmann	184, 298, 344, 408, 409, 506, 512, 513, 584, 592, 683, 732
Hitachi	466, 615
Houston	679
Huth	231, 254, 299, 357, 375, 528, 600, 805
HyperVision	630
Imperial	265, 496
InVidio	882
Intervision	603
IRTE	620
ITS	632
ITT	119, 183
Jerrold	014, 025, 287, 372
Johansson	343
JOK	721
JSR	375

Satellite tuner brand	Code numbers
JVC	526, 582
Kathrein	103, 184, 211, 342, 369, 405, 453, 491, 515, 564, 592, 633, 636, 669
Key West	805
Kosmos	342, 346
Kreiselmeier	184
Kyostar	432
La Sat	435, 475, 524, 531, 618
Lasat	833
Lenco	346, 384, 422, 432, 461
Lennox	603
Lion	364
Lupus	380
Luxor	119, 183, 584, 615
Macab	535, 597
Magnavox	043
Manhattan	466, 531, 603
Maranz	211
Maspro	103, 339, 347, 506, 761
Matsui	355, 582
MediaSat	864
Mediamarkt	254
Memphis	377
Micro Technology	344, 550
Mimtec	237
Minerva	582
Mintec	589
M.N.E.T	454

Satellite tuner brand	Code numbers
MNet	454
Mnet	030
Morgan's	254, 359, 524, 840
Multistar	342, 475
Muratto	346
Navex	343
NEC	189
Neuhaus	512
Neusat	703
Newhaus	231
Next-Wave	743
Nikko	371, 724
Nimbus	237
Nokia	692, 119, 183, 339, 408, 466, 584, 615, 734, 832, 884
Nordmende	393, 625
Oceanic	597
Orbitec	512, 596
Oxford	355
Pace	078, 194, 339, 347, 450, 466, 508, 802, 806
Pal	848
Palcom	238, 308, 309, 452
Palladium	582
Palsat	512
Paltec	238
Panasonic	225
Panda	466
Philips	630, 211, 303, 339, 466, 474, 582, 678, 721, 761, 816, 864

continued

Step 7 : Setting the satellite tuner (continued)

Satellite tuner brand	Code numbers
Phoenix	112, 377
Phonotrend	299, 603, 799
Pioneer	155, 271, 544
Planet	882
Polytron	405
Prima	419
Primestar	372
ProVision	595
Promax	466
Prosat	299, 496
PVP Stereo Visual Matrix	014
Pyxis	842
Quadral	373, 530, 639
Radiola	211
Radix	407, 893
RE	237
Revox	237
RFT	211, 231, 299, 552
Saba	265, 347, 364, 531, 551, 586, 701, 720, 745
Sabre	466
Sagem	831
Sakura	112, 377
Salora	393, 119, 183, 210, 615
Samsung	283, 298, 574
SAT	332, 361, 362, 419, 472
Satbox	386
Satcom	224, 357, 616
Satec	194, 339

Satellite tuner brand	Code numbers
Satmaster	283, 357
SatPartner	343, 346, 432, 513, 531, 720, 745, 822
Satpartner	703
Schneider	816
Schwaiger	194, 405, 515
Scientific Atlanta	019, 028, 288
Seemann	407, 541, 589, 637
SEG	380, 385, 432, 529, 550, 753
Siemens	184
Skymaster	299, 530, 616, 639, 724
Sony	286, 650, 715
Stella	104
Strong	179
STVI	428
STS	167
Sunstar	524, 805
Tandberg	742
Tandy	188
Tantec	308, 309, 347, 466
Tatung	156
TechniSat	272, 273, 331, 420, 469, 512, 552, 559, 596
Techniland	357
Teco	384
Tele+1	454
Telecom	104
Telefunken	432
Teleka	254, 624, 683
Telemax	435

Satellite tuner brand	Code numbers
Telesat	616
Teleservice	292
Televés	596
Tensai	632
Thomson	466, 864
Thorens	597
Tonna	357, 679
TPS	831
Triad	332, 344, 346, 361, 362
Triasat	425, 512
Tristar	277
Tudi	297
Uniden	162, 205, 803, 842
Unisat	377
United Cable	014
Unitor	228, 343
Universum	184, 525, 582
Vector	344, 364, 529
Ventana	211
Videoway	261

Satellite tuner brand	Code numbers
VisiCable+	492
Vortec	432
VTec	473, 771
Vtec	362, 701
Westminster	116
Wevasat	344
Winersat	343
Wisi	184, 332, 362, 383, 407, 417, 418, 426, 466, 551, 647, 649, 701
Wolsey	188
Wolsey Gene	555
XSat	900
Xcom Multimedia	900
Zehnder	332, 342, 437, 531, 829
Zenith	011, 536
Zwergnase	805

Note
 • To check if the brand number is entered correctly or not, press SAT repeatedly to display "SAT" in the display window then any number button. If the satellite tuner responds, you have entered the correct brand number.

Selecting a language

You can change the on-screen display language from the one you selected with the Auto Set Up function.

- Before you start...**
- Turn on the VCR and the TV.
 - Set the TV to the video channel.

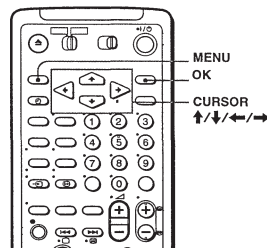

- 1 Press MENU, then press CURSOR \uparrow/\downarrow to highlight SETTINGS and press OK.
- 2 Press CURSOR \uparrow/\downarrow to highlight LANGUAGE, then press OK.
- 3 Press CURSOR $\uparrow/\downarrow/\leftarrow/\rightarrow$ to highlight the desired language then press OK.

Note
 • The menu disappears automatically if you don't proceed for more than a few minutes.

Presetting channels

If some channels could not be preset using the Auto Set Up function, you can preset them manually.



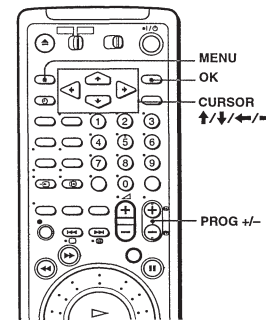

- Before you start...**
- Turn on the VCR and the TV.
 - Set the TV to the video channel.



- 1 Press MENU, then press CURSOR \uparrow/\downarrow to highlight SETTINGS and press OK.
- 2 Press CURSOR \uparrow/\downarrow to highlight TUNER, then press OK.
- 3 Press CURSOR \uparrow/\downarrow to highlight NORMAL/CATV, then press OK.
 Press CURSOR \uparrow/\downarrow to highlight NORMAL, then press OK.
 To preset CATV (Cable Television) channels, select CATV.

continued

Presetting channels (continued)

- 4**  Press CURSOR \uparrow/\downarrow to highlight CHANNEL SET.
- 5**  Press PROG +/- to select the programme position.
- 6**  Press OK to highlight the channel number row, then press CURSOR \uparrow/\downarrow to start tuning.
- The VCR starts searching for a channel and displays the first one it finds on the TV screen. Press CURSOR \uparrow/\downarrow repeatedly until the channel you want is displayed.
- The channels are scanned in the following order:
- VHF E2 - E12
 - VHF Italian channel A - H
 - UHF E21 - E69
 - CATV S1 - S20
 - HYPER S21 - S41
 - CATV S01 - S05
- If you know the number of the channel you want, press the programme number buttons. For example, for channel 05, first press "0" and then press "5."
- 7**  Press OK.
- 8** To allocate another channel to another programme position, repeat steps 4 to 6.

- 9**  Press MENU to exit the menu.

Disabling unwanted programme positions

After tuning the TV channels, you can disable unused programme positions. The disabled positions will be skipped later when you press the PROG +/- buttons. You can also disable unwanted programme positions using the CHANNEL LIST menu (see page 40).

- 1 In step 6 above, press programme number button "0" twice to display the number "00" beside CHANNEL SET.
- 2 Press OK to confirm the setting, then MENU to exit the menu.

If the picture is not clear

Normally, the Auto Fine Tuning (AFT) function automatically tunes in channels clearly. If, however the picture is not clear, you may also use the manual tuning function.

- 1 Press PROG +/- or the programme number buttons to select the programme position for which you cannot obtain a clear picture.
 - 2 Press MENU, then select SETTINGS and press OK.
 - 3 Select TUNER, then press OK.
 - 4 Select FINE TUNING.
- The fine tuning meter appears.

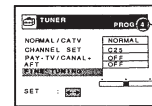

Selected programme position

- 5 Press CURSOR \leftarrow/\rightarrow to get a clearer picture, then press MENU to exit the menu.

Note that the AFT (Auto Fine Tuning) setting switches to OFF.

Note

- The menu disappears automatically if you don't proceed for more than a few minutes.



Setting/changing the station names



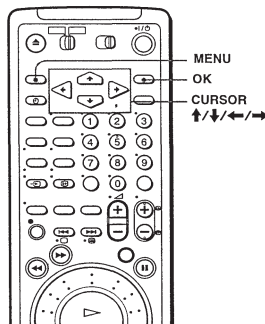

You can also set and change station names as you like. The set station names are displayed on the TV screen when you change the programme position on the VCR. You can change the station names (up to 5 characters).

Before you start...

- Turn on the VCR and the TV.
- Set the TV to the video channel.



- 1**  Press MENU, then press CURSOR \uparrow/\downarrow to highlight LISTS and press OK.
- 2**  Press CURSOR \uparrow/\downarrow to highlight CHANNEL LIST, then press OK.
- 3**  Press CURSOR \uparrow/\downarrow to highlight the row on which you want to set or change the station name.
- To display other pages for programme positions 6 to 60, press CURSOR \uparrow/\downarrow repeatedly.

- 4**  If you want to set the station name, press CURSOR \rightarrow twice to highlight the station name column only.
- If you don't want to set the station name, go to step 7.
- 5**  Enter the station name.
- 1 Press CURSOR \uparrow/\downarrow to select a character.
- Each time you press CURSOR \uparrow , the character changes as shown below.
- A \rightarrow B \rightarrow ... \rightarrow Z \rightarrow a \rightarrow b \rightarrow ...
 \rightarrow z \rightarrow 0 \rightarrow 1 \rightarrow ... \rightarrow 9 \rightarrow
 (symbols) \rightarrow (blank space) \rightarrow A
- 2 Press CURSOR \rightarrow to set the next character.
- The next space is highlighted.
- To correct a character, press CURSOR \leftarrow until the character you want to correct is highlighted, then reset it.
- You can set up to 5 characters for the station name.
- 6** To change or to set the station name of another station, repeat steps 2 to 4.
- 7**  Press OK to confirm the setting.
- 8**  Press MENU to exit the menu.

Note

- The menu disappears automatically if you don't proceed for more than a few minutes.

Changing/disabling programme positions

After setting the channels, you can change the programme positions as you like. If any programme positions are unused or contain unwanted channels, you can disable them.

Before you start...

- Turn on the VCR and the TV.
- Set the TV to the video channel.

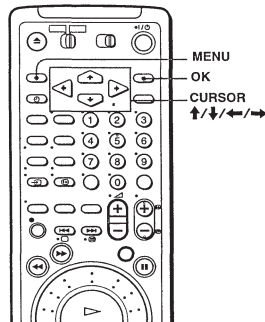

Changing programme positions

- 1** Press MENU, then press CURSOR \uparrow/\downarrow to highlight LISTS and press OK.
- 2** Press CURSOR \uparrow/\downarrow to highlight CHANNEL LIST, then press OK.

- 3** Press CURSOR \uparrow/\downarrow to highlight the row on which you want to change the programme position, then press CURSOR \rightarrow .

To display other pages for programme positions 6 to 60, press CURSOR \uparrow/\downarrow repeatedly.
- 4** Press CURSOR \uparrow/\downarrow until the selected channel row moves to the desired programme position.

The selected channel is inserted at the new programme position and the intermediate channels are displaced to fill the gap.
- 5** Press OK to confirm the setting.
- 6** To change the programme position of another station, repeat steps 3 to 5.
- 7** Press MENU to exit the menu.

Getting Started

continued

Changing/disabling programme positions (continued)

Disabling unwanted programme positions

After presetting channels, you can disable unused programme positions. The disabled positions will be skipped later when you press the PROG +/- buttons.

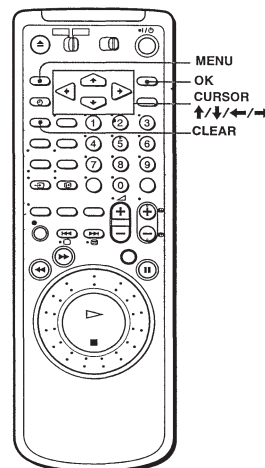

- 1** Press MENU, then press CURSOR \uparrow/\downarrow to highlight LISTS, and press OK.

- 2** Press CURSOR \uparrow/\downarrow to highlight CHANNEL LIST, then press OK.
- 3** Press CURSOR \uparrow/\downarrow to highlight the row on which you want to disable.
- 4** Press CLEAR.

The selected row will be cleared as shown on the right.
- 5** Repeat steps 3 and 4 for any other programme positions you want to disable.
- 6** Press MENU to exit the menu.

Getting Started

Notes

- The menu disappears automatically if you don't proceed for more than a few minutes.
- Be sure to select the programme position you want to disable correctly. If you disable a programme position by mistake, you need to reset that channel manually.

Setting the PAY-TV/Canal Plus decoder

You can watch or record PAY-TV/Canal Plus programmes if you connect a decoder (not supplied) to the VCR.

Connecting a decoder

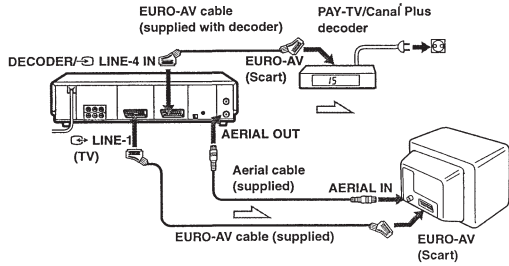

:Signal flow

Setting PAY-TV/Canal Plus channels

To watch or record PAY-TV/Canal Plus programmes, set your VCR to receive the channels using the on-screen display.

Before you start...

- Turn on the VCR, the TV, and the decoder.
- Set the TV to the video channel.

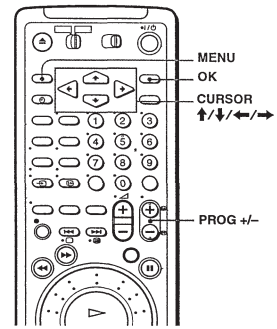

Getting Started

1 Press MENU, then press CURSOR \uparrow/\downarrow to highlight OPTIONS and press OK.

2 Press CURSOR \uparrow/\downarrow to highlight OTHER OPTIONS, then press OK.

3 Press CURSOR \uparrow/\downarrow to highlight DECODER/LINE4, then press OK.

continued

Setting the PAY-TV/Canal Plus decoder (continued)

4 Press CURSOR \uparrow/\downarrow to highlight DEC., then press OK.

5 Press MENU to exit the menu.

6 Press MENU, then press CURSOR \uparrow/\downarrow to highlight SETTINGS and press OK.

7 Press CURSOR \uparrow/\downarrow to highlight TUNER, then press OK.

8 Press CURSOR \uparrow/\downarrow to highlight NORMAL/CATV, then press OK.

9 Press CURSOR \uparrow/\downarrow to highlight NORMAL, then press OK. To preset CATV (Cable Television) channels, select CATV.

10 Press PROG +/- to select the desired programme position.

11 Press CURSOR \uparrow/\downarrow to highlight CHANNEL SET, then press OK.

12 Press CURSOR \uparrow/\downarrow to select the PAY-TV/Canal Plus channels. When the desired channel is tuned, press OK.

13 Press CURSOR \uparrow/\downarrow to highlight PAY-TV/CANAL+, then press OK.

Getting Started

continued

Setting the PAY-TV/Canal Plus decoder (continued)

- 14** Press CURSOR \uparrow/\downarrow to highlight ON, then press OK.

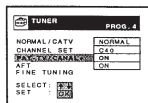
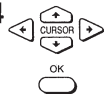

- 15** Press MENU to exit the menu.



Notes

- The menu disappears automatically if you don't proceed for more than a few minutes.
- To superimpose subtitles while watching PAY-TV/Canal Plus programmes, make both decoder-VCR and VCR-TV connections using 21-pin EURO-AV cables that are compatible with the RGB signals. You cannot record subtitles on the VCR.
- When you watch PAY-TV/Canal Plus programmes using the aerial input of the TV, press \square TV/VIDEO so that the VIDEO indicator appears in the display window.
- Some PAY-TV/Canal Plus decoders may not work if you set the PAY-TV/CANAL + setting to ON. In this case, set it to OFF.

Playing a tape

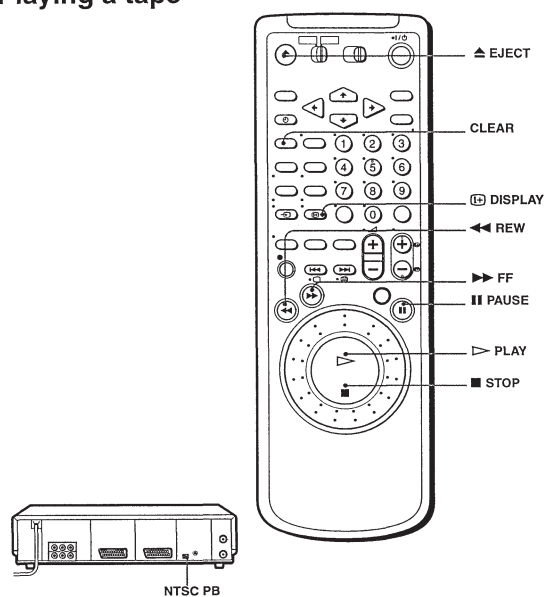

- 1** Turn on your TV and set it to the video channel.

- 2** Insert a tape.
The VCR turns on and starts playing automatically if you insert a tape with its safety tab removed.

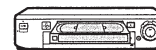

continued

Basic Operations

Playing a tape (continued)

- 3** Press \triangleright PLAY.
When the tape reaches the end, it will rewind automatically.

Additional tasks

To	Press
Stop play	\blacksquare STOP
Pause play	\parallel PAUSE
Resume play after pause	\parallel PAUSE or \triangleright PLAY
Fast-forward the tape	\gg FF during stop
Rewind the tape	\ll REW during stop
Eject the tape	\blacktriangle EJECT

To play an NTSC-recorded tape

Set NTSC PB at the rear of the VCR according to the colour system of your TV.

When your TV is	Set NTSC PB to
PAL only	ON PAL TV
PAL and NTSC	NTSC 4.43

To use the time counter

At the point on the tape that you want to find later, press CLEAR. The counter in the display window resets to "0:00:00." Search for the point afterwards by referring to the counter.

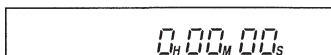

To display the counter on the TV screen, press \square DISPLAY.

Basic Operations

Notes

- The counter resets to "0:00:00" whenever a tape is reinserted.
- The counter stops counting when it comes to a portion with no recording.
- The time counter does not appear on the TV screen when using an NTSC-recorded tape.
- Depending on your TV, the following may occur while playing an NTSC-recorded tape:
 - The picture becomes black and white.
 - The picture shakes.
 - No picture appears on the TV screen.
 - Black streaks appear horizontally on the TV screen.
 - The colour density increases or decreases.
- If you playback a tape in LP or EP mode with NTSC system, the sound is heard in monaural.
- While setting the menu on the TV screen, you cannot use CURSOR $\uparrow/\downarrow/\leftarrow/\rightarrow$ buttons for tape operation.

Starting playback automatically with one button (One Touch Play)

If you use the SMARTLINK connection, you can turn on the VCR and the TV, set the TV to the video channel, and start playback automatically with one button.

- 1** Insert a tape.
The VCR automatically turns on.
If you insert a tape with its safety tab removed, the TV turns on and switches to the video channel. Playback starts automatically.
- 2** Press \triangleright PLAY.
The TV turns on and switches to the video channel automatically. Playback starts.

Tip

- When there already is a tape in the VCR, the VCR and the TV turn on, the TV is set to the video channel, and playback starts automatically in one sequence when you press \triangleright PLAY.

Note

- When you use the One Touch Play function, leave the TV on or in the standby mode.

Recording TV programmes

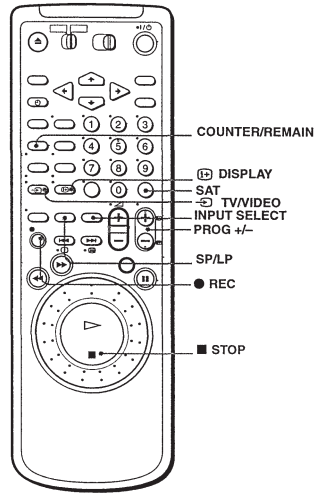

- 1 Turn on your TV and set it to the video channel.
To record from a decoder, turn it on.
- 2 Insert a tape with its safety tab in place.

- 3
 - To record a terrestrial channel.
Press PROG +/- until the programme position number you want appears in the display window.
 - To record a video source from the LINE-1 (TV) or LINE-4 (Scart) connector, or the LINE-2IN or LINE-3 IN jacks. Press INPUT SELECT until L1, L2, L3 or L4 appears in the display window.
 - To select a satellite channel.
Press SAT. The SAT indicator lights up in the display window. Then enter a three digit satellite channel number with the programme number buttons.
 - 4
 - Press SP/LP to select the tape speed, SP or LP.
 - LP (Long Play) provides recording time twice as long as SP, however, SP (Standard Play) produces better picture and audio quality.
 - 5
 - Press ● REC to start recording.
 - The recording indicator lights up red in the display window.
- To stop recording**
Press ■ STOP.

continued

Recording TV programmes (continued)

To check the remaining time

Press □ DISPLAY. With the display on, press COUNTER/REMAIN to check the remaining time. Each time you press COUNTER/REMAIN, the time counter and the remaining time appear alternately. The remaining time with the ◯ indicator also appears in the display window.



In order to get an accurate remaining time indication, be sure the TAPE LENGTH item in TAPE OPTIONS menu is set according to the tape type you use (see page 75).

To watch another TV programme while recording

- 1 Press ⇄ TV/VIDEO on the remote commander to turn off the VIDEO indicator in the display window.
- 2 Select another programme position on the TV.

To protect a recording

To prevent accidental erasure, break off the safety tab as illustrated. To record on a tape again, cover the tab hole with adhesive tape.

You can also protect a recording by using the SmartFile function (see page 102).

Tips

- To select a programme position, you can use the programme number buttons on the remote commander. For two-digit numbers, press the --(ten's digit) button followed by the programme number buttons.
- The display appears on the TV screen indicating information about the tape, but the information won't be recorded on the tape
- If you don't want to watch TV while recording, you can turn off the TV. When using a decoder, make sure to leave it on.

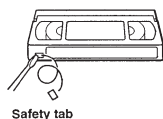

Notes

- The display does not appear during still (pause) mode or slow-motion playback.
- The display will not appear while playing an NTSC-recorded tape.
- If a tape has portions recorded in both PAL and NTSC systems, the time counter reading will not be correct. This discrepancy is due to the difference between the counting cycles of the two video systems.
- You cannot watch a PAY-TV/Canal Plus programme while recording another PAY-TV/Canal Plus programme.
- The remaining time is intended for rough measurement only.
- The remaining time will be displayed only about 30 seconds after the tape is inserted.

Recording what you are watching on the TV (TV Direct Rec)

If you use the SMARTLINK connection, you can easily record what you are watching on the TV (other than tapes being played on the VCR).

- 1 Insert a tape with its safety tab in place.
- 2 Press ● REC while you are watching a TV programme or external source.
The VCR automatically turns on, then the TV indicator lights up and the VCR starts recording what you are watching on the TV.

Tips

- The TV indicator appears in the display window after you press ● REC in some situations such as:
 - when you are watching a source connected to the TV's line input, or
 - when the TV tuner preset data for the programme position is different from the data in the VCR tuner preset.
- If there is a tape with its safety tab in place in the VCR, the VCR automatically turns on and starts recording what you are watching on the TV when you press ● REC.
- You can turn the TV Direct Rec function ON and OFF in the OTHER OPTIONS menu (see page 75).

Notes

- You cannot record what you are watching using this method when the VCR is in the following modes : pause, timer standby, tuner preset, Auto Set Up, and recording.
- When the TV indicator is lit in the display window, do not turn off the TV nor change the TV programme position. When the TV indicator is not lit, the VCR continues recording the programme even if you change the TV programme position on the TV.

Recording TV programmes using the ShowView system

The ShowView system is the feature that simplifies programming the VCR to make timer recording. Just enter the ShowView number listed in the TV programme guide. The date, times, and programme position of that programme are set automatically. You can preset up to eight programmes at a time.

Before you start...

- Check that the VCR clock is set to the correct time and date.
- Insert a tape with its safety tab in place. Make sure the tape is longer than the total recording time.
- Turn on your TV and set it to the video channel.
- If you insert a tape with the SmartFile function, make sure the total recording time doesn't overlap the protected programme. For details about the SmartFile function, see page 82.
- Set TIMER OPTIONS to SHOWVIEW or VARY in the OTHER OPTIONS menu (see page 77).

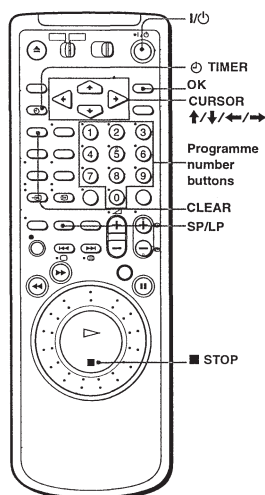

1 Press **TIMER**.
 • When you set TIMER OPTIONS to VARY
 The TIMER METHOD menu appears on the TV screen. Press CURSOR **↑/↓** to select SHOWVIEW, then press OK.

• When you set TIMER OPTIONS to SHOWVIEW
 The SHOWVIEW menu appears on the TV screen.

2 Press the programme number buttons to enter the ShowView number.
 If you make a mistake, press CLEAR and re-enter the correct number.

continued

Recording TV programmes using the ShowView system (continued)

3 Press OK.
 The date, start and stop times, programme position, tape speed, and VPS/PDC setting appear on the TV screen.

If “- -” appears in the “PROG.” (programme) column (this may happen for local broadcasts), you have to set the appropriate programme position manually.

- To select a satellite channel
 Press SAT. “SAT ---” appears in the PROG position on the TV screen. Then enter a three digit channel number with the number buttons.
- To select a terrestrial channel.
 Press CURSOR **↑/↓** to select the desired programme position.
- To select a video source from the LINE-1 (TV) or LINE-4 IN connector, or the LINE-2 IN or the LINE-3 jacks.
 Press INPUT SELECT to select the desired video source. You will only have to do this operation once for the referred channel. The VCR will then store your setting.

When you have selected A (Austria), CH (Switzerland), or D (Germany) with the country selection in the Auto Set Up procedure, the VPS/PDC function is automatically set to ON.
 For details of the VPS/PDC function, see “Timer recording with VPS/PDC signals” on page 59.

If the information is incorrect, press CLEAR to cancel the setting.

4 If you want to change the date, tape speed, and the VPS/PDC function setting:

- 1 Press CURSOR **←/→** to highlight the item you want to change.
- 2 Press CURSOR **↑/↓** to reset it.

- To record the same programme every day or the same day every week, see “Daily/weekly recording” on page 59.
- To use the VPS/PDC function, set VPS/PDC to ON. For details of the VPS/PDC function, see “Timer recording with VPS/PDC signals” on page 59.
- To change the setting, press MENU, and highlight LIST, then select TIMER LIST and press OK. To enter the timer setting and change it, press again OK.

If the informations are not correct, press CLEAR to cancel the settings.

5 Press OK to confirm the setting.

6 Press I/O to turn off the VCR.
 The **⊙** indicator appears in the display window and the VCR stands by for recording.

To stop recording

To stop the VCR while recording, press **■ STOP**.

Daily/weekly recording

In step 4 above, press CURSOR **↓** to select the recording pattern. Each time you press CURSOR **↓**, the indication changes as shown below. Press CURSOR **↑** to change the indication in reverse order.

TODAY → SU-SA (Sunday to Saturday) → MO-SA (Monday to Saturday) → MO-FR (Monday to Friday) → SA (every Saturday) → MO (every Monday) → SU (every Sunday) → 1 month later → (dates count down) → TOMORROW → TODAY

Timer recording with VPS/PDC signals

Some broadcast systems transmit VPS (Video Programme System) or PDC (Programme Delivery Control) signals with their TV programmes. These signals ensure that your timer recordings are made regardless of broadcast delays, early starts, or broadcast interruptions (with the VPS or PDC indicator in the display window lit).

In step 4 above, press CURSOR **↑/↓** to turn on/off the VPS/PDC indication after you set the recording date. If you do not want to set the VPS/PDC function, turn off the VPS/PDC indication.

You can also use the VPS/PDC function for a source connected to the LINE-1 (TV) and LINE-4 IN (Scart) connectors, or the LINE-2 IN or LINE-3 IN jacks.

continued

Recording TV programmes using the ShowView system (continued)

To use the VCR after setting the timer

To use the VCR before a timer recording begins, just press I/O. The ⊕ indicator turns off and the VCR switches on. Remember to press I/O to reset the VCR after using the VCR.

You can also do the following tasks while the VCR is recording:

- Reset the counter.
- Display tape information on the TV screen.
- Check the timer settings see "Setting the timer manually" on page 61.
- Watch another TV programme.

Tips

- To set the programme position with a two digit number, press +/- (ten's digit) button followed by the programme number button.
- To set the programme position, you can also use the PROG +/- or programme number buttons.
- To set the tape speed, you can also use the SP/LP button.
- When you are recording a programme in the SP mode and the remaining tape becomes shorter than the recording time, the tape speed is automatically changed to the LP mode. Note that some interference will appear on the picture at the point the tape speed is changed. If you want to keep the same tape speed, set AUTO LONG PLAY to OFF in the TAPE OPTIONS menu (see page 75).
- To check, change, or cancel the programme setting, press CURSOR ←/→ to choose LIST, then press OK after step 4. For details, see step 3 in "Checking/changing/cancelling timer settings" on page 68.

Notes

- When setting the timer with VPS/PDC signals, enter the start and stop times exactly as indicated in the TV programme guide, otherwise the VPS/PDC function won't work and the recording won't start.
- If the VPS/PDC signal is too weak or the broadcasting station failed to transmit VPS/PDC signals, the VCR will start recording at the set time without using the VPS/PDC function.
- The ⊕ indicator flashes in the display window when you press I/O with no tape inserted.
- The VPS/PDC function is automatically set to OFF for the timer recording of a satellite programme.
- When you set TIMER OPTIONS to STANDARD in the OTHER OPTIONS menu, the SHOWVIEW menu does not appear on the TV screen. Select SHOWVIEW or VARY.

Setting the timer manually

If the ShowView system is not available in your area, follow the instructions below to set the timer to record programmes.

Before you start...

- Check that the VCR clock is set to the correct time and date.
- Insert a tape with its safety tab in place. Make sure the tape is longer than the total recording time.
- To record from a decoder, turn it on.
- Turn on your TV and set it to the video channel.
- If you insert a tape with the SmartFile function, make sure the total recording time doesn't overlap the protected programme. For details about the SmartFile function, see page 82.
- Set TIMER OPTIONS to STANDARD or VARY in the OTHER OPTIONS menu (see page 77).

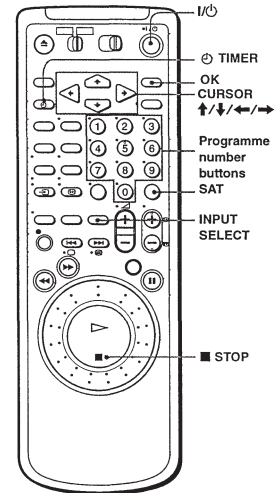

continued

Setting the timer manually (continued)

- 1** Press ⊕ TIMER.
- When you set TIMER OPTIONS to VARY The TIMER METHOD menu appears on the TV screen. Press CURSOR ↑/↓ to select STANDARD, then press OK.
 - When you set TIMER OPTIONS to STANDARD The TIMER menu appears on the TV screen.

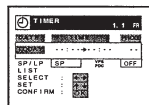
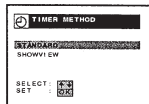

- 2** Set the date, start and stop times, programme position, tape speed, and VPS/PDC function:
- 1 Press CURSOR → to highlight each item in turn.
 - 2 Press CURSOR ↑/↓ to set each item.

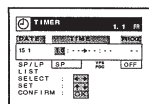

- To correct a setting, press CURSOR ← to return to that setting and reset.
- To record the same programme every day or the same day every week, see "Daily/weekly recording" on page 63.
 - To use the VPS/PDC function, set VPS/PDC to ON. For details of the VPS/PDC function, see "Timer recording with VPS/PDC signals" on page 59.
 - To record from a decoder or other source connected to the LINE-1 (TV) or LINE-4 IN connectors, the LINE-2 IN or the LINE-3 IN jacks, press INPUT SELECT to display "L1," "L2," "L3" or "L4" in the "PROG." position.
 - To record from the satellite tuner, press SAT to display "SAT--" in the PROG position then enter a three digit number with the programme number buttons.

- 3** Press OK to confirm the setting.

- 4** Press I/O to turn off the VCR.
- The ⊕ indicator appears in the display window and the VCR stands by for recording.
- To record from a decoder or other sources, leave the connected equipment switched on.

To stop recording

To stop the VCR while recording, press ■ STOP.

Daily/weekly recording

In step 2 above, press CURSOR ↓ to select the recording pattern. Each time you press CURSOR ↓, the indication changes as shown below. Press CURSOR ↑ to change the indication in reverse order.

TODAY → SU-SA (Sunday to Saturday) → MO-SA (Monday to Saturday) → MO-FR (Monday to Friday) → SA (every Saturday) → MO (every Monday) → SU (every Sunday) → 1 month later → (dates count down) → TOMORROW → TODAY

Tips

- To set the programme position, you can also use the PROG +/- or programme number buttons.
- To set the tape speed, you can also use the SP/LP button.
- When you are recording a programme in the SP mode and the remaining tape becomes shorter than the recording time, the tape speed is automatically changed to the LP mode. Note that some interference will appear on the picture at the point the tape speed is changed. If you want to keep the same tape speed, set AUTO LONG PLAY to OFF in the TAPE OPTIONS menu (see page 75).
- Even if you set TIMER OPTIONS to SHOWVIEW in the OTHER OPTIONS menu, you can set the timer manually. Press MENU to select TIMER, then go to step 2.

Notes

- When setting the timer with VPS/PDC signals, enter the start and stop times exactly as indicated in the TV programme guide, otherwise the VPS/PDC function won't work and the recording won't start.
- If the VPS/PDC signal is too weak or the broadcasting station failed to transmit VPS/PDC signals, the VCR will start recording at the set time without using the VPS/PDC function.
- The VPS/PDC function is automatically set to OFF for the timer recording of a satellite programme.
- The ⊕ indicator flashes in the display window when you press I/O with no tape inserted.

Playing/searching at various speeds

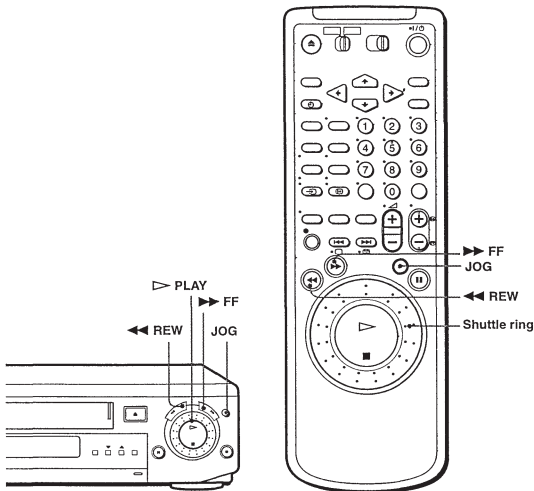

Playback options	Operation
Fast-forward or rewind	During stop, press ►►FF or ◄◄REW.
View the picture during fast-forward or rewind	During fast-forward, hold ►►FF down. During rewind, hold ◄◄REW down.
Rewind and start play	During stop, hold ◄◄REW down on the VCR and press ▷PLAY on the VCR then release both.

Using the shuttle ring

With the shuttle ring, you can operate a variety of playback options. There are two ways for using the shuttle ring, normal mode and jog mode.

To use the shuttle ring in normal mode.

During playback or pause, turn the shuttle ring clockwise or anticlockwise. Each change in the shuttle ring position changes the playback mode, and the corresponding mark appears on the TV screen for a few seconds in the following way if the on-screen display function is on :

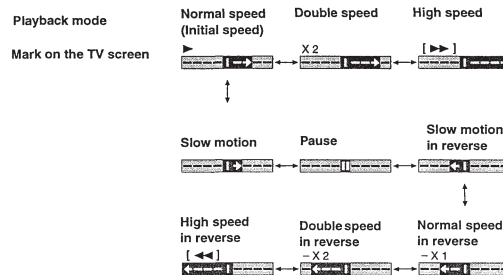

To use the shuttle ring in jog mode

Use this mode for frame-by-frame playback.

Press JOG to enter the jog mode. The JOG button lights up. If you change to the jog mode during any playback mode, the playback pauses so you can see a still picture. Each change in the shuttle ring position shifts the picture one frame. To shift frames in reverse, turn the shuttle ring anticlockwise. The frame shift speed depends on the speed you turn the shuttle ring. To resume normal mode, press JOG again. The JOG button goes off.

continued

Playing/searching at various speeds (continued)

To resume normal playback

Press ▷PLAY.

Tip

- Adjust the picture using the TRACKING +/- buttons if:
 - Streaks appear while playing in slow motion.
 - Bands appear at the top or bottom while pausing.
 - The picture shakes while pausing.
- To set tracking to the centre position, press both buttons (+/-) at the same time.

Notes

- The playback sound is muted during the operations in the above table.
- In the LP mode, noise may appear or there may be no colour.
- If the playback mode mark doesn't appear on the TV screen, press [DISPLAY].

Setting the recording duration time

After starting recording in the normal way, you can have the VCR stop recording automatically after a specified duration.

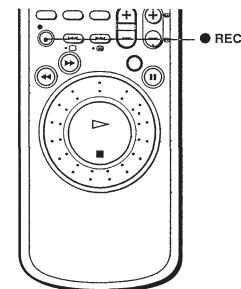

1 While recording, press ●REC.

The Ⓢ indicator appears in the display window.



2 Press ●REC repeatedly to set the duration.

Each press advances the time in increments of 30 minutes.

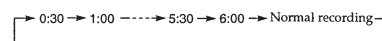

The tape counter decreases minute by minute to 0:00, then the VCR stops recording and turns off automatically.

To extend the duration

Press ●REC repeatedly to set a new duration.

To cancel the duration

Press ●REC repeatedly until the Ⓢ indicator disappears and the VCR returns to normal recording mode.

To stop recording

To stop the VCR while recording, press ■STOP.

Note

- You cannot display the current tape time in the display window when setting the recording duration

Checking/changing/cancelling timer settings

Before you start...

- Turn on your TV and set it to the video channel.

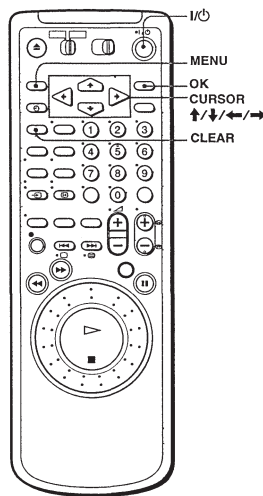

- 1 Press I/O to turn on the VCR.
- 2 Press MENU, then press CURSOR \uparrow/\downarrow to highlight LISTS and press OK.
- 3 Press CURSOR \uparrow/\downarrow to highlight TIMER LIST, then press OK:
 - If you want to change or cancel a setting, go on to the next step.
 - If you do not need to change or cancel the settings, press MENU, then turn off the VCR to return to recording standby.

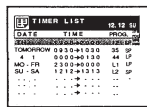

- 4 Press CURSOR \uparrow/\downarrow to select the setting you want to change or cancel, then press OK.
The selected setting appears in the TIMER menu.

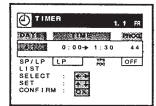

- 5 • To change the setting, press CURSOR \leftarrow/\rightarrow to highlight the item you want to change, and press CURSOR \uparrow/\downarrow to reset it.
• To cancel the setting, press CLEAR.
- 6 Press MENU.
If any settings remain, turn off the VCR to return to recording standby.

When the timer settings overlap

The programme that starts first has priority and the second programme starts recording only after the first programme has finished. If the programmes start at the same time, the programme listed first in the menu has priority.

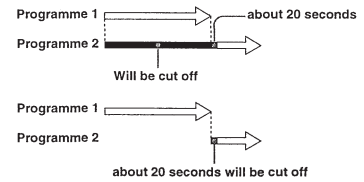

Tip

- In step 6 above, you can check the TIMER LIST by selecting LISTS and pressing OK. Press MENU to exit the TIMER LIST.

Recording stereo and bilingual programmes

In ZWEITON (German stereo) system

This VCR automatically receives and records stereo and bilingual programmes based on the ZWEITON system. When a stereo or bilingual programme is received, the STEREO indicator appears in the display window.

To select bilingual sound while recording

Press AUDIO MONITOR to select the sound you want.

To listen to	On-screen display	Display window
Main	MAIN	STEREO
Sub	SUB	STEREO
Main and sub	MAIN/SUB	STEREO

In NICAM system (SLV-SF99NP only)

This VCR receives and records stereo and bilingual programmes based on the NICAM system (the NICAM indicator appears). When a stereo or bilingual programme is received, the STEREO indicator appears in the display window.

To record a NICAM programme, HI-FI AUDIO in the AUDIO OPTIONS menu should be set to NICAM (initial setting). To check the menu setting, see page 76 for details.

To select the sound while recording

Press AUDIO MONITOR to select the sound you want.

Stereo programme

To listen to	On-screen display	Display window
Stereo	STEREO	STEREO
'Standard sound'	No indicator	No indicator

- Usually the mixed sound of left and right channels (monaural)

Bilingual programme

To listen to	On-screen display	Display window
Main	MAIN	STEREO
Sub	SUB	STEREO
Main and sub	MAIN/SUB	STEREO
'Standard sound'	No indicator	No indicator

- Usually the main sound (monaural)

Selecting the sound during playback

Press AUDIO MONITOR to select the sound you want.

To listen to	On-screen display	Display window
Stereo/main and sub (left and right channels)	STEREO	STEREO
Left channel/main	LCH	STEREO
Right channel/sub	RCH	STEREO
'Standard sound'	No indicator	No indicator

How sound is recorded on a video tape

The VCR records sound onto two separate tracks. Hi-fi audio is recorded onto the main track along with the picture. Monaural sound is recorded onto the normal audio track along the edge of the tape.

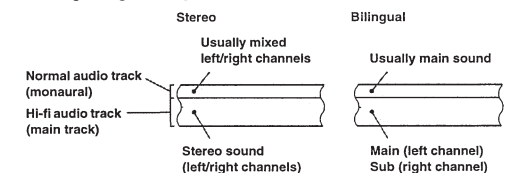

Notes

- To listen to playback sounds in stereo, you must use the EURO-AV or AUDIO OUT connections.
- When you play a tape recorded in monaural, the sound is heard in monaural regardless of the AUDIO MONITOR setting.
- If the AUDIO MONITOR button does not function, check that AUDIO MIX in the AUDIO OPTIONS menu is set to OFF (see page 76).
- If HI-FI AUDIO is set to STANDARD, the standard sound will be recorded on both the hi-fi and normal audio tracks. Pressing AUDIO MONITOR will not change the sound (SLV-SF99NP only).

Searching using the index function

The VCR marks the tape with an index signal at the point where each recording begins. Use these signals as references to find a specific recording. The VCR can search up to 99 index signals ahead or behind the current position.

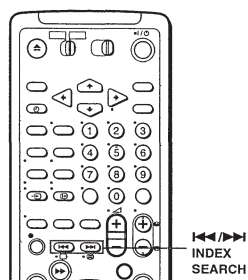

- 1 Insert an indexed tape into the VCR.
- 2 Press **INDEX SEARCH** repeatedly to specify how many index signals ahead or behind you want to search :
 - To search ahead, press **INDEX SEARCH**.
 - To search backwards, press **INDEX SEARCH**.

The VCR starts searching and the index number on the TV screen counts down to zero. Playback starts automatically from that point.

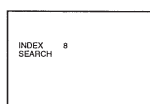

To stop searching
Press **STOP**.

Note

- No index signal will be added when recording starts from recording pause. However, an index signal will be marked if you change the programme position during recording pause.

Adjusting the picture

Adjusting the tracking

Although the VCR automatically adjusts the tracking when playing a tape (the **TRACKING** indicator flashes in the display window, then goes off), distortion may occur if the tape was recorded in poor condition. In this case, manually adjust the tracking.

During playback, press **TRACKING +/-** to display the tracking meter. The distortion should disappear as you press one of the two buttons (the **TRACKING** indicator lights up). To resume automatic tracking adjustments, eject the tape and re-insert it.

To set the tracking to the centre position, press **TRACKING +** and **-** buttons at the same time.

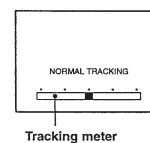

About the Reality Regenerator (RR) function

The Reality Regenerator (RR) function automatically restores the picture to its original quality during playback.

To use the RR function, press **REALITY REGENERATOR**. The **REALITY REGENERATOR** indicator lights up. You can set RR to **HIGH** or **NORMAL** in the **VIDEO OPTIONS** menu (see page 75).

To turn it off, press **REALITY REGENERATOR**. The **REALITY REGENERATOR** indicator lights off.

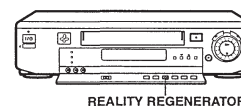

About the Optimum Picture Control (OPC) function

The Optimum Picture Control (OPC) function automatically improves recording and playback quality by adjusting the VCR to the condition of the video heads and tape. To maintain better picture quality, we recommend that you set OPC to **ON** in the **VIDEO OPTIONS** menu (with the OPC indicator in the display window lit). For details, see page 75.



OPC playback

The OPC function automatically works on all types of tapes, including rental tapes and tapes that were not recorded with OPC.

continued

Adjusting the picture (continued)

OPC recording

Whenever you insert a tape and start recording for the first time, the VCR adjusts to the tape using the OPC function (the OPC indicator flashes rapidly). This adjustment is retained until the tape is ejected.

To deactivate the OPC function

Set OPC to **OFF** in the **VIDEO OPTIONS** menu. The OPC indicator in the display window goes off.

About the Digital Noise Reduction (DNR) function

Digital Noise Reduction (DNR) automatically improves playback quality by the digital signal process. To obtain better quality, we recommend you to activate the DNR function by pressing the DNR button on the VCR (the DNR indicator lights up on the VCR).

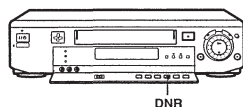

Notes

- You can adjust the tracking for the NTSC-recorded tape but the tracking meter won't be displayed.
- With the Auto Long Play function on, the OPC function will work only in SP mode. If the tape speed automatically switches from SP to LP, the OPC function turns off. However, if the entire programme is recorded in LP mode, the OPC function will work.
- There is a delay of about ten seconds before the VCR actually starts recording while the VCR analyses the tape. To avoid the delay, first set the VCR to recording pause (the OPC indicator flashes slowly) and press **REC** to have the VCR analyse the tape (the OPC indicator flashes rapidly). After the OPC indicator stops flashing, press **PAUSE** to start recording immediately. If you want to start recording quickly without using the OPC function, first set the VCR to recording pause (the OPC indicator flashes slowly) and press **PAUSE** to start recording.

Changing menu options

- 1 Press **MENU**, then select **OPTIONS** and press **OK**.

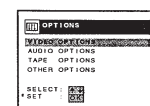

- 2 Press **CURSOR UP/DOWN** to highlight the kind of option to change, **VIDEO OPTIONS**, **AUDIO OPTIONS**, **TAPE OPTIONS** or **OTHER OPTIONS** then press **OK**.

- 3 Press **CURSOR UP/DOWN** to select the option, then press **OK** to enter the pop up menu.

- 4 Press **CURSOR UP/DOWN** to select the desired setting, then press **OK**.

- 5 Press **MENU** to exit the menu.

VIDEO OPTIONS menu

Initial settings are indicated in bold print.

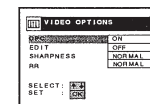

Menu option	Set this option to
OPC	<ul style="list-style-type: none"> • ON to switch on the OPC (Optimum Picture Control) function and improve picture quality. • OFF to switch off OPC.
EDIT	<ul style="list-style-type: none"> • ON to minimize picture deterioration when editing. • OFF to turn off EDIT.
SHARPNESS	<ul style="list-style-type: none"> • LOW to playback a poor quality tape. • NORMAL to playback an average quality tape. • HIGH to playback a good quality tape.
RR	<ul style="list-style-type: none"> • NORMAL for normal everyday use. • HIGH for well-used video tapes such as rented tapes. Select this option when NORMAL does not improve the picture quality. For details, see page 73.

Note

- When you playback with the **EDIT** function **ON**, the **OPC** and the **SHARPNESS** functions don't work.

continued

Changing menu options (continued)

AUDIO OPTIONS menu

Initial settings are indicated in bold print.

SLV-SF99NP

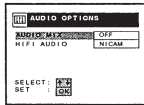

Menu option	Set this option to
AUDIO MIX	<ul style="list-style-type: none"> ON to listen to the hi-fi and normal audio tracks at the same time. The AUDIO MONITOR button will not function. OFF to listen to the hi-fi and normal audio tracks separately. Select the sound using the AUDIO MONITOR button. For details, see page 70.
HIFI AUDIO (only for SLV-SF99NP)	<ul style="list-style-type: none"> STD to record standard sound on the hi-fi audio track. NICAM to record NICAM broadcasts on the hi-fi audio track. For details, see page 70.

TAPE OPTIONS menu

Initial settings are indicated in bold print.

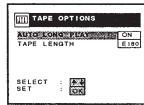

Menu option	Set this option to
AUTO LONG PLAY	<ul style="list-style-type: none"> ON to automatically record from SP (Standard Play) to LP (Long Play) when the tape length is not long enough. OFF to normally record in SP (Standard Play).
TAPE LENGTH	<ul style="list-style-type: none"> E180 to use an E-180 or shorter tape type. E195 to use an E-195. E240 to use an E-240. E300 to use an E-300.

OTHER OPTIONS menu

Initial settings are indicated in bold print.

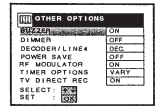

Menu option	Set this option to
BUZZER	<ul style="list-style-type: none"> ON to output a beep sound. OFF to deactivate it.
DIMMER	<ul style="list-style-type: none"> ON to make the display window dim. OFF to make it brighter.
DECODER/LINE4	<ul style="list-style-type: none"> DEC. to use the DECODER/LINE-4 IN connector as the PAY-TV/Canal Plus decoder connector. LINE4 to use the DECODER/LINE-4 IN connector as the line input connector.
POWER SAVE	<ul style="list-style-type: none"> ON to turn off the indicators in the display window to save the VCR power. OFF to turn on the indicators in the display window while the VCR is standing by.
RF MODULATOR	<ul style="list-style-type: none"> ON if you connect the VCR to your TV using only the aerial cable. OFF if you connect the VCR to your TV using the EURO-AV cable.
TIMER OPTIONS	<ul style="list-style-type: none"> VARY (variable) to display the TIMER METHOD menu for selecting STANDARD or SHOWVIEW when pressing the TIMER button. STANDARD to display the TIMER menu when pressing the TIMER button. SHOWVIEW to display the SHOWVIEW menu when pressing the TIMER button. <p>For details, see page 36 and 61.</p>
TV DIRECT REC	<ul style="list-style-type: none"> ON to activate the TV Direct Rec function. OFF to deactivate it.

Note

- When you set a timer recording, the indicators in the display window remain on, even though POWER SAVE is set to ON.

Editing with another VCR or stereo system

How to connect to record on this VCR

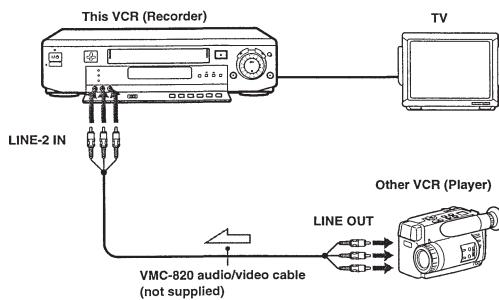

⚡ : Signal flow

Tip

- You can also use the LINE-4 IN connector or the LINE-3 IN jacks instead.

Notes

- Make sure you connect the plugs to jacks of the same colour.
- If the other VCR is a monaural type, leave the red plugs unconnected.
- If you connect this VCR to both the LINE IN and LINE OUT jacks of the other VCR, select the input correctly to prevent a humming noise.

How to connect to a stereo system

Connect the LINE-2 IN AUDIO L/R jacks on this VCR to the audio output jacks on the stereo system, using the RK-C510KS audio cable (not supplied).

Operation (when recording on this VCR)

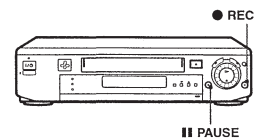

Before you start editing

- Turn on your TV and set it to the video channel. Press INPUT SELECT to display "L2" (or "L3" or "L4") in the display window.
- Press SP/LP to select the tape speed, SP or LP.
- On this VCR, set EDIT to ON in the VIDEO OPTIONS menu to display "EDIT" in the display window. If the other VCR has a similar feature, activate this one as well.

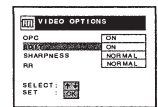

- Insert a source tape with its safety tab removed into the other (playback) VCR. Search for the point to start playback and set it to playback pause.
- Insert a tape with its safety tab in place into this (recording) VCR. Search for the point to start recording and press PAUSE.
- Press REC on this VCR to set it to recording pause.
- To start editing, press the PAUSE buttons on both VCRs at the same time.

To stop editing

Press the STOP buttons on both VCRs.

Tip

- To cut out unwanted scenes while editing, press PAUSE on this VCR when an unwanted scene begins. When it ends, press PAUSE again to resume recording.

Note

- If you start editing following the procedure above, the VCR won't start recording with the OPC function. To record a tape with the OPC function, press REC again during recording pause in step 3 so the VCR analyses the tape. Then, when you start editing in step 4, press PAUSE after the OPC indicator stops flashing. If you press PAUSE before the OPC indicator stops flashing, the OPC function is cancelled.

Audio dubbing

This feature lets you record over the normal audio track. The monaural sound previously recorded is replaced while the original hi-fi sound remains unchanged. Use this feature to add commentary to a tape that you have recorded with a camcorder.

Before you start...

- Turn on the TV and set it to the video channel

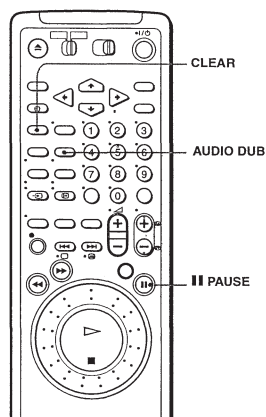

- 1 Insert a source tape into the stereo system (or the playback VCR). Search for the point to start playback and set it to playback pause.
- 2 Insert a prerecorded tape with its safety tab in place into this (recording) VCR. Search for the end of the section to be replaced and press **|| PAUSE**.
- 3 Press **CLEAR** to reset the counter to "0H00M00S."
- 4 Rewind the prerecorded tape to the beginning of the section to be replaced. The VCR enters pause mode.
- 5 Press **AUDIO DUB**. The indicator appears in the display window.
- 6 To start editing, press the **|| PAUSE** buttons on this VCR and the stereo system (or other VCR) at the same time. When the counter reaches "0H00M00S," audio dubbing stops automatically.

To stop while editing

Press **■ STOP** on this VCR and the stereo system (or other VCR).

Note

- After you use this feature, the audio in playback mode is automatically set to monaural.

To listen to both the hi-fi and normal audio

Set **AUDIO MIX** to **ON** in the **AUDIO OPTIONS** menu (see page 76). Use this feature to listen to dubbed audio over the original hi-fi audio. When **AUDIO MIX** is set to **ON**, the **AUDIO MONITOR** button does not function. Note that by mixing both hi-fi and normal audio, some echo may appear.

About the SmartFile function

SmartFile* allows you to view a contents of your video tape (recording date, channel, name etc.) on the TV screen. It is no longer necessary to rewind, fast-forward, or playback a tape to find out what is recorded. You can also locate and start playback of a specific programme or find the position from which you want to start recording by using this list. Programme data is stored in the memory of the SmartFile label attached to the tape.

The following functions are possible using SmartFile :

Recording using the SmartFile function (page 84)

To use the SmartFile function, attach the SmartFile label to the tape. If you record a programme on the tape with a SmartFile label, the contents will appear on the SmartFile search list. With the SmartFile list, you can also easily find the beginning of the available recording space.

SmartFile search list

4H10.6.98-5.2.99	P. 1
BLANK TIME	1h30w
9.2.78 0:00 PROG. 18	0h30w
25.1.10 16:30 PROG. 30	2h00w
11.1.10 17:00	0h30w
START	END
SEARCH	END

Selecting and playing a programme (page 89)

To playback a recorded programme, select the programme you want to watch using the SmartFile search list. The VCR locates the programme and playback starts automatically.

Checking the contents of a tape (page 90)

When you bring the SmartFile label close to the SMARTFILE sensor on the VCR, a summary of the recorded programmes appears in the SmartFile check list. It is not necessary to insert the tape into the VCR and press **▶ PLAY** to find out what is recorded on it. This feature allows you to easily find the programme you want to watch, or to quickly find a tape with enough recording space.

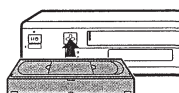

SmartFile check list

4H10.6.98-5.2.99	P. 1
BLANK TIME	1h30w
9.2.78 0:00 PROG. 18	0h30w
25.1.10 16:30 PROG. 30	2h00w
11.1.10 17:00	0h30w
25.1.10 BEST OF THIS YEAR	
10.12.99 21:00 TPT	
1.1.10 5:00 TV	
NEXT	END
EXIT	END

* SmartFile is a trademark of Sony Corporation

Labelling a recorded programme and tape (page 92)

You can attach an electronic "label" to the video tape and its programmes on the SmartFile list. Labelling the recorded programmes enables you to find a programme easily when you want to play it back. If TV guide pages are available in the Teletext, labelling recorded programmes is done automatically. Also, once you label a programme which you set to record regularly (i.e everyday, same day of the week, etc.), the VCR recognizes the label and will automatically label all future recordings of the same programme.

Registering the contents of a recorded tape in the SmartFile label (page 100)

You can register programmes recorded on a tape in the memory of a new SmartFile label.

Protecting a recorded programme (page 102)

You can protect a recorded programme from accidental over-recording or erasure.

Erasing the data of an unwanted programme (page 104)

By erasing a programme from the SmartFile list, the VCR will record over the unwanted programme.

Recording using the SmartFile function

To use the SmartFile function, attach the SmartFile label to the spine of the cassette. If you record a programme on a tape with a SmartFile label, for more than 20 minutes in LP mode and 11 minutes in SP mode, programme data, such as the name, date and channel, is automatically stored in the memory of the SmartFile label. Some stations may not offer this service.

Attaching the SmartFile label to the cassette

To use the SmartFile function, attach the supplied SmartFile label to the cassette. Remove any stains or dirt from the surface of the spine of the tape. Then, holding both edges of the SmartFile label so that it doesn't bend, attach it along the guide line to the spine of the cassette. This tape is henceforth referred to as a SmartFile tape.

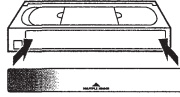

Note on the purchase of SmartFile labels

- If you want to order additional SmartFile labels, contact your nearest Sony service facility.

Notes

- The SmartFile label is equipped with a memory chip. The memory chip may be damaged and cannot be used when you:
 - twist or fold the SmartFile label.
 - remove the SmartFile label and re-attach it to a tape.
 - attach more than one SmartFile label to a tape.
 - attach some metal, or sticker which has metal, to the SmartFile label.
 - write too strongly on the SmartFile label using a ballpoint pen or similar sharp instrument.
 - disassemble or remodel a label.
- Do not leave the SmartFile label in a place subject to excessive dust or dirt, direct sunlight, humidity, mildew, strong magnetism or near heat sources.
- If you attach the SmartFile label to a shorter tape than an E-30, the SmartFile function may not work correctly.

Recording a programme on the SmartFile tape

When recording a programme on the SmartFile tape, no matter what method you use to record the programme (normal recording, showview recording, etc.), programme data (date, name, channel, recording start time, etc.) is stored in the memory of the SmartFile label. The SmartFile label can contain up to 12 programmes' data. When the number of the stored programmes goes over 12, the oldest programme data is erased from the SmartFile list. However, a programme which lasts less than about 20 minutes in LP mode or about 11 minutes in SP mode cannot be stored in the memory. When you record a programme on the SmartFile tape which already contains programme data, see "Recording after locating the Blank Time space" on page 87.

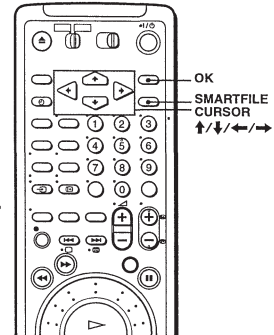

Before you start...

- Turn on your TV and set it to the video channel.
- Check that the VCR clock is set to the correct time and date.

1 Insert a SmartFile tape with its safety tab in place.

2 Press SMARTFILE. The SmartFile search list appears on the TV screen.

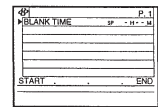

3 Use CURSOR ↑/↓ to select BLANKTIME, press OK. The VCR starts searching for the longest blank part of the tape. The SmartFile searchlist disappears.

You can now start recording a programme.

Tip

- You can protect a recorded programme from accidental over-recording or erasure (see page 102).

Note

- If you press the PAUSE button one or more times during recording, thereby creating short lengths of recorded time between such pauses, programme data may not be stored in the SmartFile label.

continued

Recording using the SmartFile function (continued)

Checking the information of a recorded programme

Press SMARTFILE. The SmartFile search list appears. The recording day of the week, start time, programme position, date, name, recording time and tape speed appear on the list. The longest space which doesn't have any programme data (Blank Time space) appears as "BLANK TIME":

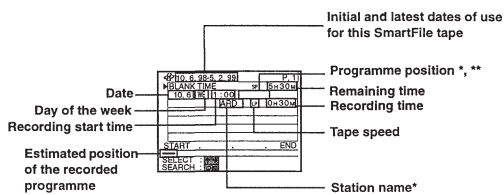

* When the station name is not available, the programme position is displayed instead.

** If you record a satellite programme using non-timer recording "SAT---" appears in the programme position without displaying any channel number in the "---" position.

Tip

- You can manually name a recorded programme and select the category. You can also name the SmartFile tape

Notes

- If you don't set the clock or the clock isn't set to the correct time and date, the recording start time won't be stored correctly on the Smartfile list. Also the programme label won't be stored correctly if the TV guide page information of the Teletext is not set correctly (see page 84).
- When you set the AUTO LONG PLAY option to ON in the TAPE OPTIONS menu, and the tape speed automatically changes from SP to LP during recording, the VCR displays the entire recording time converted in SP mode to the SmartFile list.
- The recording time length in the SmartFile list is an estimation and may be slightly different from the actual recorded time length.

Recording after locating the Blank Time space

The SmartFile function identifies not only the largest amount of available blank space, but also recorded material that doesn't have corresponding programme data stored in the SmartFile label. The longest available recording space (including programmes that are not stored on the SmartFile label) is referred to as "Blank Time space". You can locate the beginning of the Blank Time space for recording. If there is a recorded programme after the Blank Time space, the VCR will over-record on that programme unless you stop recording. If there is a programme you want to prevent from being recorded over or erased, protect that programme before you start recording another programme (see page 102).

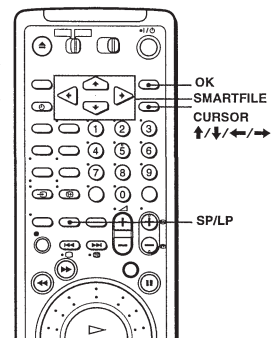

Before you start...

- Turn on your TV and set it to the video channel.

1 Insert a SmartFile tape with its safety tab in place. The SMARTFILE indicator lights up on the VCR.

2 Press SMARTFILE. The SmartFile search list appears on the TV screen. The Blank Time space appears in the "BLANK TIME" row. The Blank Time space also appears in the display window.

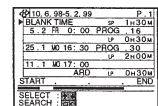

3 Press CURSOR ↑ repeatedly to select BLANK TIME.

4 Press SP/LP to select the tape speed, SP or LP. The BLANK TIME changes according to the selected tape speed. Select a tape speed that matches the length of the programme you want to record.

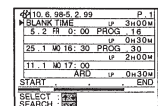

continued

Recording using the SmartFile function (continued)

- Press OK.
The VCR goes to the beginning of the Blank Time space and stops.

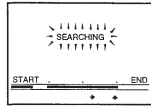

- Press PROG +/- to select the programme position you want to record.
- Press ● REC to start recording.

Notes

- You may not be able to locate the beginning of the Blank Time space correctly in the above step 4 when :
 - the SmartFile tape contains one or more short length (less than about 20 minutes in the LP mode and about 11 minutes in the SP mode) recorded programmes of which programme data are not stored in the SmartFile label.
 - the SmartFile tape is damaged or dirty.
 - the SmartFile tape has a portion recorded in the NTSC system.
- If a newly recorded programme overlaps a stored programme, the stored programme information is erased from the SmartFile list as shown below when :
 - the remaining length of the stored programme becomes less than about 20 minutes in the LP mode and about 11 minutes in the SP mode.
 - the stored programme is over-recorded for more than 20 minutes in the LP mode and about 11 minutes in the SP mode.

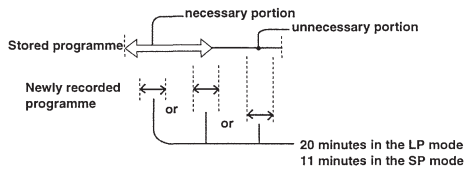

Selecting and playing a programme

You can automatically locate and start playback of a programme recorded on the SmartFile tape. Select a programme in the SmartFile search list. The SmartFile search list can contain up to 12 programmes.

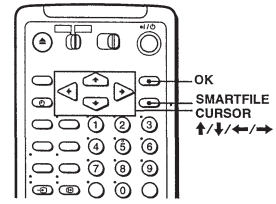

Before you start...

- Turn on your TV and set it to the video channel.

- Insert a SmartFile tape.
The SMARTFILE indicator lights up on the VCR.
- Press SMARTFILE.
The SmartFile search list appears on the TV screen.

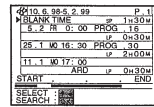

- Press CURSOR ↑/↓ to select a programme.
Press CURSOR ↑/↓ repeatedly to turn the pages.

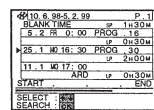

- Press OK.
The VCR starts searching for the beginning of the selected programme. Playback starts automatically from that point.

To stop searching

Press ■ STOP.

Note

- You may not be able to locate the beginning of the selected programme correctly when :
 - the SmartFile tape contains one or more short length (less than about 20 minutes in the LP mode and about 11 minutes in SP mode) recorded programmes of which programme data are not stored in the SmartFile label.
 - the SmartFile tape is damaged or dirty.
 - the SmartFile tape has a portion recorded in the NTSC system.

Checking the contents of a tape

You can display the programme data list of a SmartFile tape on the TV screen. It is not necessary to insert the tape into the VCR. This feature allows you to quickly find a specific programme or to find a tape with enough recording space. The SmartFile check list can contain up to 12 programmes.

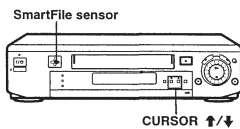

Before you start...

- Turn on your TV and set it to the video channel.
- Turn on your VCR.

- Hold the label side of the SmartFile tape close to the SmartFile sensor.
Slowly bring the center of the label within 3 cm of the SmartFile sensor.
There is a short beep, the SMARTFILE indicator lights up on the VCR, and the SmartFile check list appears. The BLANK TIME space also appears in the display window.

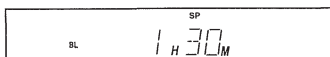
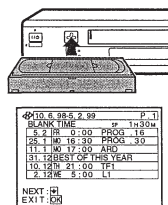

- Press CURSOR ↑/↓ to turn the pages.

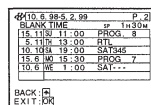

- Press OK to exit the SmartFile check list.

Tip

- If you press a button other than SP/LP or CURSOR ↑/↓, the SmartFile check list disappears.

Notes

- You cannot display the SmartFile check list while :
 - you display the SmartFile list of a different SmartFile tape inserted into the VCR.
 - you display any other menu.
- If the SmartFile check list doesn't appear on the TV screen, try again by drawing the SmartFile tape away from the SmartFile sensor at least 5 cm, then bring it back to within 3 cm of the sensor.
- The menu disappears automatically if you don't proceed for more than a few minutes.

Labelling a recorded programme and tape

Some Broadcast systems ensure a Teletext service in which the complete programmes and their data (title, date, channel, recording start time etc.) are stored day by day. To each day of the week corresponds a TV guide page number. When recording a programme, the VCR automatically takes the label information from the Teletext pages and stores into the SmartFile label. Those TV guide page numbers depend entirely on the broadcast itself and may be subject to change. If so, you may have to set those TV guide page numbers manually in the TV GUIDE PAGE menu.

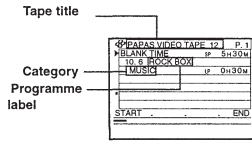

Setting the TV guide page number

Before you start...

Turn on your TV and set it to the video channel.

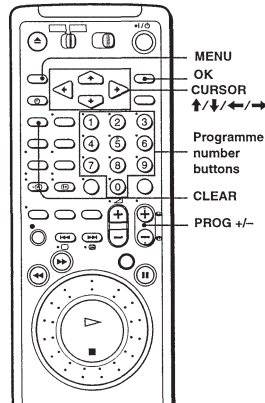

- 1 Select the programme position for which you want to set or change the TV guide page.
- 2 Press MENU, then press CURSOR \uparrow/\downarrow to highlight SETTINGS and press OK.

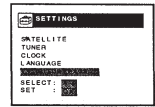

- 3 Press CURSOR \uparrow/\downarrow to highlight TV GUIDE PAGE and press OK.

The TV guide page numbers appear automatically when the VCR detects them.

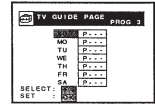

- 4 Press CURSOR \uparrow/\downarrow to select the TV guide page number you want to modify and press OK.

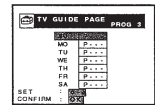

- 5 Press the programme number buttons to enter the TV guide page number and press OK to confirm the setting.

If you make a mistake, press CLEAR to re-enter the correct number.

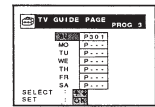

- 6 To set or change another TV guide page number, repeat steps 3 and 4 above.

- 7 Press MENU to exit the menu.

continued

Labelling a recorded programme and tape (continued)

Notes

- In step 4 above, enter "000" if you don't want to use the TV guide page number for automatic labelling. The VCR will then store default data (date, programme position, duration etc.) in the label.
- Refer to the Teletext information on your TV screen to get the TV guide page number with the programme titles and their start times.
- If the Teletext TV guide has a page which always shows the programmes for the current day, this page should be input for all days.
- If you start recording more than two minutes before the programme is scheduled to start, the correct label information may not be transferred. The VCR receives the label information two minutes after the recording starts. This is to assure that the programmes' information is correctly recorded even if you start recording before the programme actually begins.
- If you set a timer recording with VPS/PDC OFF, the title information will be transferred in the middle of the recording.
- Note that this function may not work correctly with programmes broadcast from some stations.
- When the recording starts and if at that moment the Broadcast system updates the Teletext information, the title on the label may not correspond to the one of the recorded programme. In this case, you may have to manually enter the correct title using the SMARTFILE EDIT menu.
- You cannot get the label information from the sources through the LINE input or the satellite channels.

Labelling a recorded programme manually

If Teletext data is not available, label and select the appropriate category of the recorded programme manually. Labelling manually takes priority over labelling automatically. You can also label the tape. Up to 18 characters can be input for a programme and tape label.

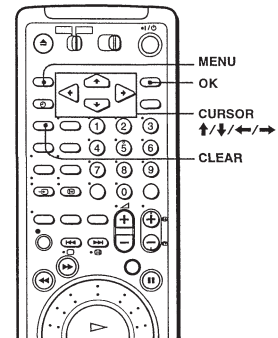

Before you start...

- Turn on your TV and set it to the video channel.

- 1 Insert a SmartFile tape. The SMARTFILE indicator lights up on the VCR.
- 2 Press MENU and select SMARTFILE EDIT, then press OK. The SMARTFILE EDIT menu appears.

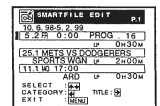

- 3 Press CURSOR \uparrow/\downarrow to select a programme.

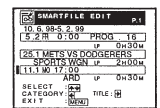

continued

Labelling a recorded programme and tape (continued)

4 Press CURSOR →.

The cursor moves to the programme label input position.

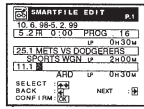

5 Label the programme.

1 Press CURSOR ↑/↓ to select a character. Each time you press CURSOR ↑, the character changes as shown below. A → B → ... → Z → special characters → ! → & → , (comma) → - (hyphen) → . (period) → 0 → 1 ... → 9 → (blank space). You can also select a blank space by pressing CLEAR.

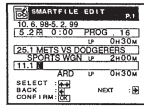

2 To set the next character, press CURSOR →. The cursor moves to the next position.

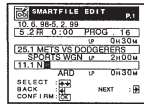

3 Repeat steps 1 and 2 to label the programme.

6 Press OK.

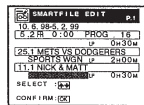

7 Press CURSOR ↑/↓ to select a category.

Each time you press CURSOR ↑, the category changes as shown below.

SPECIAL → FILMS → NEWS → SHOW SPORTS → CHILDRN (children) → MUSIC → ARTS → SERIES → EDU. (education) → LEISURE → SHOPPIN (shopping) → VARIETY → (blank)

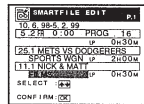

8 Press OK.

The programme label and a selected category are stored.

9 Press MENU to exit the menu.

To erase the programme label

Press CLEAR after step 3 above. The programme label is erased and the default recording data reappear.

To erase the selected category

Press CLEAR in step 7 above. The selected category is erased and the space becomes blank.

To label a regularly scheduled timer-recorded programme

Once you label a programme which is set to record regularly (i.e. everyday, same day of the week, etc.) in the ShowView system or timer recording mode, the VCR recognizes the label and will automatically label all future recordings of the same programme. The set label is assigned even when an information signal containing the programme name, category name or other information is broadcast with the programme. However, if you change the programme label and the category several times, the VCR may automatically label only the last programme of which the programme label and category are changed.

continued

Labelling a recorded programme and tape (continued)

Labelling a tape

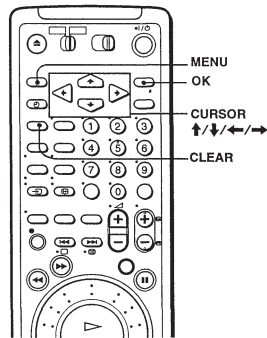

Before you start...

- Turn on your TV and set it to the video channel.

1 Insert a SmartFile tape.

The SMARTFILE indicator lights up on the VCR.

2 Press MENU and select SMARTFILE EDIT, then press OK.

The SMARTFILE EDIT menu appears.

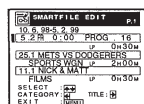

3 Press CURSOR ↑ to select the tape title.

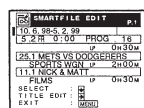

4 Press CURSOR →.

The cursor moves to the title input position.

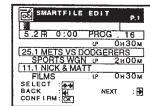

5 Label the tape.

1 Press CURSOR ↑/↓ to select a character. Each time you press CURSOR ↑, the character changes as shown below. A → B → ... → Z → special characters → ! → & → , (comma) → - (hyphen) → . (period) → 0 → 1 ... → 9 → (blank space)

You can also select a blank space by pressing CLEAR.

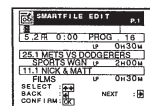

2 To set the next character, press CURSOR →. The cursor moves to the next position.

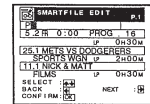

3 Repeat steps 1 and 2 to label the tape.

6 Press OK.

The tape title is stored.

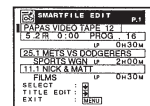

7 Press MENU to exit the menu.

To erase the tape title

Press CLEAR after step 3 above. The tape title is erased and the recording date reappears. When you want to erase the recording date from the tape title column, press CLEAR again.

Registering the contents of a recorded tape in the SmartFile label

The VCR will register programmes recorded on a tape (even a non-SmartFile recorded tape) in the memory of a new SmartFile label by detecting the index signals indicating the start of recorded programmes. You can register up to the 12th programme from the start of the tape. The programmes appear from the bottom of the screen as PROGRAM NO. 1, PROGRAM NO.2, ... PROGRAM NO.12 in the order. The 13th and subsequent programmes are ignored. You can manually name the registered programme numbers and select the category (see page 92).

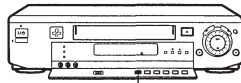

SMARTFILE GENERATOR

Before you start...

- Turn on your TV and set it to the video channel.
- Turn on your VCR.

- 1 Attach the SmartFile label to the spine of the cassette as shown on the right and insert the tape.

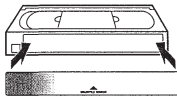

- 2 Press the SMARTFILE GENERATOR button on the VCR.

A message appears indicating that the recorded programmes are being registered. The index signals are detected from the start of the tape, and the registration stops if the end of the tape is reached. The message disappears when registration is complete.

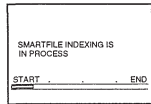

To stop registration to the SmartFile label

Press SMARTFILE GENERATOR.

The data registered before the button is pressed remains in the SmartFile label. You can register the programmes again by pressing SMARTFILE GENERATOR.

To check the information of a registered programme

Press SMARTFILE.

The SmartFile search list appears. The registered programme number, registration date and recording time appear in this list. Note that the registration date differs from the recorded date.

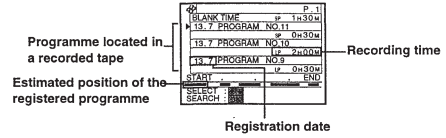

Tips

- The programmes recorded on the tape can be registered again in a SmartFile label that already contains programme data. However, the recorded date and time, programme name and information input manually (such as the programme label and category) are replaced with "PROGRAM NO. XX".
- If the SmartFile label contains stored programme data that includes protected programmes, a message appears and the registration stops.

Notes

- Programme data is not registered correctly in the SmartFile label when :
 - the programme length is about 20 minutes or less in LP mode or about 11 minutes in SP mode.
 - the programme does not have an index signal or the index signal has been recorded over and erased.
 - the tape is damaged or dirty.
- If you don't set the clock or the clock isn't set to the correct date, the registration date won't be stored correctly on the SmartFile list.
- After you press SMARTFILE GENERATOR and start registration, registration is interrupted if you press ■ STOP, [>] PLAY, [FF] REW, [U] or [F] INDEX SEARCH. In these cases as well, the data registered up to the point when registration was interrupted remains in the SmartFile label.
- When you set AUTO LONG PLAY to ON in the TAPE OPTIONS menu, and the tape speed automatically changes from SP to LP during recording, the VCR displays the entire recording time converted in SP mode to the SmartFile list.
- The estimated position of the registered programmes may not be correct in case of many short programmes recorded on long tapes.

Protecting a recorded programme

You can protect a recorded programme using the SmartFile function from accidental over-recording or erasure. When you start recording from a position prior to the protected programme, the recording stops automatically before the protected programme.

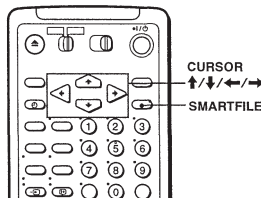

Before you start...

- Turn on your TV and set it to the video channel.

- 1 Insert a SmartFile tape. The SMARTFILE indicator lights up on the VCR.



- 2 Press SMARTFILE. The SmartFile search list appears on the TV screen.

- 3 Press CURSOR ↑/↓ to select the programme you want to protect.

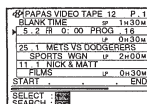

- 4 Press CURSOR →. The indicator appears to the left of the selected programme and the programme is now protected.

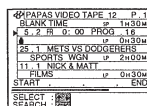

- 5 Press SMARTFILE. The SmartFile search list disappears.

To unlock the protected programme

Press CURSOR ← in the step 4 above. The indicator disappears and you can record over this programme.

Tips

- When you start recording from a position prior to the protected programme, the recording automatically stops no more than about four minutes in SP mode and about eight minutes in LP mode before the beginning of the protected programme. The BLANK TIME indicator flashes in the display window.
- If you protect a programme just after the Blank Time space, BLANK TIME becomes shortened by about four minutes in SP mode and about eight minutes in LP mode.
- If you try to record on a SmartFile tape containing a protected programme, a message indicating that there is a protected programme on this tape appears on the TV screen.

Notes

- When you record another programme just after a protected programme, locate the beginning of the "Blank Time space" by following the instructions in "Recording after locating the Blank Time space" on page 87. Otherwise, if the recording start point overlaps the protected programme, the VCR may over-record the protected programme.
- If you insert a SmartFile tape which contains a protected programme or protect a programme for the first time on a new tape, the VCR will analyse the position of the protected programme for a few seconds. You cannot operate the VCR while the VCR is analysing the tape.
- If the SmartFile list contains 12 protected programmes, the next programme you record won't be stored in the SmartFile list.
- When you try to turn off the VCR after setting a ShowView timer recording on the protected programme, the VCR automatically ejects the cassette.
- The protecting function may not work with an NTSC-recorded tape.

Erasing the data of an unwanted programme

You can erase an unwanted programme from the SmartFile list. When you erase a programme from the list, that portion of tape is subject to Blank Time space priority.

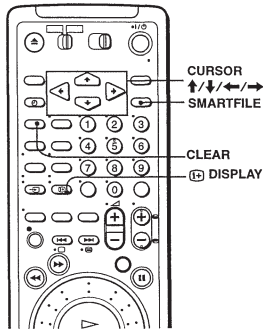

Before you start...

- Turn on your TV and set it to the video channel.

1 Insert a SmartFile tape.
The SMARTFILE indicator lights up on the VCR.

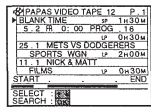

2 Press SMARTFILE.
The SmartFile search list appears on the TV screen.

3 Press CURSOR \uparrow/\downarrow to select a programme you want to erase from the list.

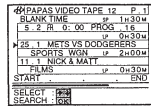

4 Press CLEAR.

The selected programme is erased from the SmartFile list.

If you erase a programme by mistake, press \square DISPLAY to make the programme reappear.

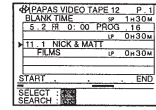

5 Press SMARTFILE.

The SmartFile search list disappears.

Notes

- You cannot erase a protected programme from the SmartFile list. You have to first unlock the protected programme by following the instructions in "To unlock the protected programme" on page 103, then erase that programme from the list.
- The erased programme disappears from the SmartFile list, but it still remains on the tape.
- If a programme is left about 11 minutes or less in SP mode or about 20 minutes or less in LP mode, you cannot make the programme reappear by using the \square DISPLAY button.

Additional Information

Troubleshooting

If you have any questions or if your problems are not covered below, please consult your nearest Sony service facility.

Problem summary

The following table summarizes the reference numbers for the problems you might face. In order to solve your problem, please refer to the corresponding reference (S1=symptom1, S2=symptom2 ...) in the right column below.

Category		Refer to
Picture	• while watching broadcast tuned by the TV.	S2, S6
	• while watching broadcast tuned by the VCR.	S1, S6
	• while playing a tape.	S3, S4, S5
Sound	• while playing a tape.	S7, S8, S9
Functional	• Playback	S4, S9, S10
	• Normal recording	S11, S12
	• SmartFile	S13, S14
	• Timer recording	S15, S16
	• Canal Plus	S17, S18, S19
	• Line selection	S20
	• Remote commander	S21, S22
	• Cleaning	S23
	• Clock	S24
	• Power	S25, S26, S27, S28, S29
	• Tape	S30, S31
• SMARTLINK	S32	
• Satellite tuner control	S33, S34	

Additional Information

Picture			
S1	The VCR picture does not appear on the TV screen.	→	Make sure the TV is set to the video channel. If you are using a monitor, set it to video input.
		→	If the VCR is connected to the TV with the EURO-AV cable, make sure the TV/VIDEO indicator is lit in the display window. Use the TV/VIDEO key on the remote commander to lit the TV/VIDEO indicator.
		→	If the VCR is connected to the TV only with the aerial cable, make sure that RF MODULATOR is set to ON in the OTHER OPTIONS menu (see page 77).
S2	The TV programme is not clear or has some interference.	→	If your TV is connected to the VCR with both EURO-AV and aerial cables, make sure the RF MODULATOR is set to OFF in the OTHER OPTIONS menu (see page 77).
		→	Existing broadcasts may interfere with the VCR. Reset the RF MODULATOR output of your VCR.
S3	The playback picture is not clear or has some interference.	→	If your TV is connected to the VCR with both EURO-AV and aerial cables, make sure the RF MODULATOR is set to OFF in the OTHER OPTIONS menu (see page 77).
		→	Existing broadcasts may interfere with the VCR. Reset the RF MODULATOR output of your VCR.
		→	Adjust the tracking with the TRACKING +/- buttons (see page 73).
		→	The video heads are dirty (see below). Clean the video heads using the Sony T-25CLD, E-25CLDR, or T-25CLW video head cleaning cassette. If these cleaning cassettes are not available in your area, have the heads cleaned at your nearest Sony service facility (a standard service charge will be required). Do not use a commercially available liquid type cleaning cassette other than Sony's, as it may damage the video heads. The video heads may have to be replaced. Consult your local Sony service facility for more information.

Symptoms caused by contaminated video heads

• Normal picture	• Rough picture	Unclear picture	• No picture (or black & white screen appears)
	initial contamination		terminal

continued

Additional Information

Troubleshooting (continued)

Picture	
S4	The tracking meter does not appear on the TV screen. → The recording condition of the tape is very poor and tracking can not be adjusted. → The display does not appear when the tape you are playing is recorded in NTSC.
S5	The picture rolls vertically during picture search. → Adjust the vertical hold control on the TV or monitor.
S6	TV reception is poor. → Make sure the aerial cables are connected securely. → Adjust the TV aerial.
Sound	
S7	The picture has no sound. → The tape is defective. Please use a new tape.
S8	The sound is unstable or has an echo. → When you play a tape with the same sound recorded on both the hi-fi and normal sound tracks, make sure AUDIO MIX in the AUDIO OPTIONS menu is set to OFF (see page 76).
S9	You cannot select the left or the right channel while playing a tape. → Make sure AUDIO MIX is set to OFF in the AUDIO OPTIONS menu (see page 76). → Make sure you are playing a hi-fi tape.
Playback	
S10	The tape starts playing as soon as it is inserted. → This is normal. When you insert a tape which safety tab has been removed, the VCR starts playing automatically.
Normal recording	
S11	The tape is ejected when you press ● REC. → The safety tab has been removed. To record on this tape, cover the tab hole (see page 54).
S12	Nothing happens when you press ● REC. → Make sure the tape is not at its end. → If the BL indicator is flashing in the display window, the tape contains a programme protected by the SmartFile function (see page 102).
SmartFile	
S13	The programme label cannot be taken properly. → Make sure the clock and the date are set correctly. → Check the setting of the TV guide pages. Some stations may not offer this service (see page 92). → If you start recording more than two minutes before the beginning of the programme, the title on the label may not correspond to the one of the recorded programme. Enter manually the correct title using the SMARTFILE EDIT menu (see page 95). → If the TV reception is poor, the VCR will not be able to take the title correctly. Enter manually the correct title using the SMARTFILE EDIT menu (see page 95).

Additional Information

SmartFile	
S14	Recording stops halfway. → If the tape contains a programme protected by the SmartFile function, recording automatically stops before the protected programme. Use another tape which has enough recording space.
Timer recording	
S15	The timer does not operate properly. → Check that the clock is set. → The clock stops if the VCR is disconnected from the mains for more than an hour. Reset the clock and the timer. → Check that the safety tab has not been removed. → If the timer recording overlaps a programme protected by the SmartFile function, the recording stops halfway (see page 102). → The recording start point overlaps the protected programme. → Make sure the tape is not at its end. → Make sure a tape has been inserted. → Make sure the current time has not already passed your timer settings. → If you are recording a programme from a satellite tuner, make sure the satellite tuner is turned on.
S16	The VPS/PDC function does not operate properly. → Check that the clock and the date are set correctly. → Check that the VPS/PDC time you set is the correct one (there might be a mistake in the TV guide programme). If the Broadcast you wanted to record did not send the good VPS/PDC information, the VCR will not start recording. → If the reception is poor, the VPS/PDC signal might be altered and the VCR might not start recording.
Canal Plus	
S17	You cannot set channels as PAY-TV/CANAL+ in the TUNER menu. → Be sure that DECODER/LINE4 is set to DEC. in OTHER OPTIONS menu (see page 77).
S18	You cannot watch Canal Plus when the VCR is in standby mode. → Be sure that DECODER/LINE4 is set to DEC. in OTHER OPTIONS menu (see page 77). → Make sure the Canal Plus EURO-AV cable is plugged securely.
S19	PAY-TV/Canal Plus is always recorded scrambled. → Make sure the Canal Plus EURO-AV cable is set securely. → Be sure that DECODER/LINE4 is set to DEC. in OTHER OPTIONS menu (see page 77). → Be sure that this channel is set as PAY-TV/CANAL+ in TUNER menu (see page 44).
Line selection	
S20	You cannot select LINE4. → Be sure that DECODER/LINE4 is set to LINE4 in OTHER OPTIONS menu (see page 77).

continued

Additional Information

Troubleshooting (continued)

Remote commander	
S21	The remote commander does not operate. → Make sure you are pointing the remote commander at the remote sensor on the VCR. → Replace all the batteries in the remote commander by new ones if they are weak. → Make sure the TV/VIDEO remote control switch is set correctly. → Make sure the COMMAND MODE switch position of the VCR matches to the remote commander's one.
S22	You cannot control your TV. → Set your TV's code number. The code number may change when you replace the batteries of the remote commander (see page 9).
Cleaning	
S23	The VCR needs to be cleaned. → Clean the cabinet, panel and controls with a dry, soft cloth, or a soft cloth slightly moistened with a mild detergent solution. Do not use any type of solvent, such as alcohol or benzene.
Clock	
S24	The clock has stopped and "12:--" lights in the display window. → The clock stops if the VCR is disconnected from the mains for more than one hour. Reset the clock and timer if needed (see page 22).
Power	
S25	The I/ON/STANDBY switch does not function. → Connect the mains lead to the mains securely
S26	The power is turned on but the VCR does not operate. → Moisture condensation occurs. Turn the power off, unplug the mains lead and leave the VCR to dry for over three hours.
S27	The tape is ejected when you press I/ON/STANDBY. → You have set a timer recording, but the tape on which you want to record is protected (or contains protected recordings). Unlock the protection or use another tape or replace the safety tab (see page 103).
S28	The display does not lit when the VCR is in STANDBY mode. → The VCR is in power save mode. Set the POWER SAVE option to OFF in the OTHER OPTIONS menu (see page 77).
S29	POWER SAVE is set to ON but the display remains lit in STANDBY mode. → The display is always lit if the VCR is in timer standby mode. For more details regarding the energy saving, see page 77.

Additional Information

Tape	
S30	The tape is ejected when you press I/ON/STANDBY. → You have set a timer recording, but the tape on which you want to record is protected (or contains protected recordings). Unlock the protection or use another tape or replace the safety tab (see page 103).
S31	A tape cannot be inserted. → Check that a tape isn't already in the tape compartment.
SMARTLINK	
S32	The SMARTLINK function does not work properly. → Check that your TV complies with SMARTLINK, NextView Link, MEGALOGIC, EASYLINK, Q-Link or EURO VIEW LINK. → Make sure you use the EURO-AV cable, supplied with the VCR, to connect the VCR and your TV. → Make sure the EURO-AV cable is connected securely.
Satellite tuner control	
S33	The Satellite Control function does not work properly. → Be sure to point the VCR remote commander only at the VCR's remote sensor and not at the satellite sensor. → Be sure the Satellite controller is pointing at the Satellite Tuner's remote sensor receiver. → Make sure the Satellite controller is connected securely. → The Satellite tuner brand number may be deleted if you disconnect it from the VCR. Re-enter the Brand code number corresponding to your satellite tuner (see page 29).
S34	You cannot watch the satellite tuner picture when the VCR is in standby mode or ● REC standby mode. → Be sure that the DECODER/LINE-4 is set to LINE4- in OTHER OPTIONS menu (see page 77). → Make sure the POWER SAVE option is set to OFF in the OTHER OPTIONS menu (see page 77).

Index to parts and controls

Refer to the pages indicated in parentheses () for details.

Front panel

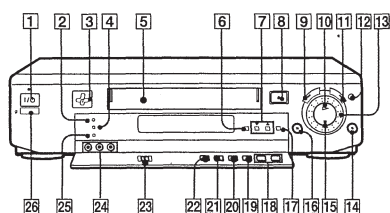

- | | |
|---|--|
| 1 I/O ON/STANDBY button/indicator (6) | 16 ■ PAUSE button (50) |
| 2 SMARTFILE indicator (90) | 17 OK button |
| 3 SMARTFILE sensor (90) | 18 PROGRAM/TRACKING +/- buttons (17), (19), (73) |
| 4 REALITY REGENERATOR (RR) indicator (73) | 19 DIGITAL NOISE REDUCTION button (74) |
| 5 Tape compartment | 20 REALITY REGENERATOR button (73) |
| 6 SMARTFILE button | 21 AUTO SET UP (19)/RF (Radio Frequency) CHANNEL button (17) |
| 7 CURSOR ↑/↓ buttons (90) | 22 SMARTFILE GENERATOR button |
| 8 ▲ EJECT button (50) | 23 COMMAND MODE Switch (7) |
| 9 ◀ REW (rewind) button (50) | 24 LINE-2 IN VIDEO/AUDIO L/R jacks (78) |
| 10 ▷ PLAY button (50) | 25 DIGITAL NOISE REDUCTION (DNR) indicator (74) |
| 11 ▶▶ FF (fast-forward) button (50) | 26 Remote sensor (5) |
| 12 JOG button/indicator (64) | |
| 13 CLICK JOG SHUTTLE ring (64) | |
| 14 ● REC (record) button (52), (79) | |
| 15 ■ STOP button (50) | |

continued

Index to parts and controls (continued)

Display window

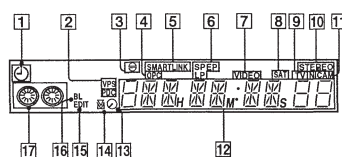

- | | |
|--|--|
| 1 Timer indicator (56), (61) | 9 TV indicator (55) |
| 2 VPS (Video Programme System)/PDC (Programme Delivery Control) indicator (59) | 10 STEREO indicator (70) |
| 3 Audio Dubbing indicator (80) | 11 NICAM indicator (SLV-SF99NP only) (70) |
| 4 OPC (Optimum Picture Control) indicator (73) | 12 Time counter/clock/line/programme position indicator (17), (50), (53) |
| 5 SMARTLINK indicator (13) | 13 Remaining time indicator (54) |
| 6 Tape speed indicators (53) | 14 Tracking indicator (73) |
| 7 VIDEO indicator (53) | 15 EDIT indicator (79) |
| 8 SAT indicator (53) | 16 BL (Blank Time space) indicator (90) |
| | 17 Tape/recording indicator (53) |

Rear panel

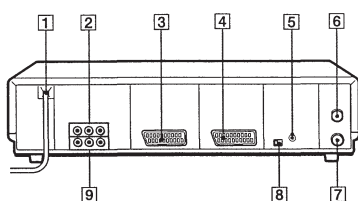

- | | |
|--|--|
| 1 Mains lead (11), (14) | 6 AERIAL IN ANTENNE ENTREE connector (11), (14) |
| 2 LINE-3 IN AUDIO L/R/VIDEO ENTREE LIGNE-3 AUDIO G/D/VIDEO | 7 AERIAL OUT ANTENNE SORTIE connector (11), (14) |
| 3 LINE-1 (TV) LIGNE-1 (TV) connector (11), (44) | 8 NTSC PB (Play Back) switch (49) |
| 4 DECODER/ LINE-4 IN DECODEUR/ ENTREE LIGNE-4 connector (44) | 9 LINE-2 OUT AUDIO L(left)/R (right)/VIDEO SORTIE LIGNE-2 AUDIO G/D/VIDEO (16) |
| 5 SAT CONTROL CONTROLEUR SAT jack (15) | |

continued

Remote commander

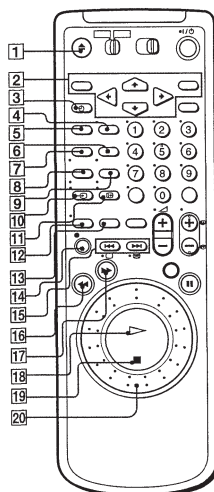

- | |
|--|
| 1 ▲ EJECT button (50) |
| 2 Menu buttons (6) |
| MENU button |
| CURSOR ↑/↓/←/→ buttons |
| OK button |
| 3 ⌚ TIMER button (56), (61) |
| 4 AUDIO MONITOR button (6), (70) |
| 5 CLEAR button (49), (56), (68) |
| 6 AUDIO DUB button* (80) |
| 7 COUNTER/REMAIN button* (54) |
| 8 Fasttext button* |
| 9 Fasttext button* |
| 10 TV/VIDEO button (6) |
| 11 DISPLAY button (54) |
| 12 WIDE button (for TV) (7) |
| 13 SP (Standard Play)/LP (Long Play) button (52) |
| 14 ● REC (record) button (52), (67), (79) |
| 15 ◀▶▶ INDEX SEARCH buttons (72) |
| ○ TV power on/TV mode select button (for TV) (7) |
| ☐ (Teletext) button (for TV) (7) |
| 16 ◀ REW (rewind) button (50), (64) |
| 17 ▶▶ FF (fast-forward) button (50), (64) |
| 18 ▷ PLAY button (50), (64) |
| 19 ■ STOP button (50), (67) |
| 20 Shuttle ring (64) |
| * FASTTEXT buttons (for TV) |

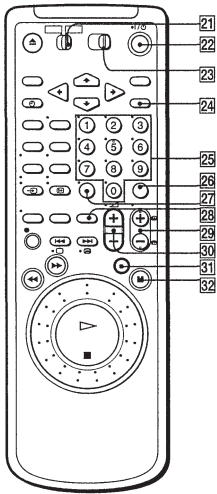

- 21 TV/VIDEO remote control switch (5)
- 22 I/⏻ (on/standby) button (6), (61)
- 23 COMMAND MODE Switch (7)
- 24 SMARTFILE button (85)
- 25 Programme number buttons (6), (27)
- 26 SAT button (27)
- 27 -- (ten's digit) button (6), (54)
- 28 INPUT SELECT button (53), (61)
- 29 PROG (programme) +/- buttons (6), (35) (53)
- 30 [A] [TV] Teletext page access buttons (for TV) (7)
- 31 [V] (volume) +/- buttons (for TV) (6)
- 32 [II] PAUSE button (50), (65)

Menu chart

This VCR is equipped with an on-screen indication system which allows you a visual, quick and easy selection of the different menus. For a total view of all the menus, please refer to the following chart.

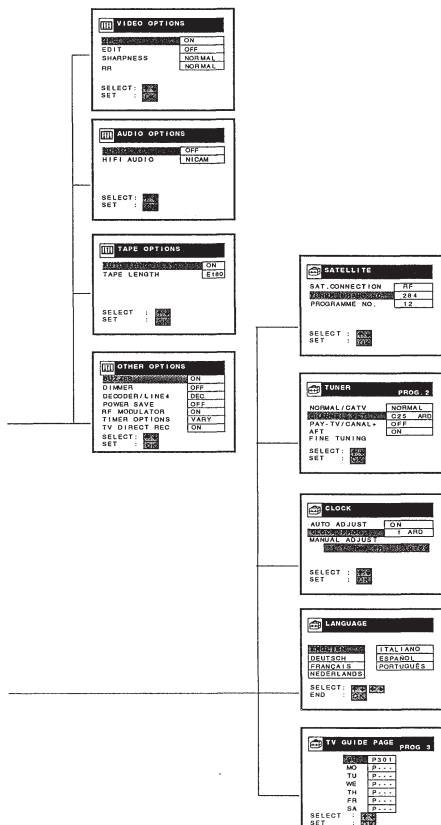
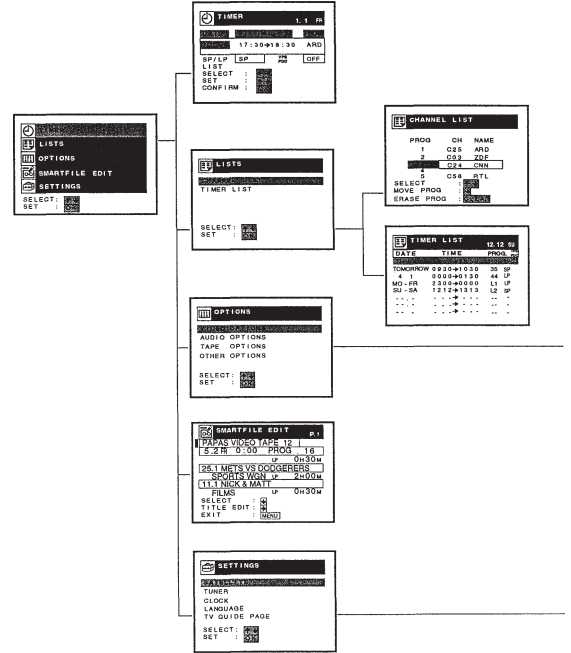

SECTION 2 DISASSEMBLY

NOTE: Follow the disassembly procedure in the numerical order given.

2-1. CASE, FRONT PANEL BLOCK ASSEMBLY

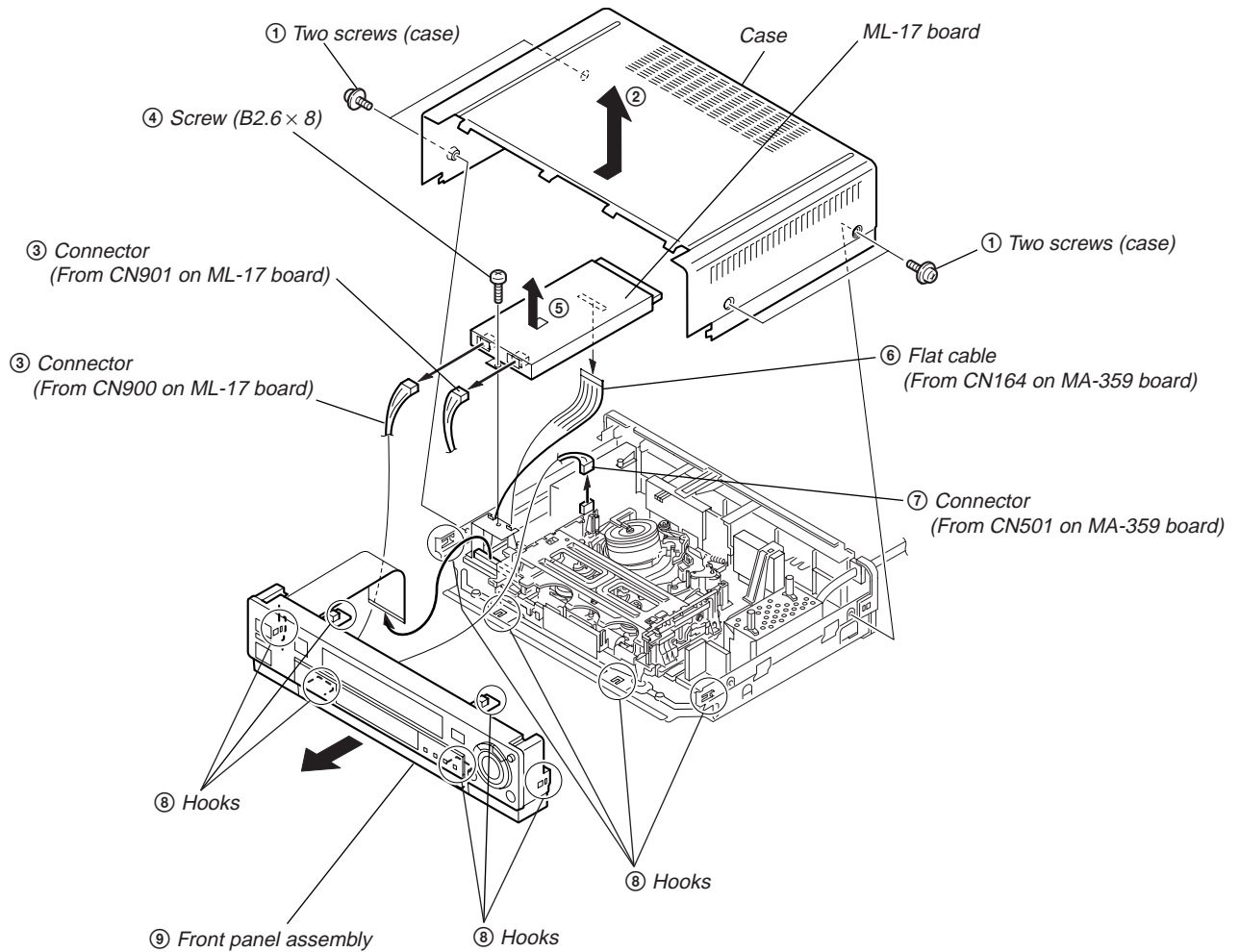

2-2. DM-86, FR-161, JK-171, AT-26 BOARDS

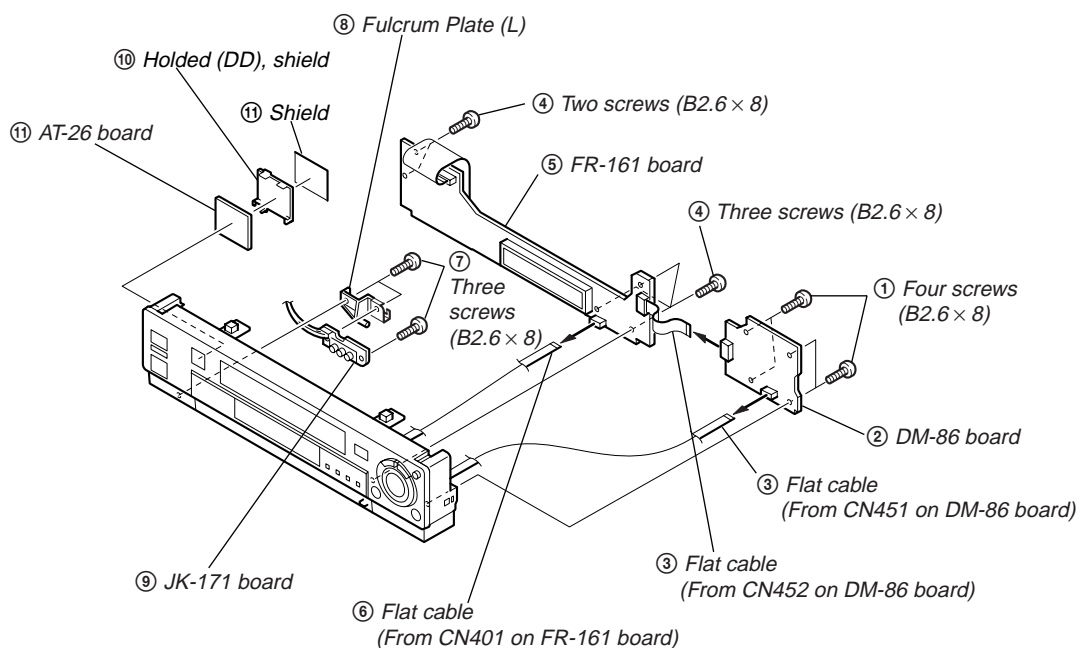

2-3. REAR PANEL

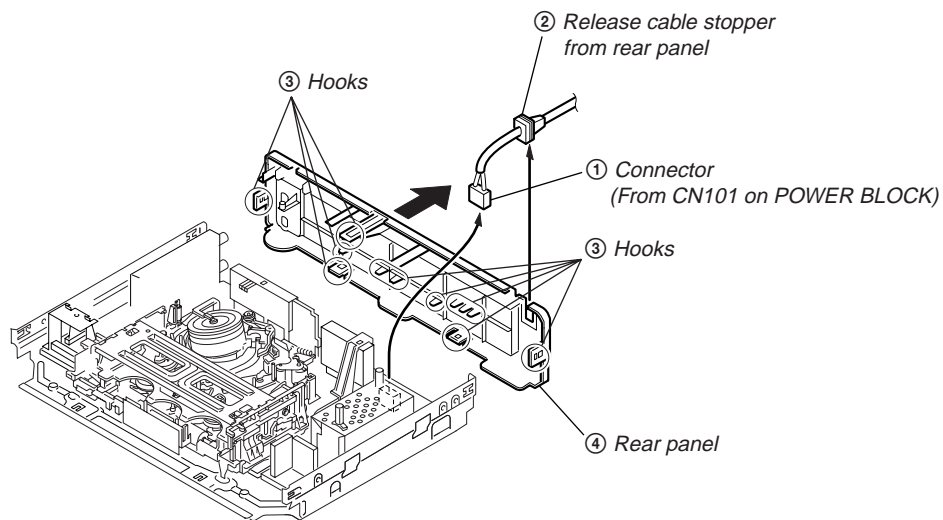

2-4. NR-27, RP-235 BOARDS

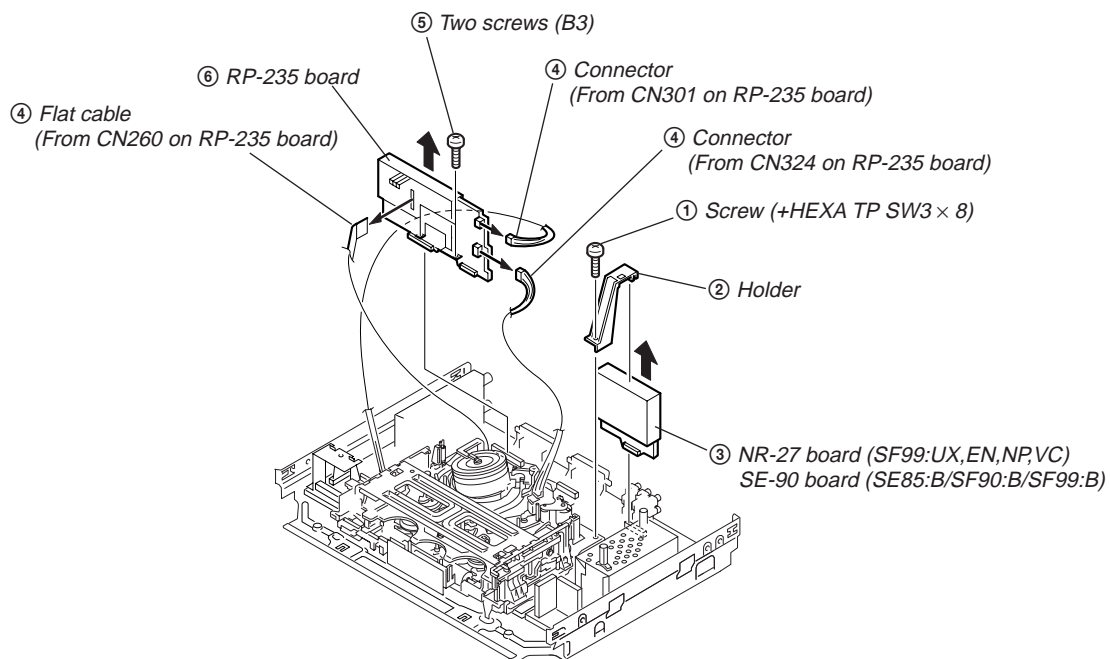

2-5. SR MECHANISM DECK

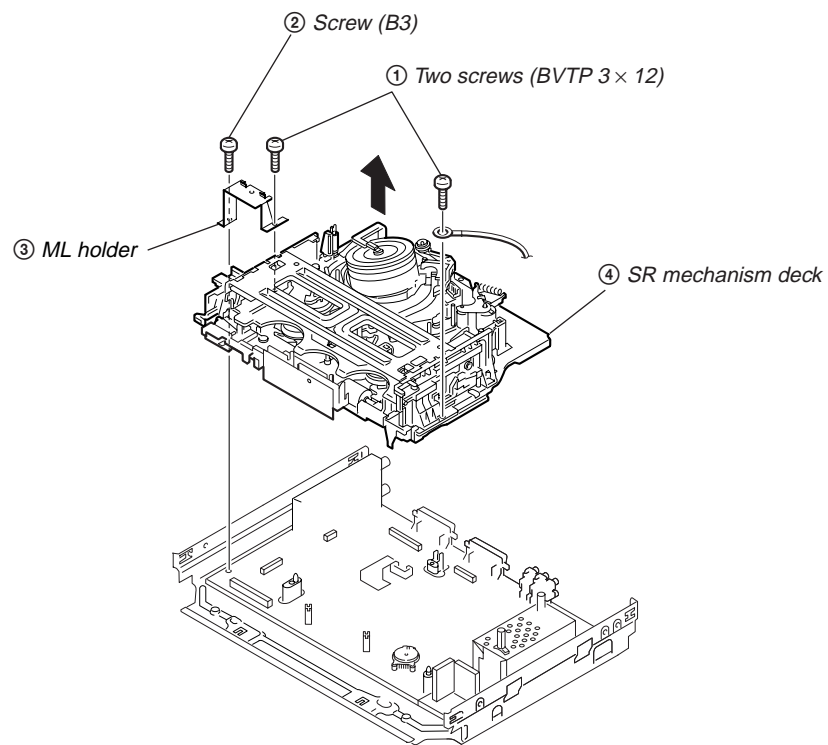

2-6. POWER BLOCK, MA-359 BOARDS

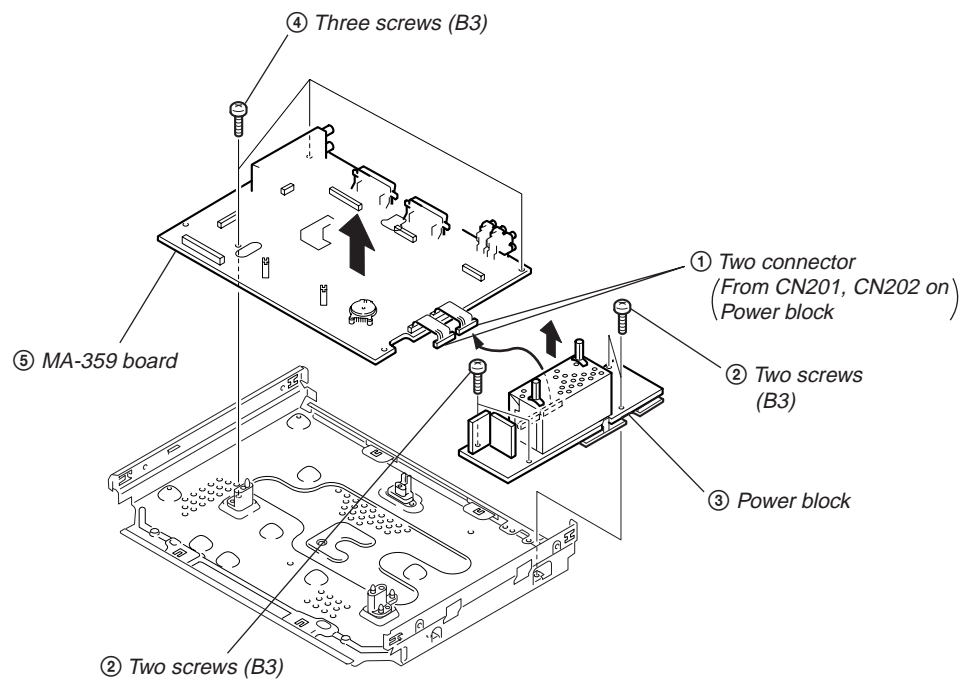

2-7. INTERNAL VIEWS

— Top View —

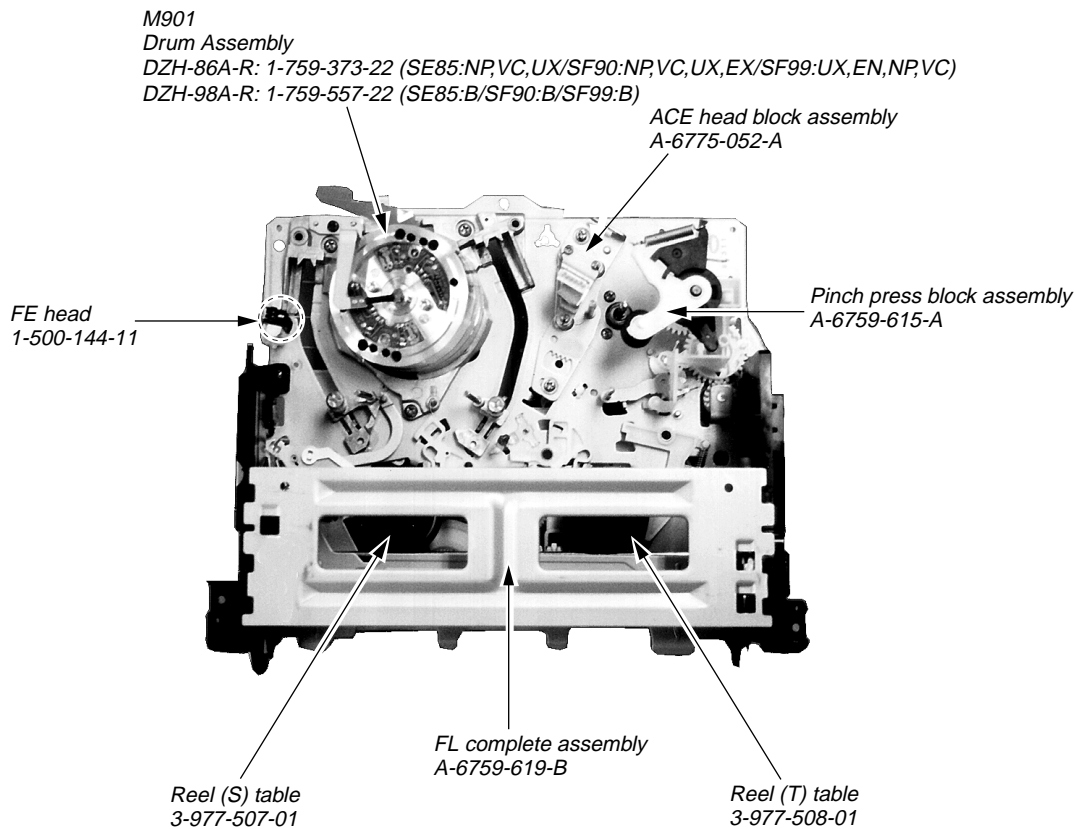

— Bottom View —

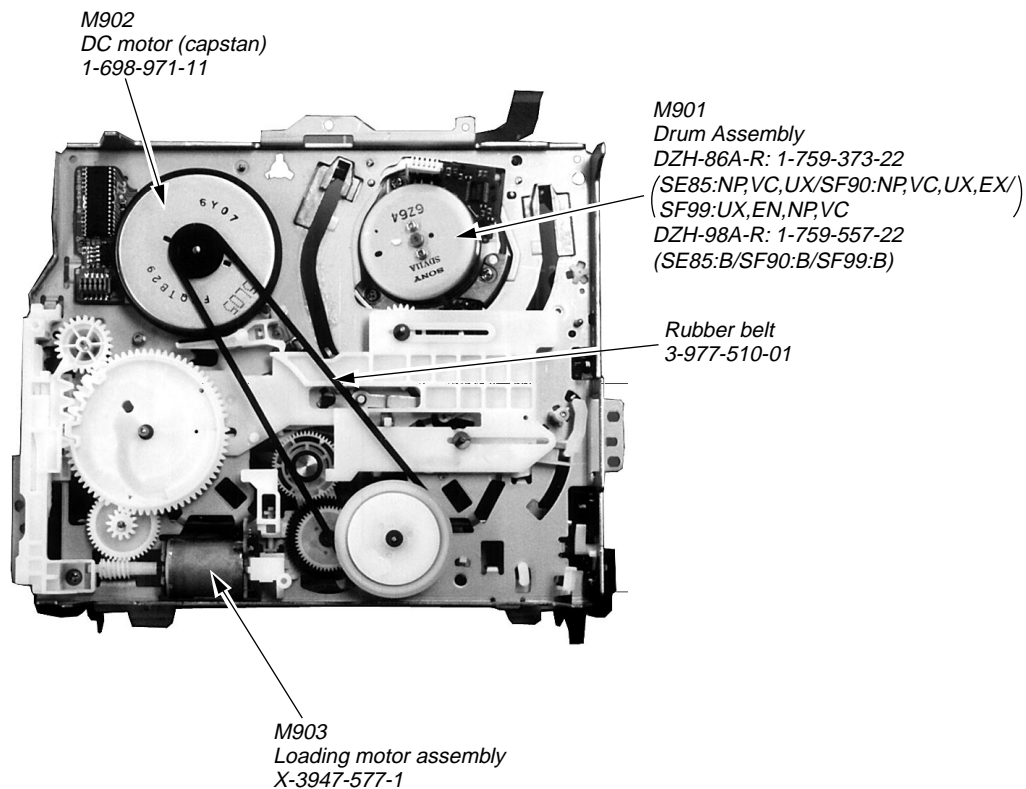

2-8. CIRCUIT BOARDS LOCATION

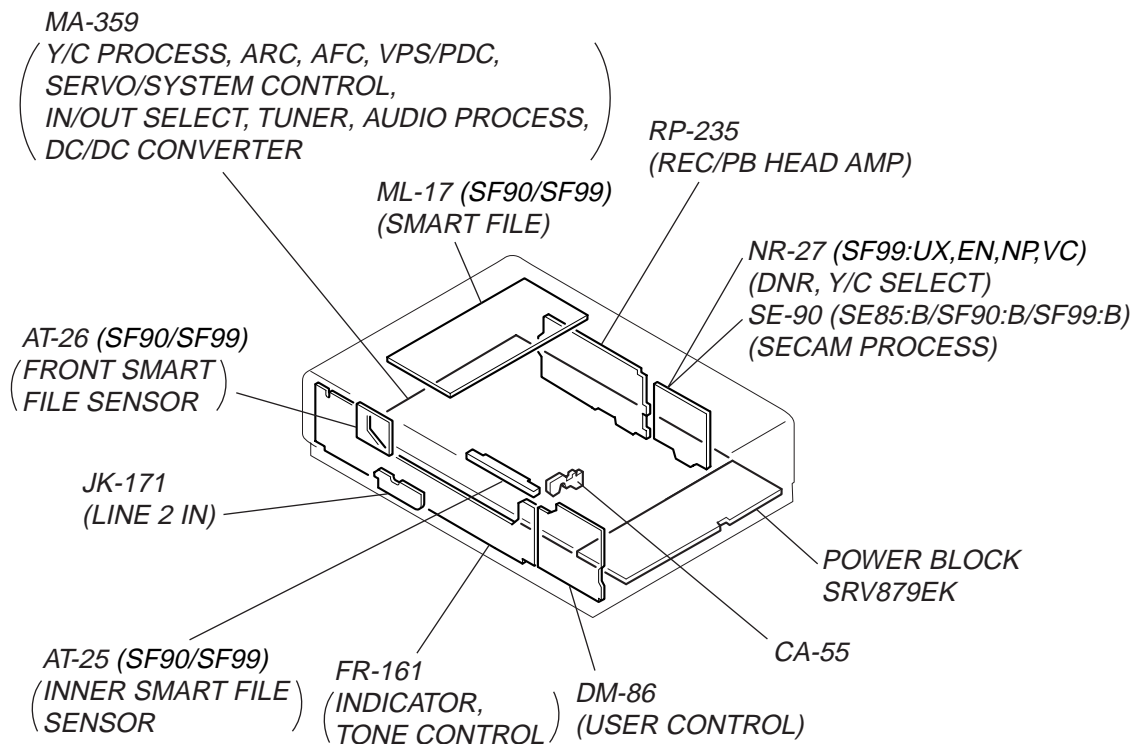

**SECTION 3
BLOCK DIAGRAMS**

SLV-SE85/SF90/SF99

3-1. OVERALL BLOCK DIAGRAM (1)

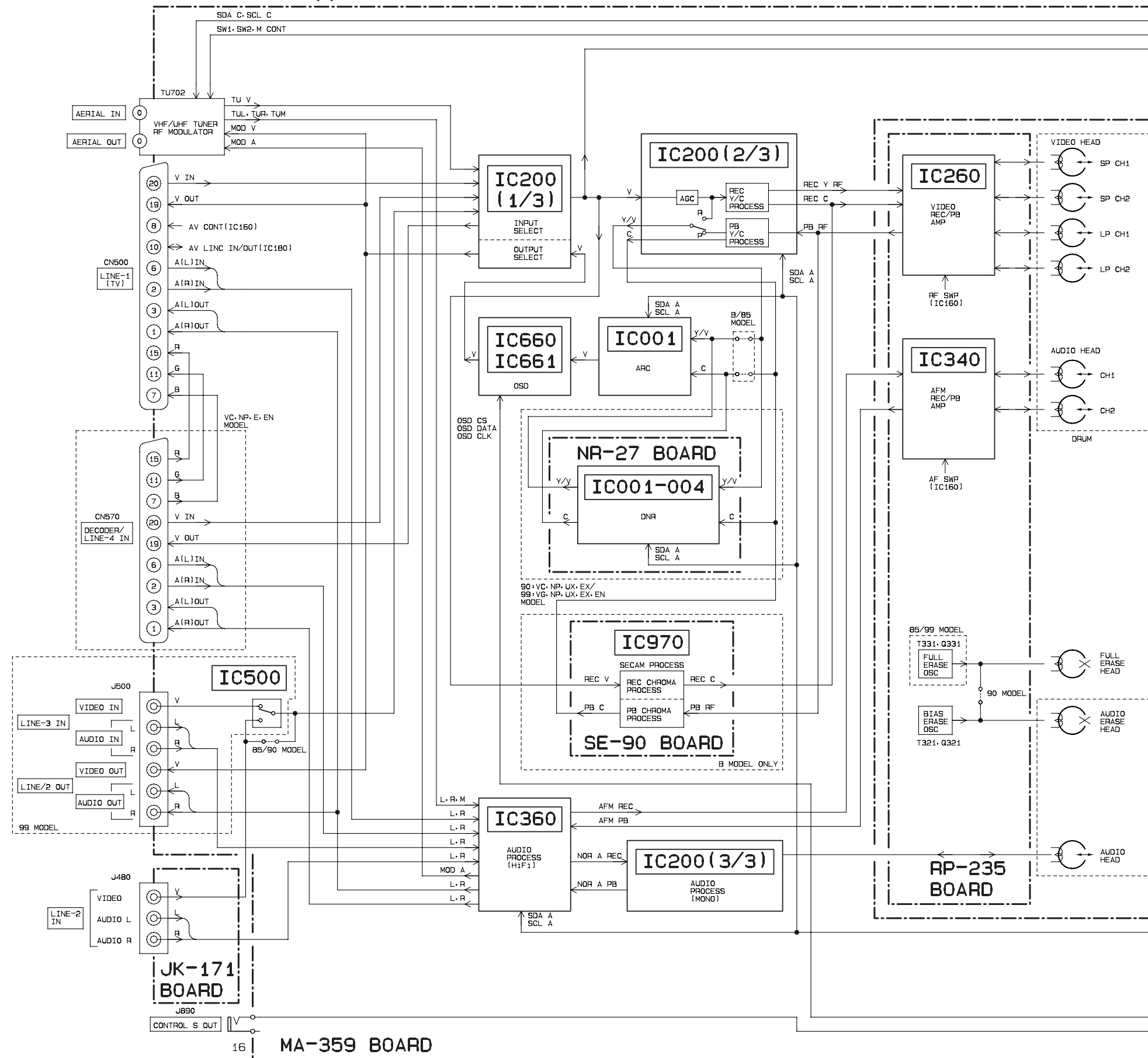

OVERALL BLOCK DIAGRAM (2)

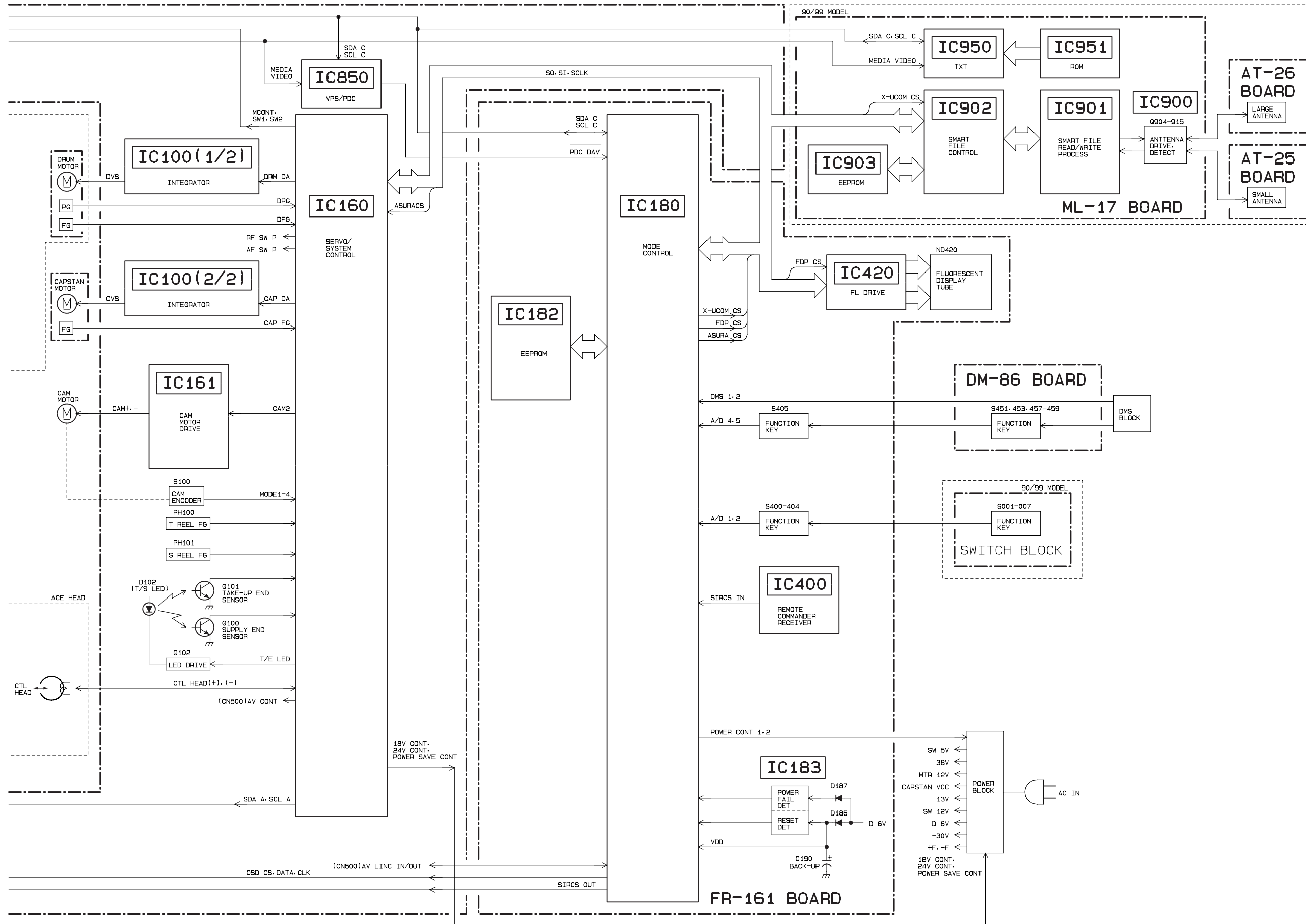

VIDEO BLOCK DIAGRAM (2)

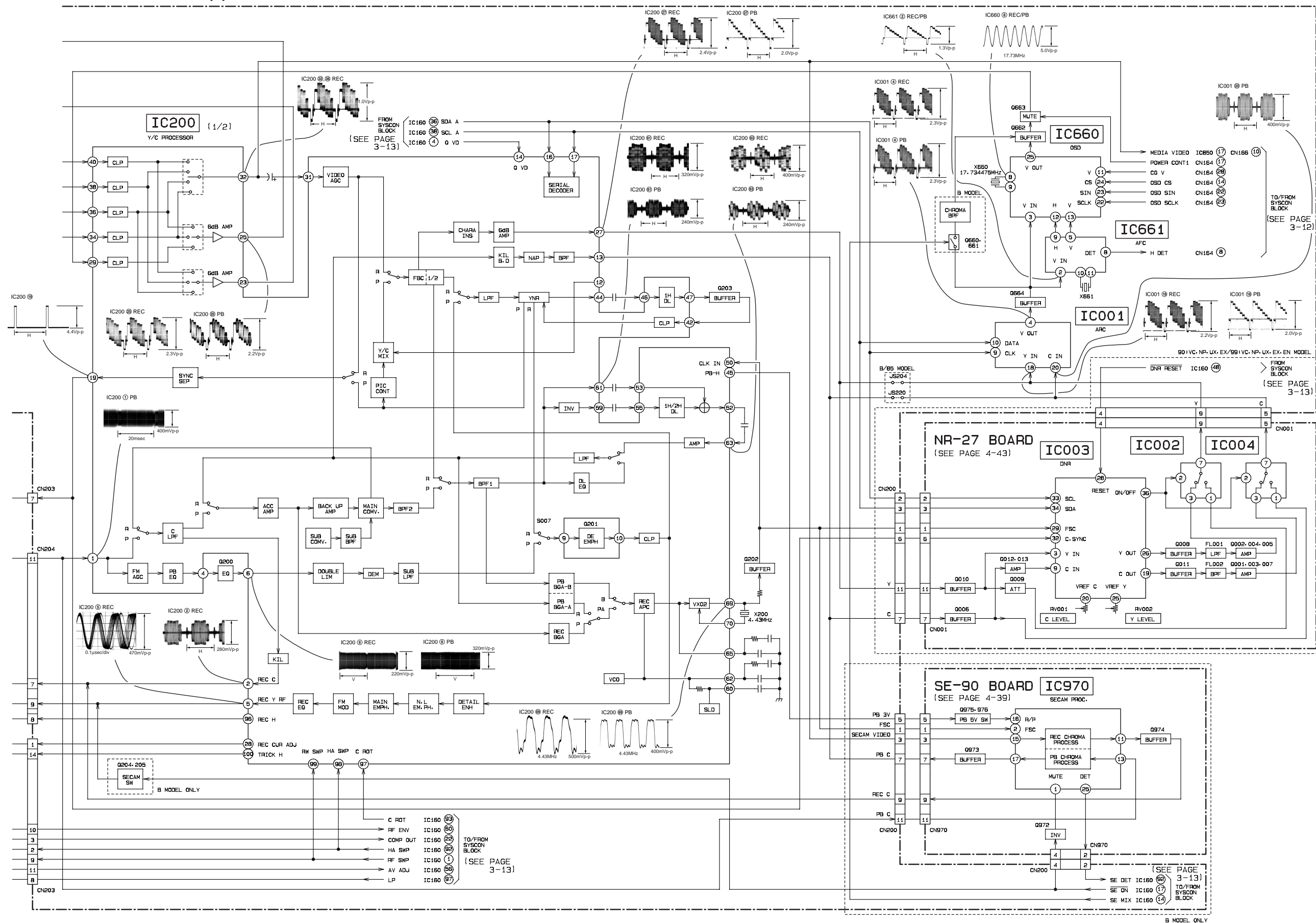

3-3. SERVO BLOCK DIAGRAM (1)

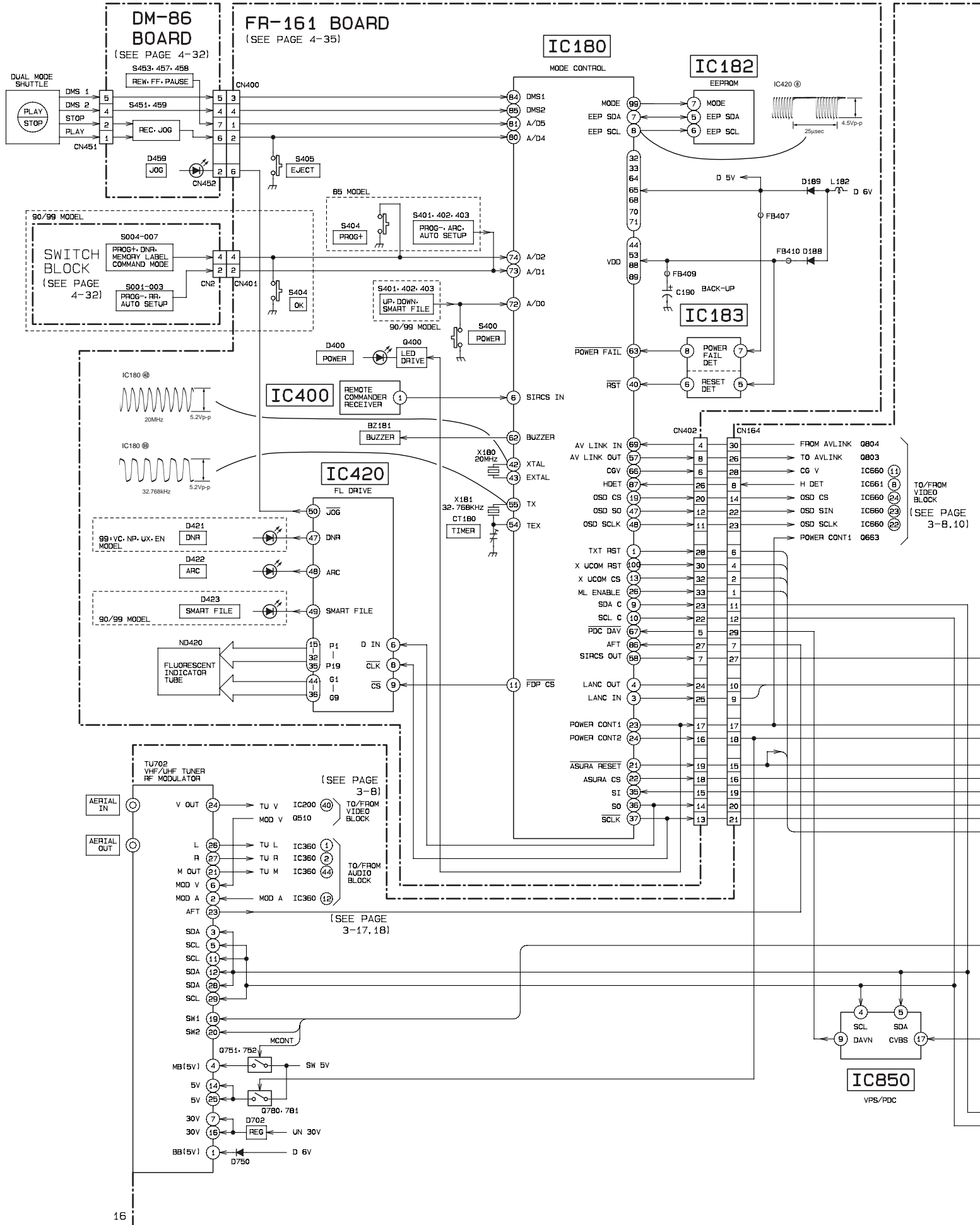

SERVO BLOCK DIAGRAM (2)

MA-359 BOARD
(SEE PAGE 4-7.9.13)

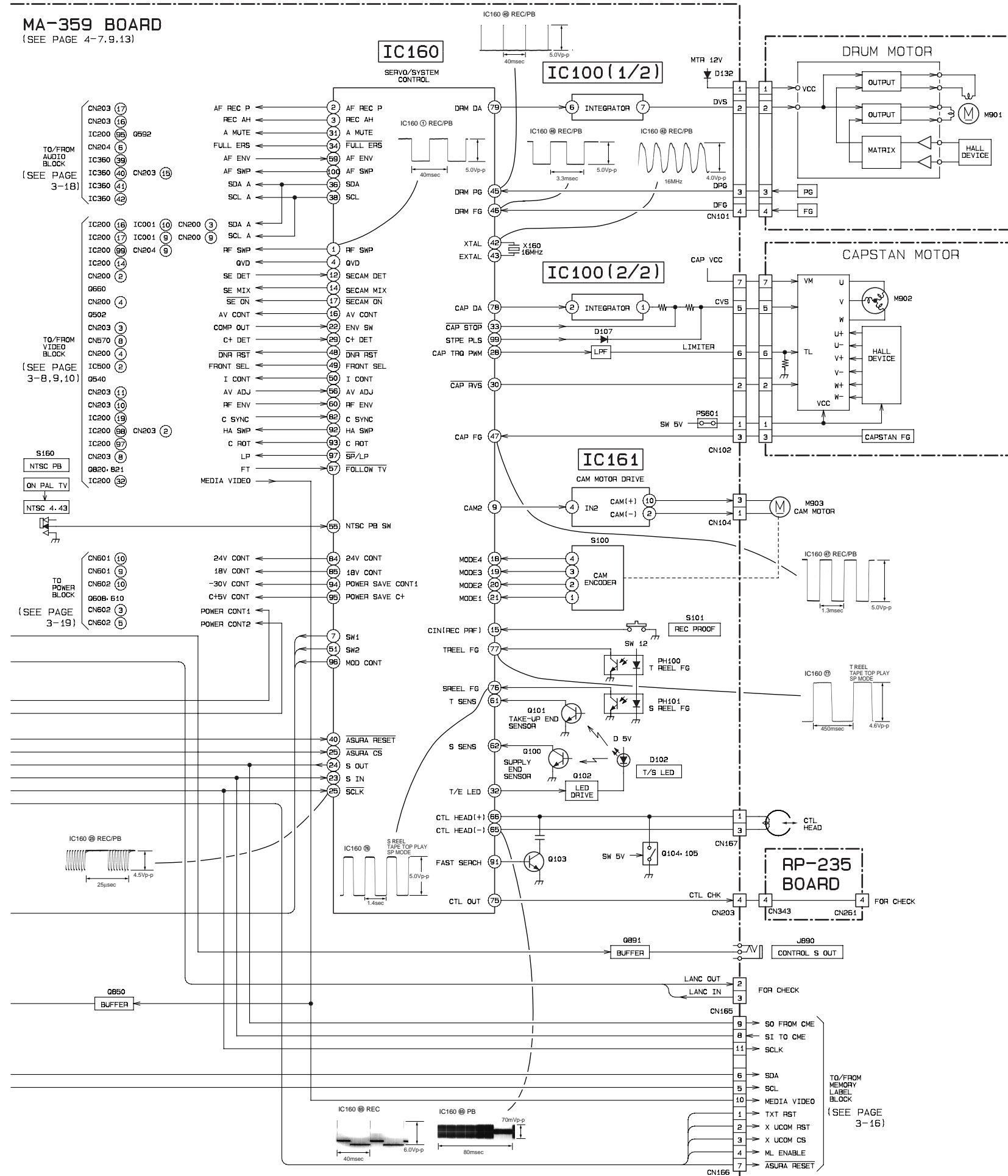

3-4. MEMORY BLOCK DIAGRAM

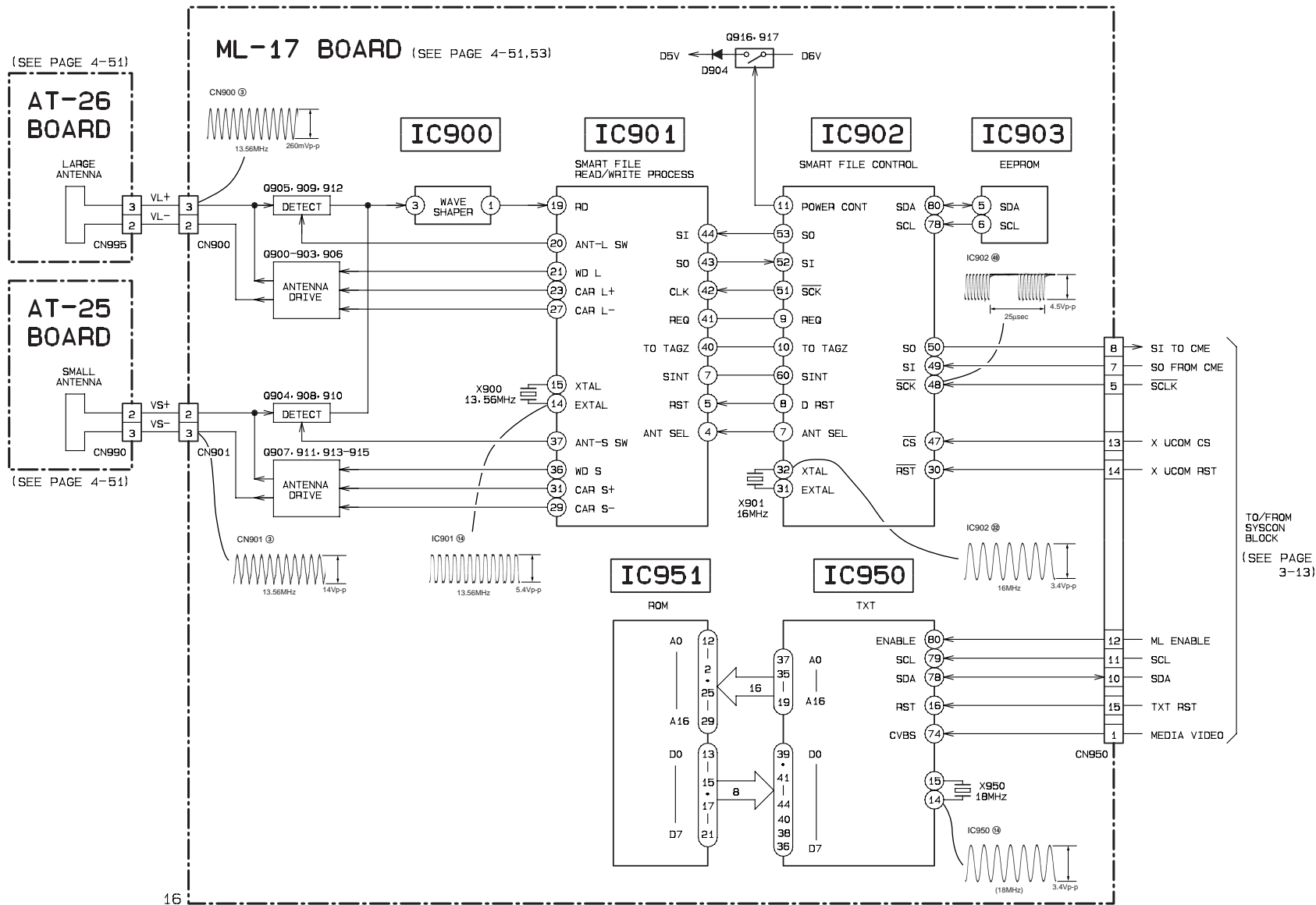

3-5. AUDIO BLOCK DIAGRAM

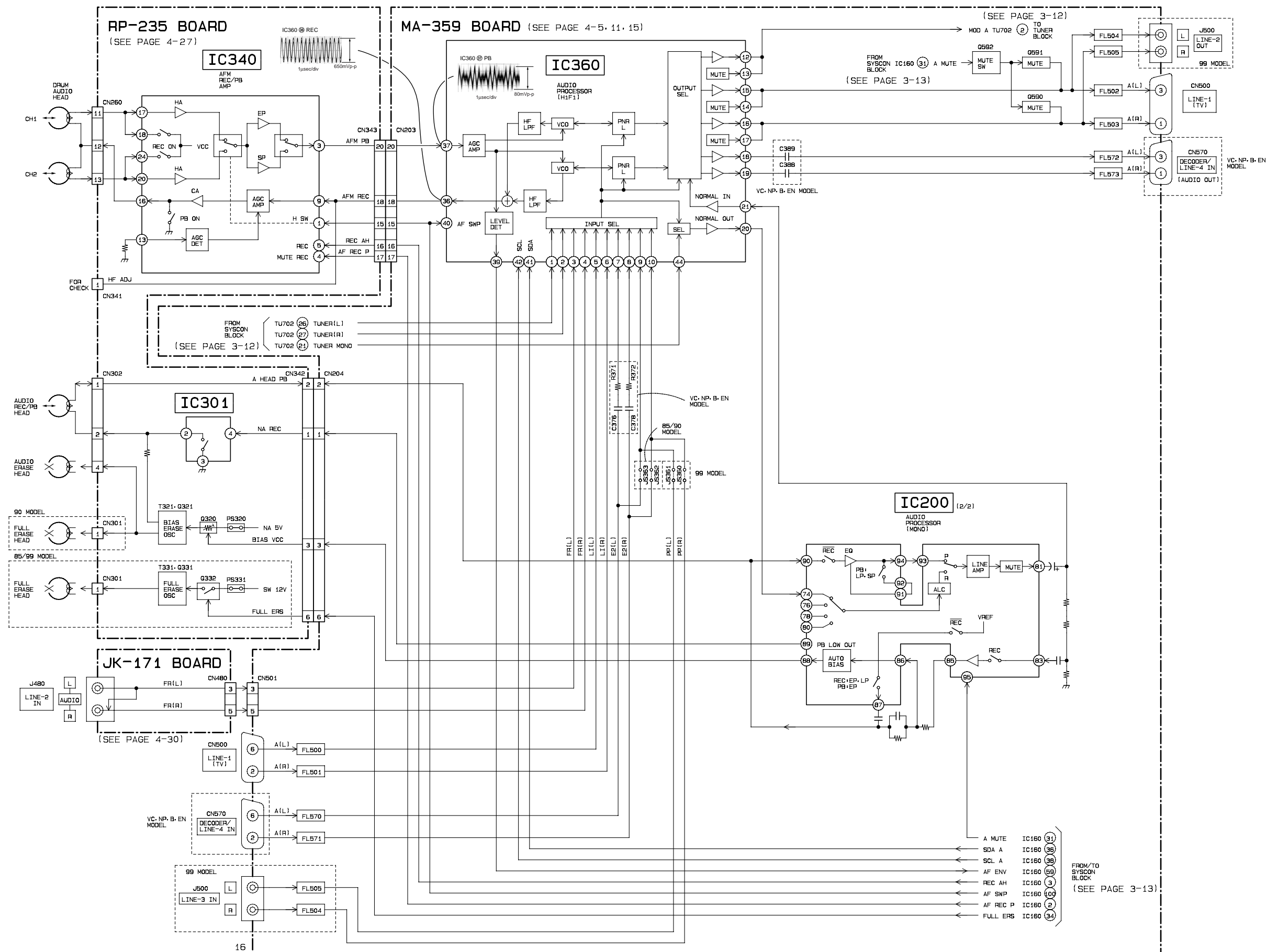

3-6. POWER BLOCK DIAGRAM (1)

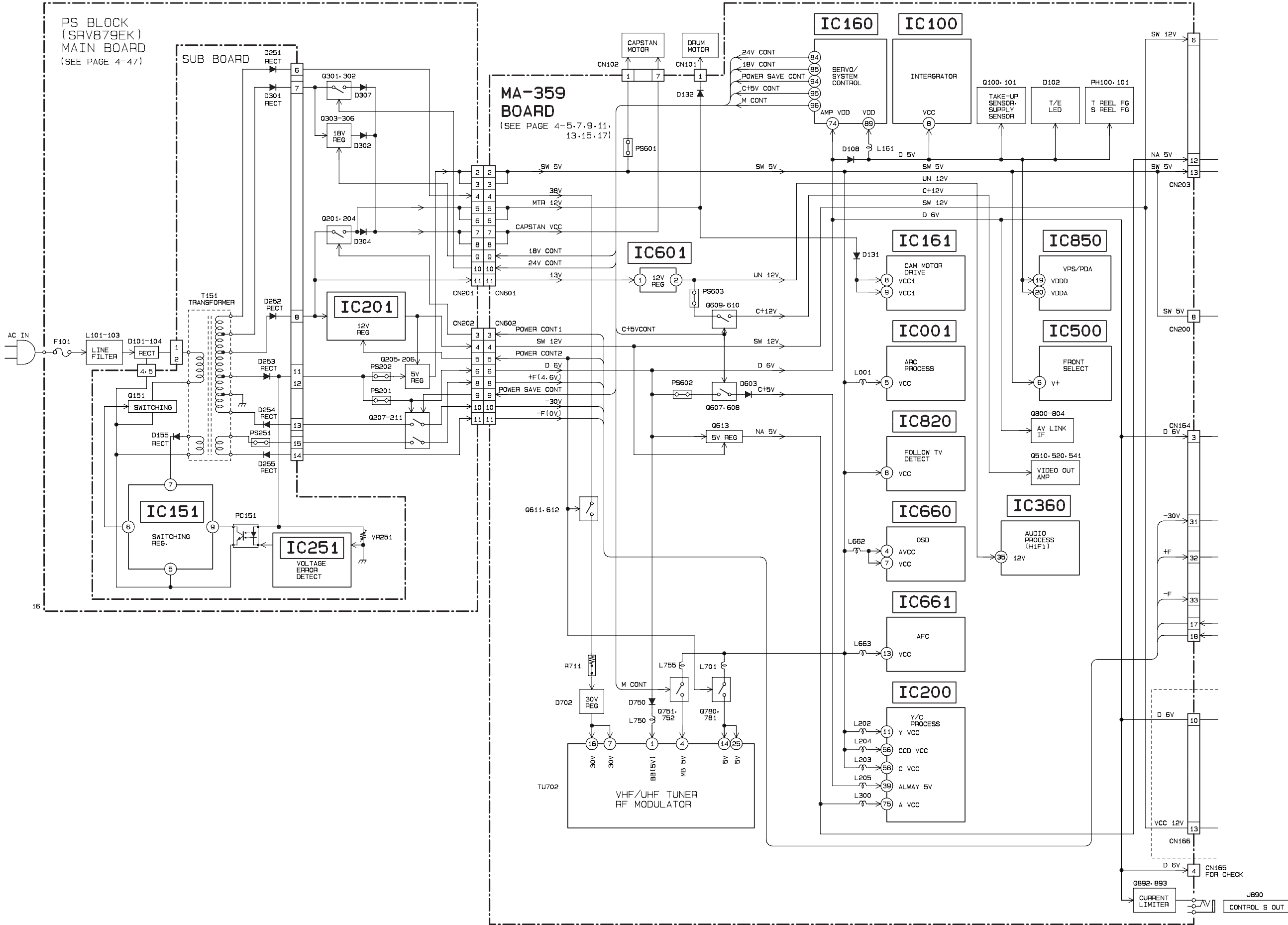

POWER BLOCK DIAGRAM (2)

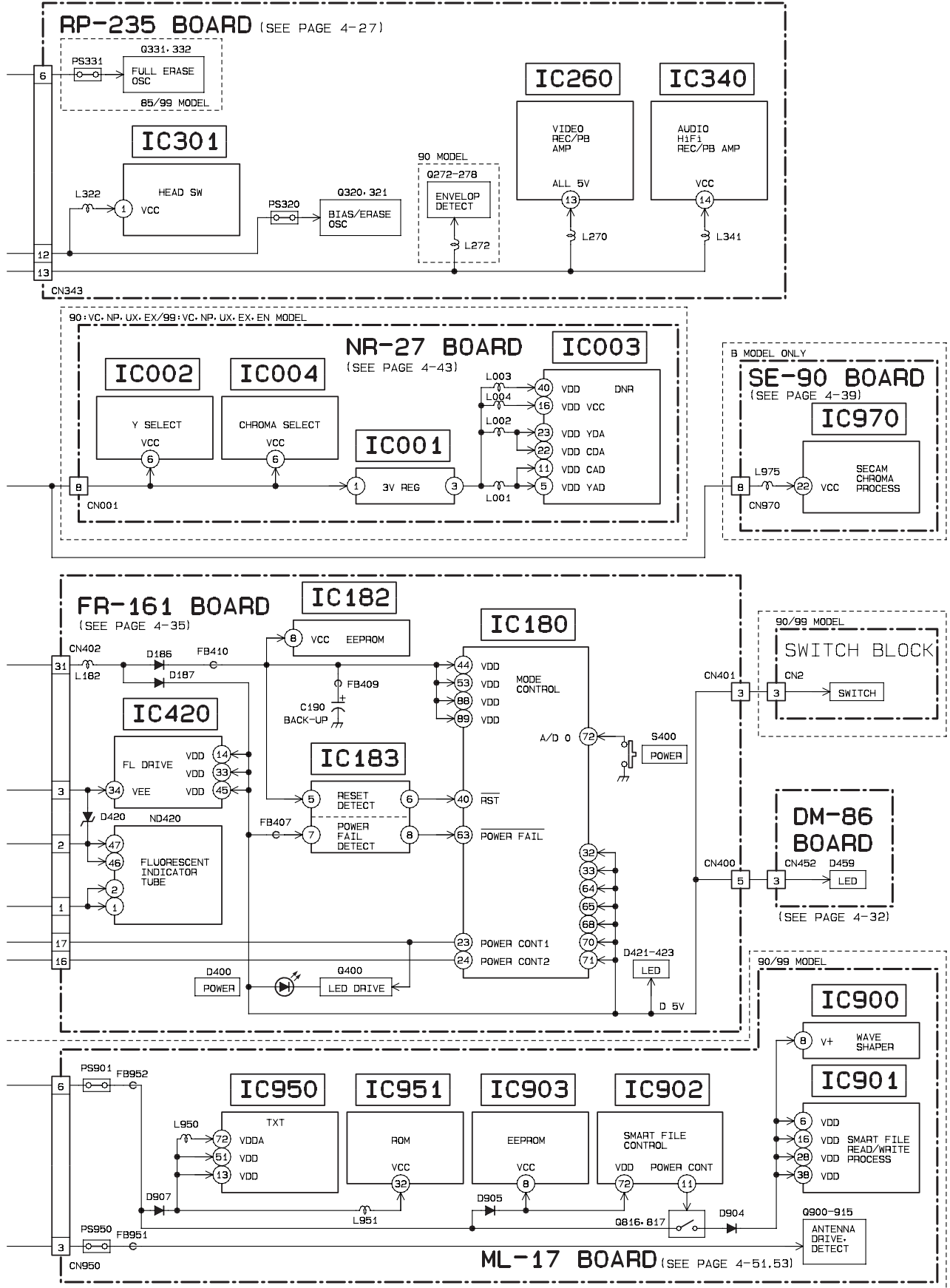

SECTION 4 PRINTED WIRING BOARDS AND SCHEMATIC DIAGRAMS

**THIS NOTE IS COMMON FOR PRINTED WIRING BOARDS AND SCHEMATIC DIAGRAMS.
(In addition to this, the necessary note is printed in each block.)**

(For printed wiring boards)



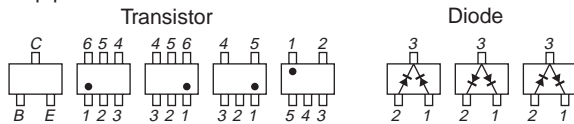



- : Pattern from the side which enables seeing.
(The other layers' patterns are not indicated.)
- Through hole is omitted.
- Circled numbers refer to waveforms.
- There are few cases that the part printed on diagram isn't mounted in this model.
- Chip parts.

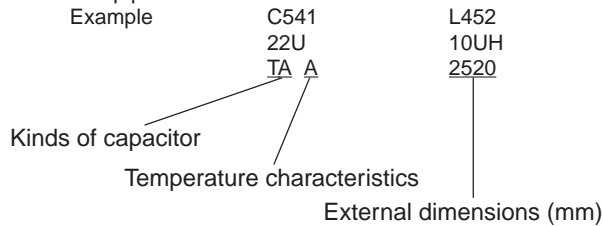

(For schematic diagrams)

- All capacitors are in μF unless otherwise noted. $\text{pF} : \mu\mu\text{F}$. 50V or less are not indicated except for electrolytics and tantalums.
- Chip resistors are 1/10W unless otherwise noted. $\text{k}\Omega=1000\Omega$, $\text{M}\Omega=1000\text{k}\Omega$.
- Caution when replacing chip parts.
New parts must be attached after removal of chip.
Be careful not to heat the minus side of tantalum capacitor, Because it is damaged by the heat.
- Some chip part will be indicated as follows.



- Constants of resistors, capacitors, ICs and etc with XX indicate that they are not used.
In such cases, the unused circuits may be indicated.
- Parts with ★ differ according to the model/destination.
Refer to the mount table for each function.
- All variable and adjustable resistors have characteristic curve B, unless otherwise noted.
- Signal name
XEDIT → EDIT PB/XREC → PB/REC
-  : non flammable resistor
-  : fusible resistor
-  : panel designation
-  : internal component.
-  : B+ Line.
-  : B- Line.
- Circled numbers refer to waveforms.
- Readings are taken with a color-bar signal input.
- Voltage are dc between ground and measurement points.
- Readings are taken with a digital multimeter (DC10M Ω).
- Voltage variations may be noted due to normal production tolerances.
-  : adjustment for repair.
- Circled numbers refer to waveforms.

When indicating parts by reference number, please include the board name.

Note :
The components identified by mark Δ or dotted line with mark Δ are critical for safety.
Replace only with part number specified.

Note :
Les composants identifiés par une marque Δ sont critiques pour la sécurité.
Ne les remplacer que par une pièce portant le numéro spécifié.

4-1. FRAME SCHEMATIC DIAGRAM

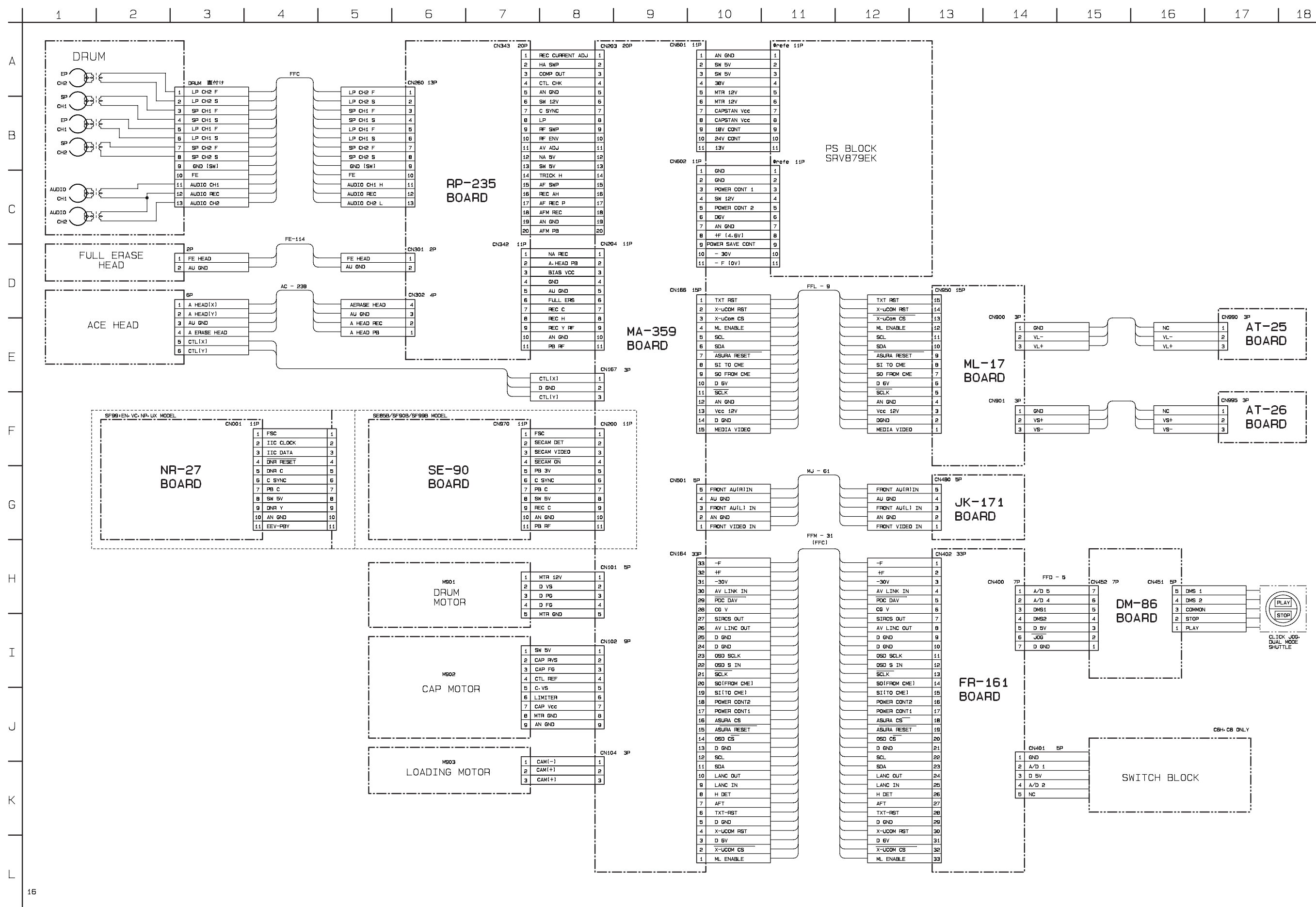

For schematic diagram

- Refer to page 4-19 for printed wiring board.
- Refer to page 4-21 for waveforms.

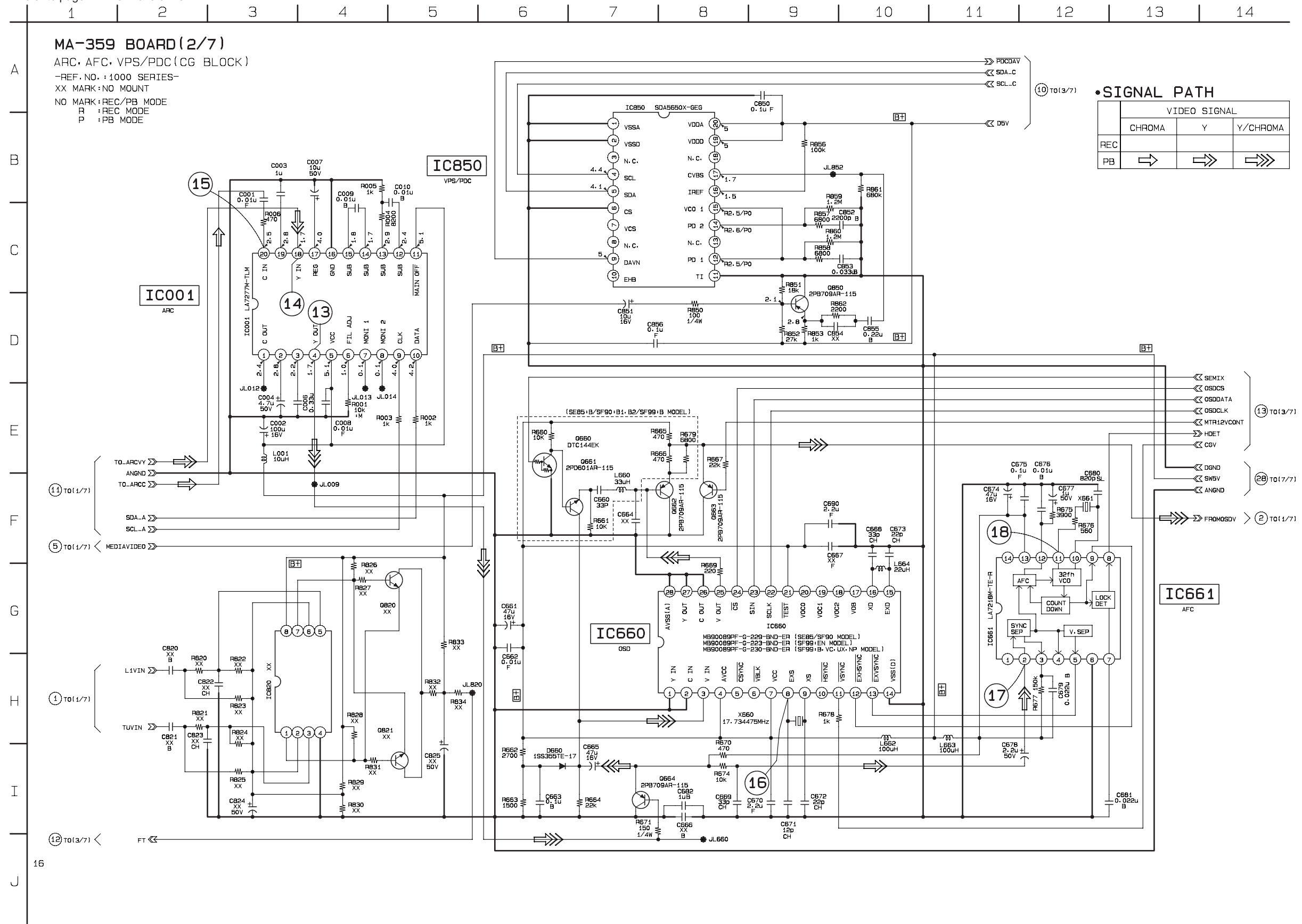

For schematic diagram
 • Refer to page 4-19 for printed wiring board.
 • Refer to page 4-22 for waveforms.

1 2 3 4 5 6 7 8 9 10 11 12 13 14 15 16 17 18 19 20 21

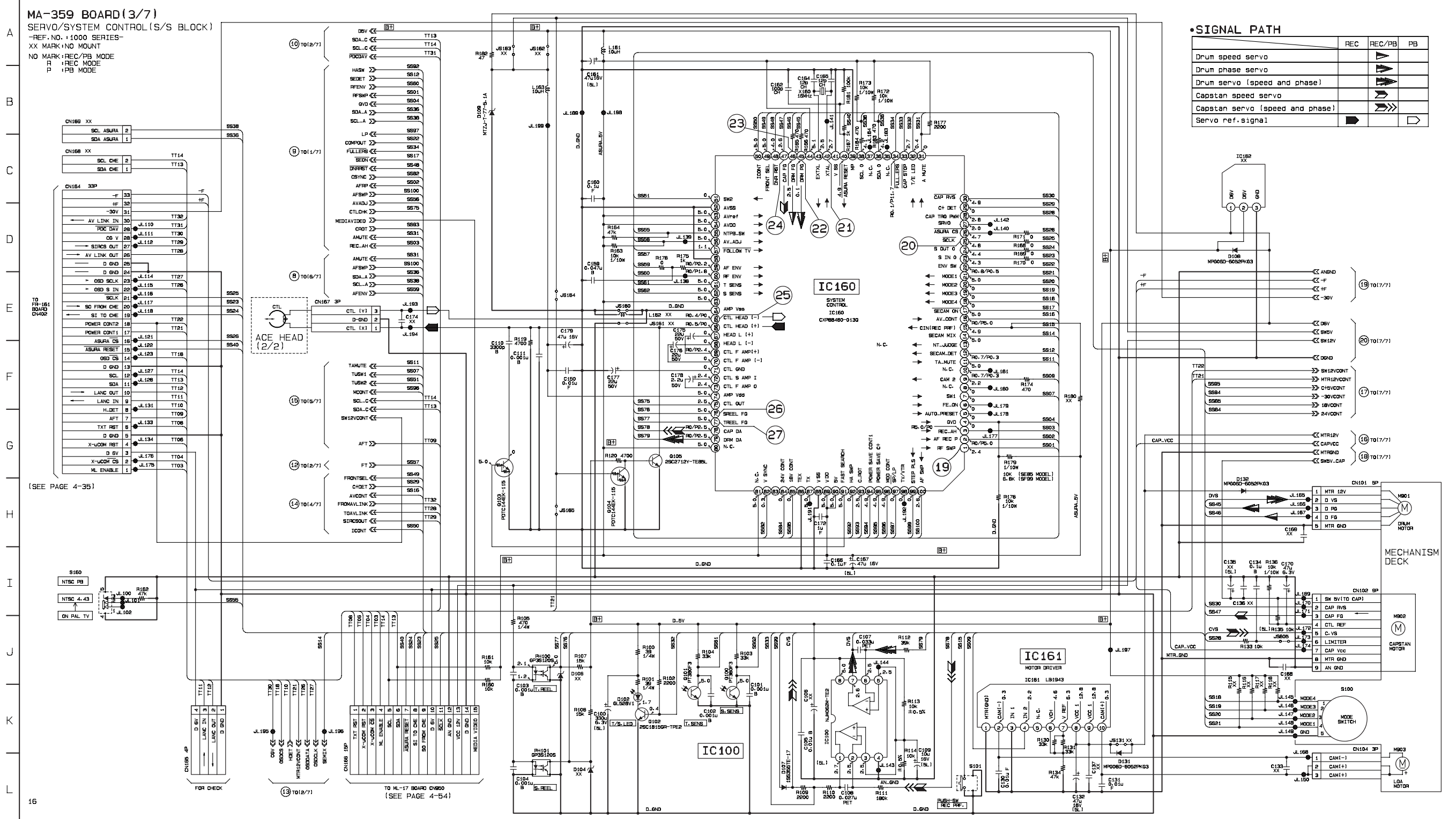

For schematic diagram

- Refer to page 4-19 for printed wiring board.
- Refer to page 4-22 for waveforms.

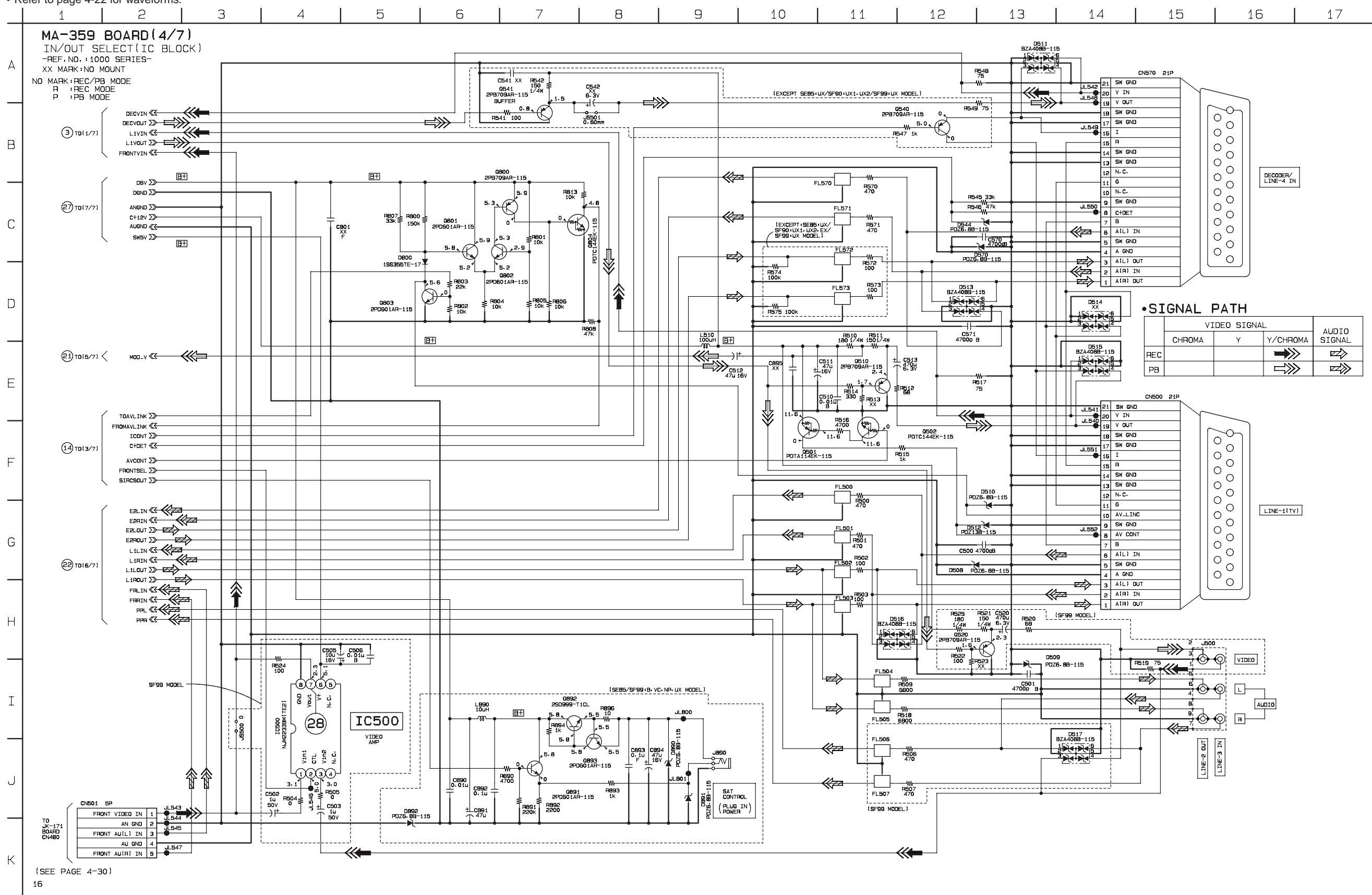

For schematic diagram
 • Refer to page 4-19 for printed wiring board.

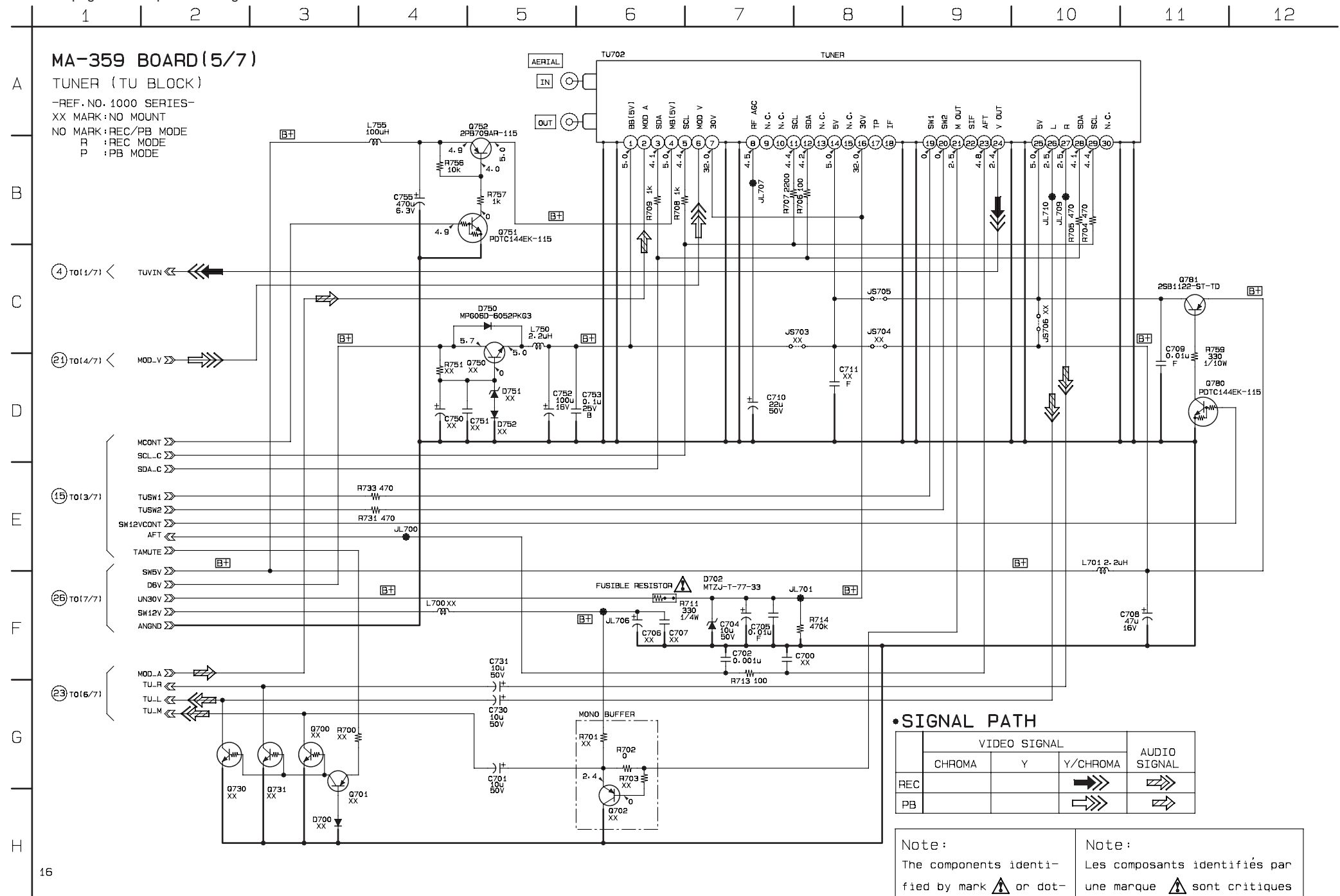

For schematic diagram

- Refer to page 4-19 for printed wiring board.
- Refer to page 4-22 for waveforms.

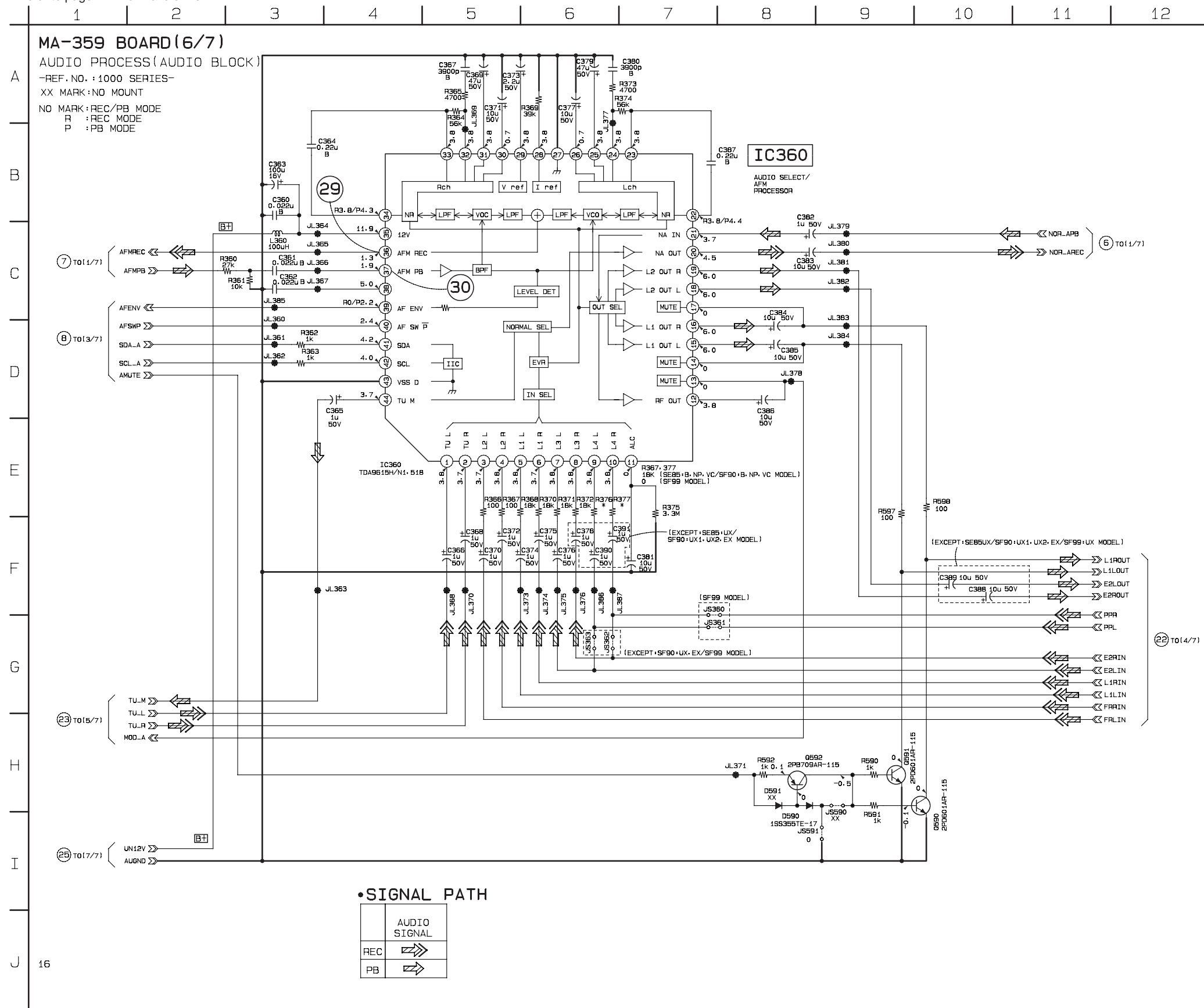

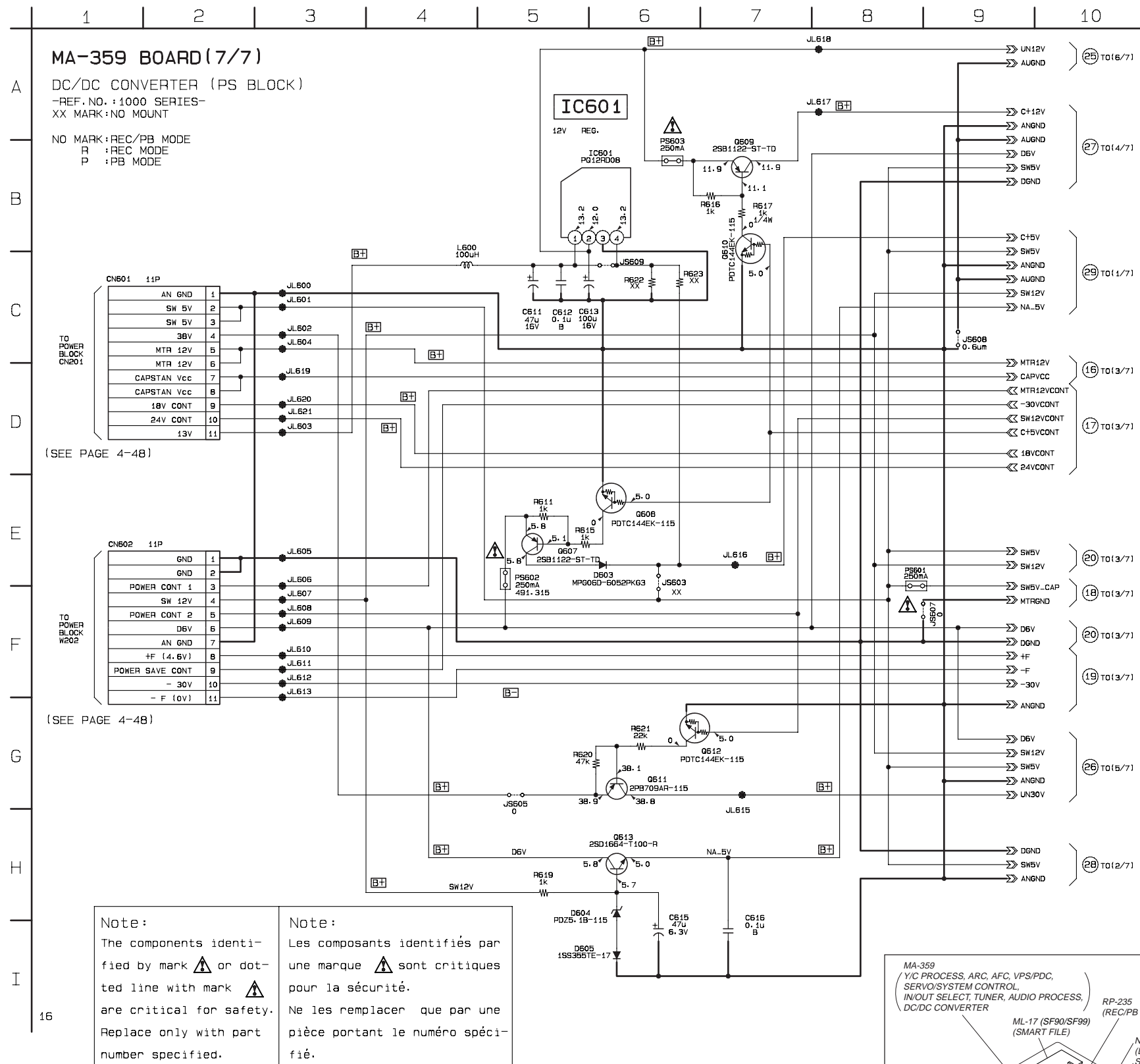

Note:
 The components identified by mark or dotted line with mark are critical for safety. Replace only with part number specified.

Note:
 Les composants identifiés par une marque sont critiques pour la sécurité. Ne les remplacer que par une pièce portant le numéro spécifié.

For printed wiring boards
 There are few cases that the part printed on this diagram isn't mounted in this model.

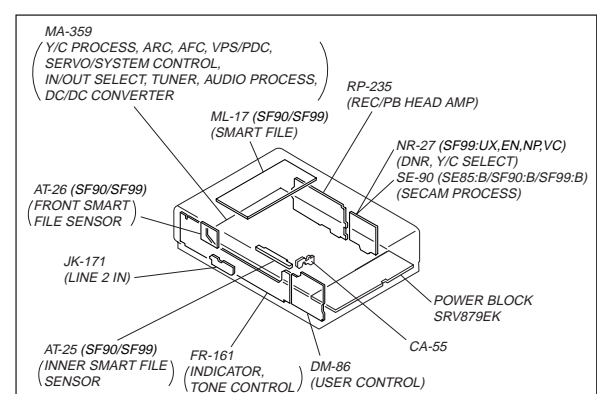

MA-359 BOARD (1/7)

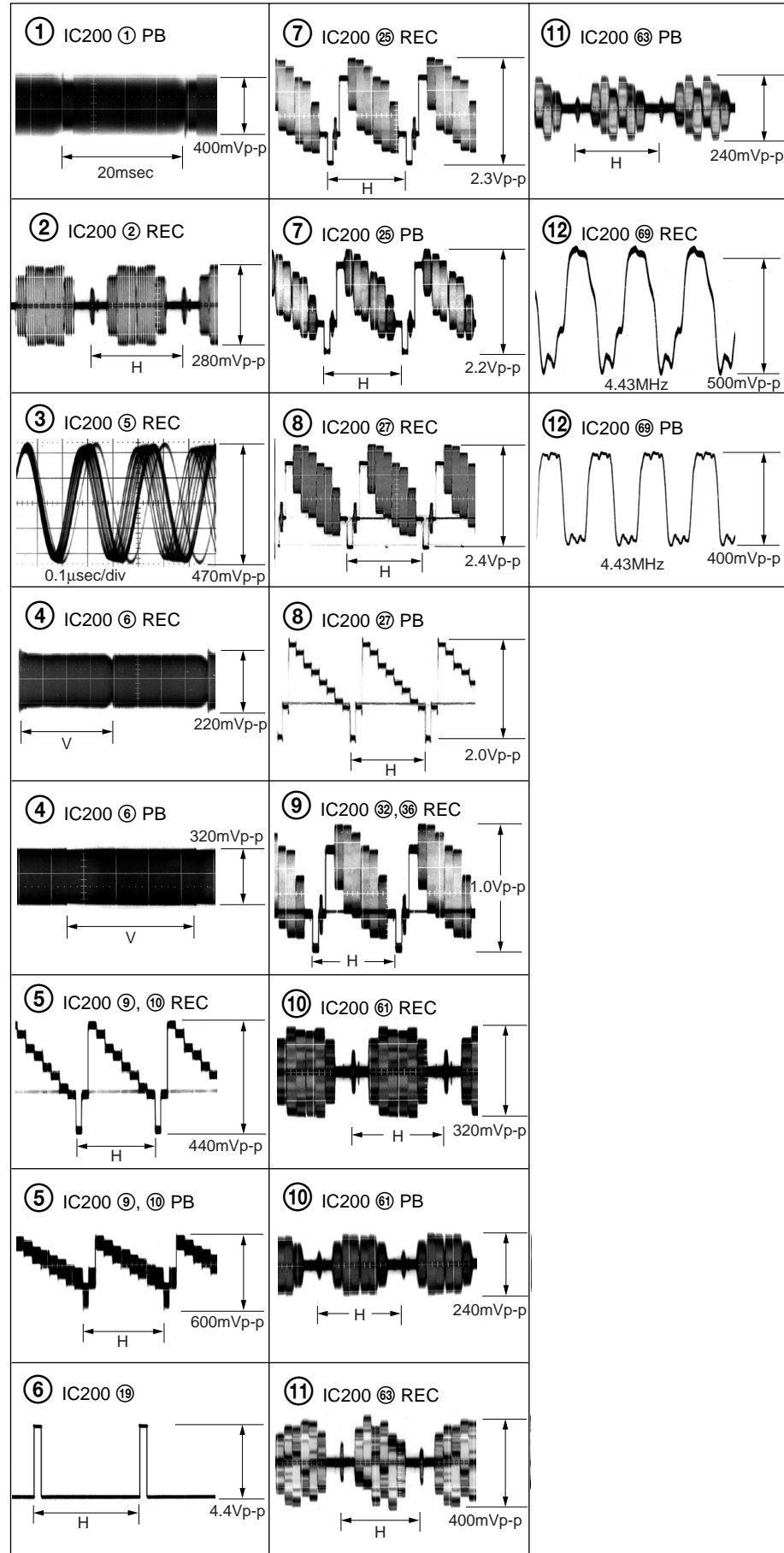

(2/7)

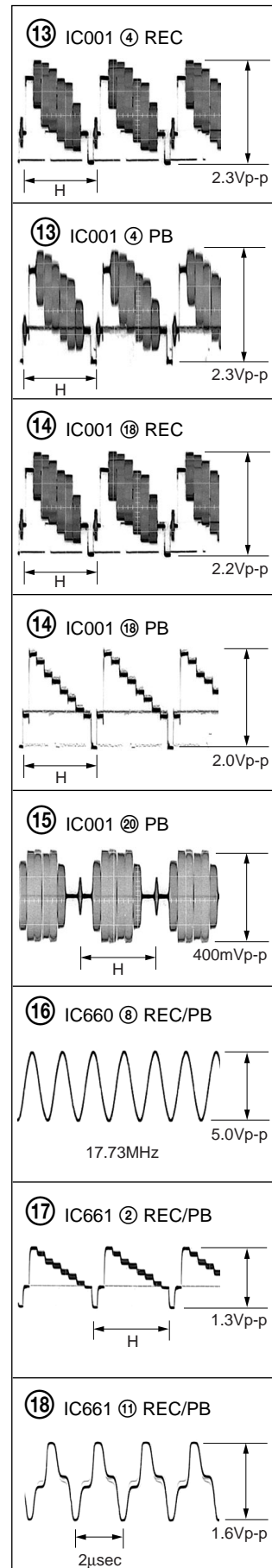

(3/7)

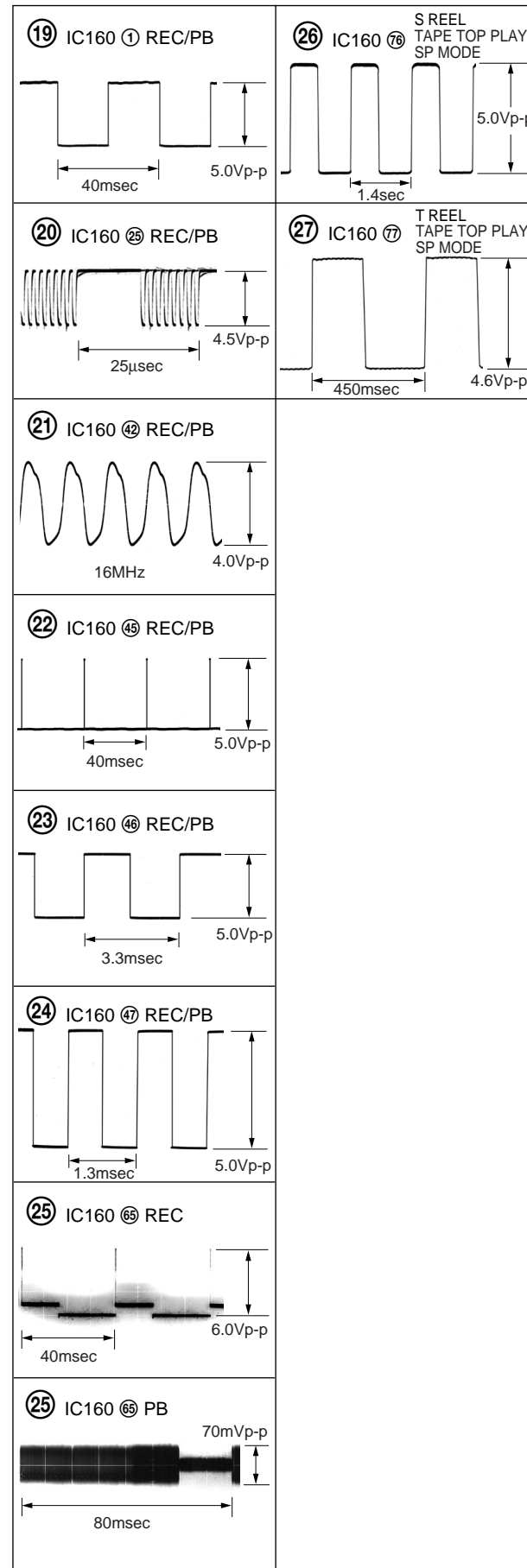

(4/7)

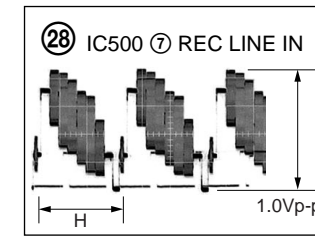

(6/7)

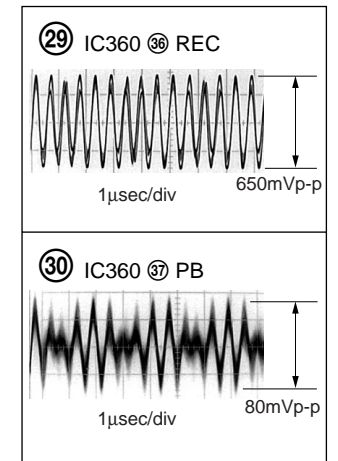

RP-235 BOARD

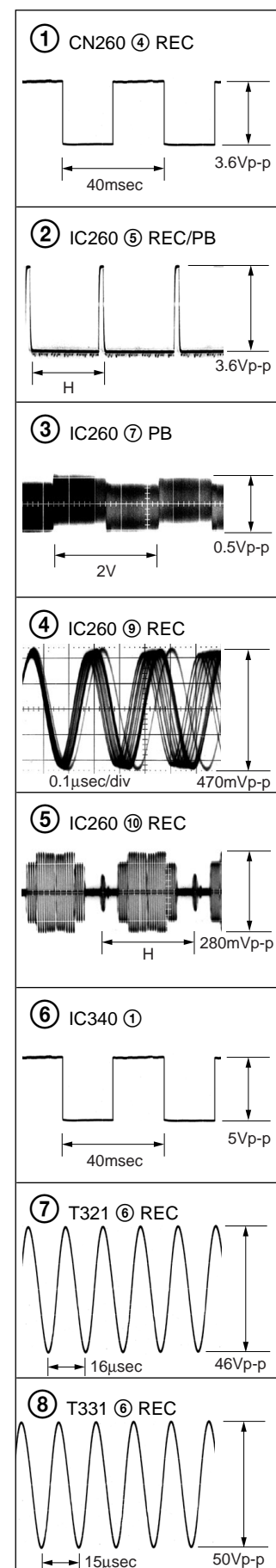

For schematic diagram
 • Refer to page 4-23 for waveforms.

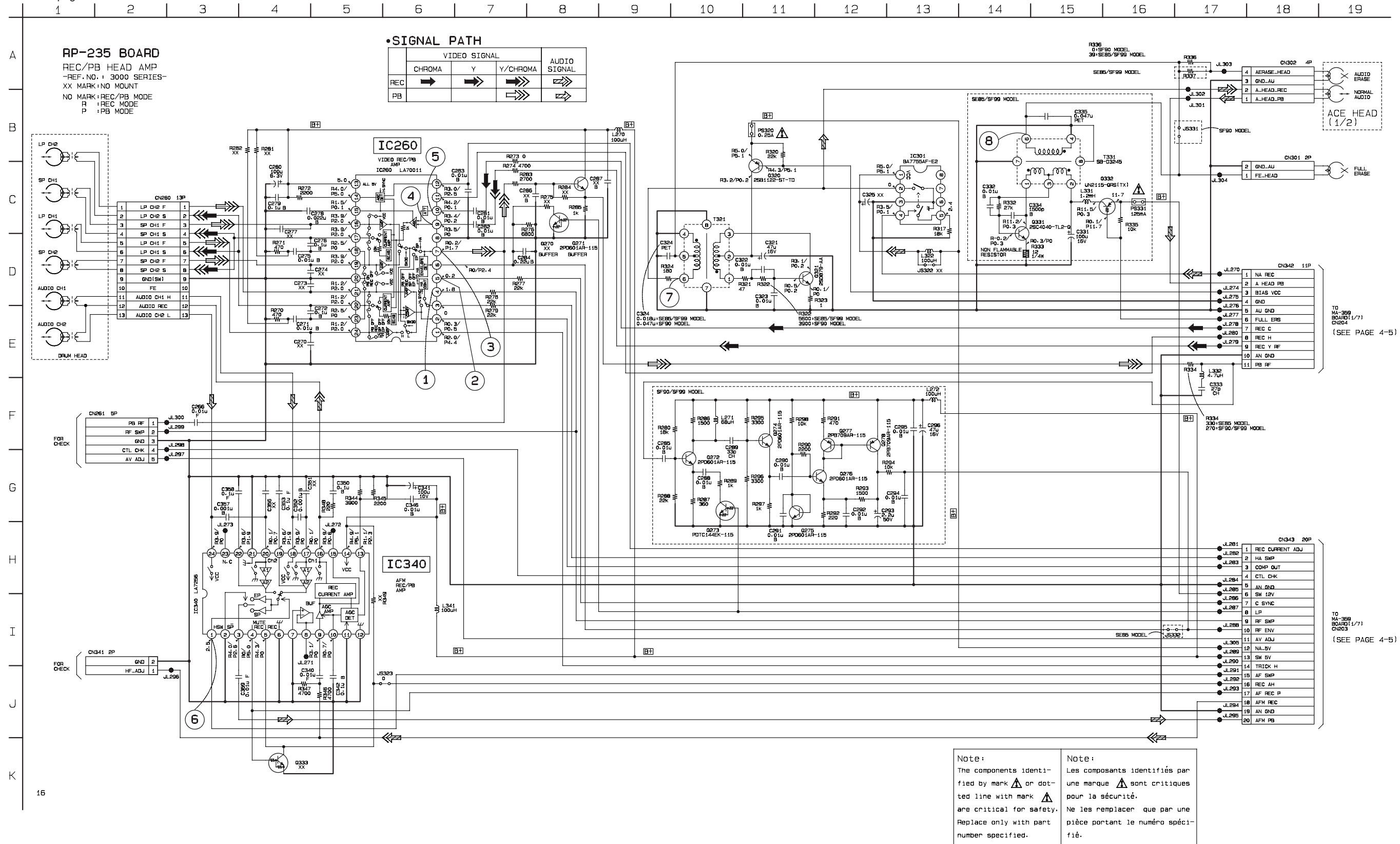

Note:
 The components identified by mark **▲** or dotted line with mark **▲** are critical for safety. Replace only with part number specified.

Note:
 Les composants identifiés par une marque **▲** sont critiques pour la sécurité. Ne les remplacer que par une pièce portant le numéro spécifié.

JK-171 (LINE 2 IN) PRINTED WIRING BOARD

— Ref. No. JK-171 Board: 3,000 Series —

JK-171 BOARD (SIDE B)

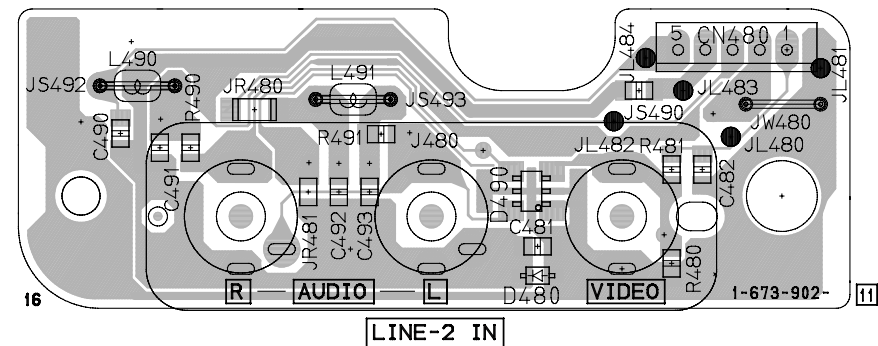

For printed wiring boards

There are few cases that the part printed on this diagram isn't mounted in this model.

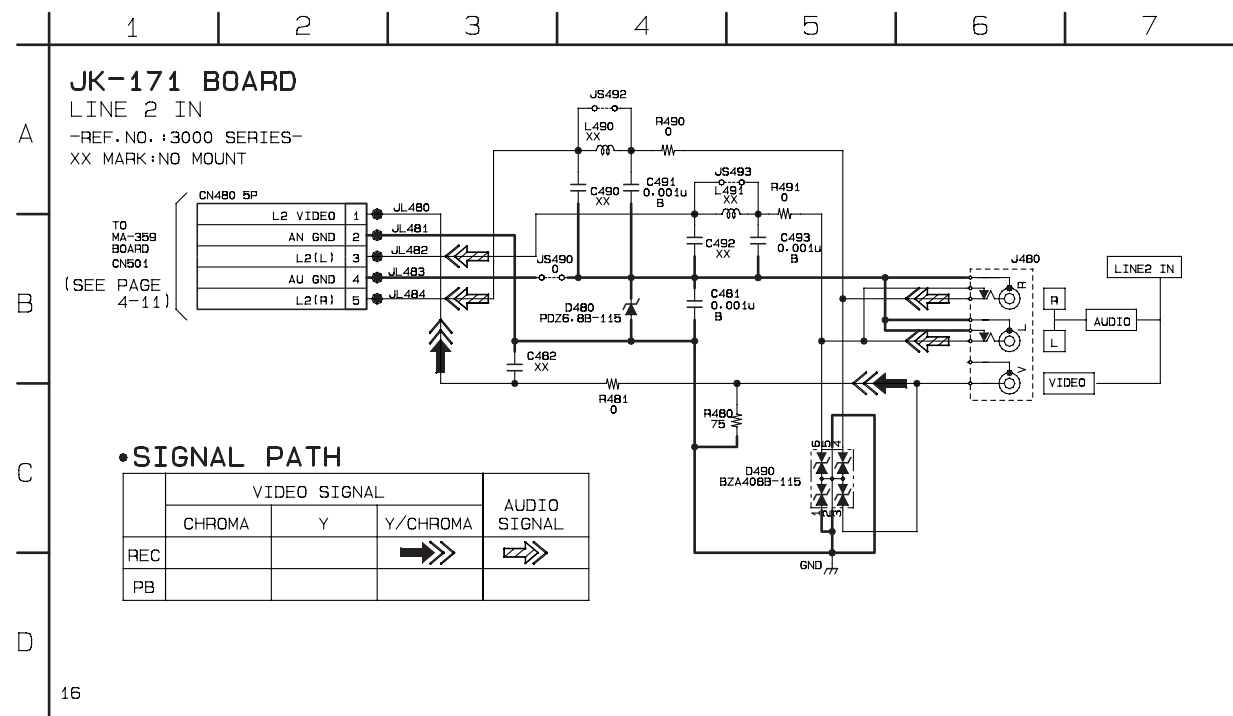
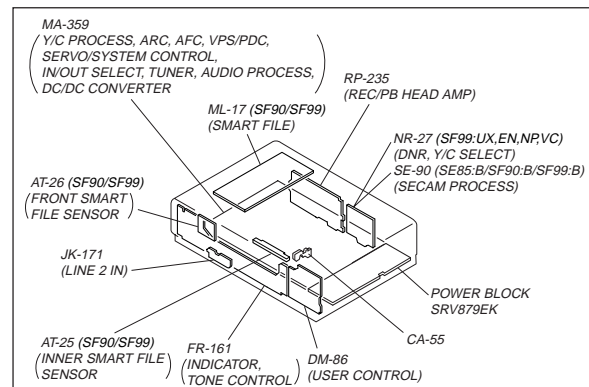

SE-90 (SECAM CHROMA PROCESS) PRINTED WIRING BOARD

— Ref. No. SE-90 Board; 3,000 Series —

SE-90 BOARD (SIDE B)

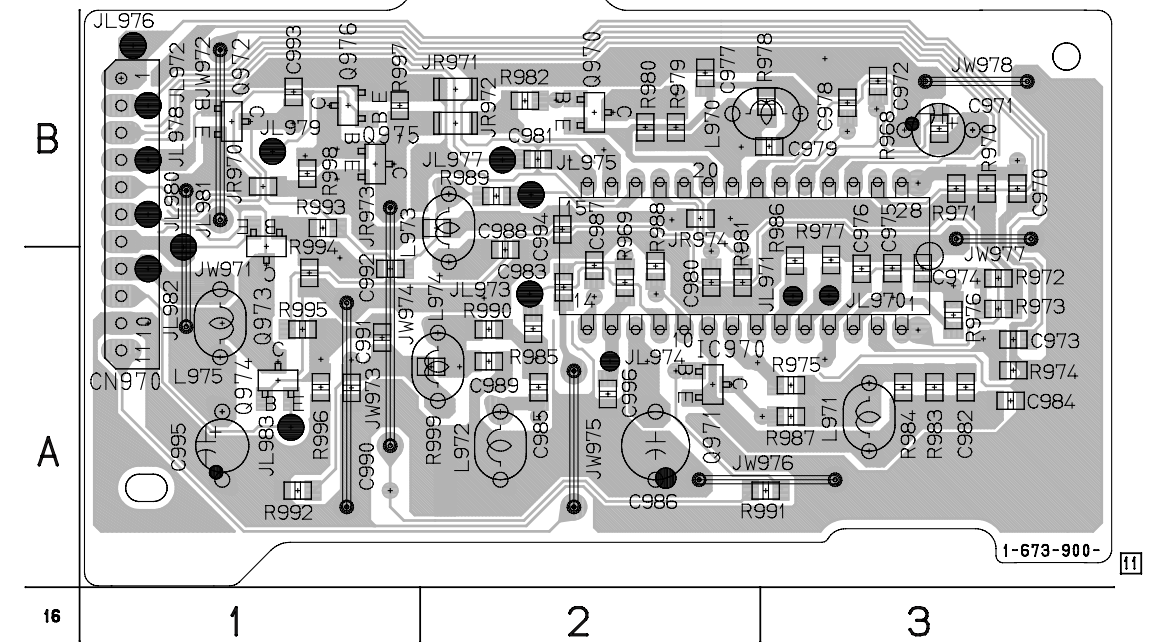

For printed wiring boards

There are few cases that the part printed on this diagram isn't mounted in this model.

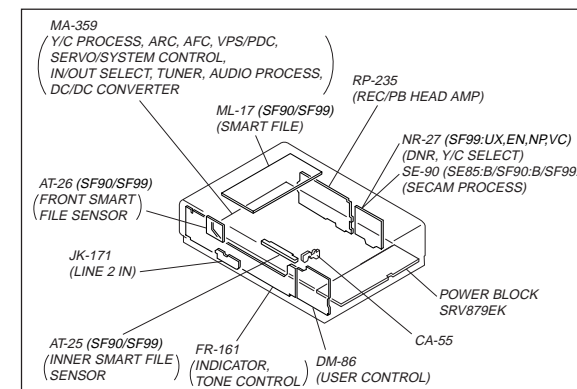

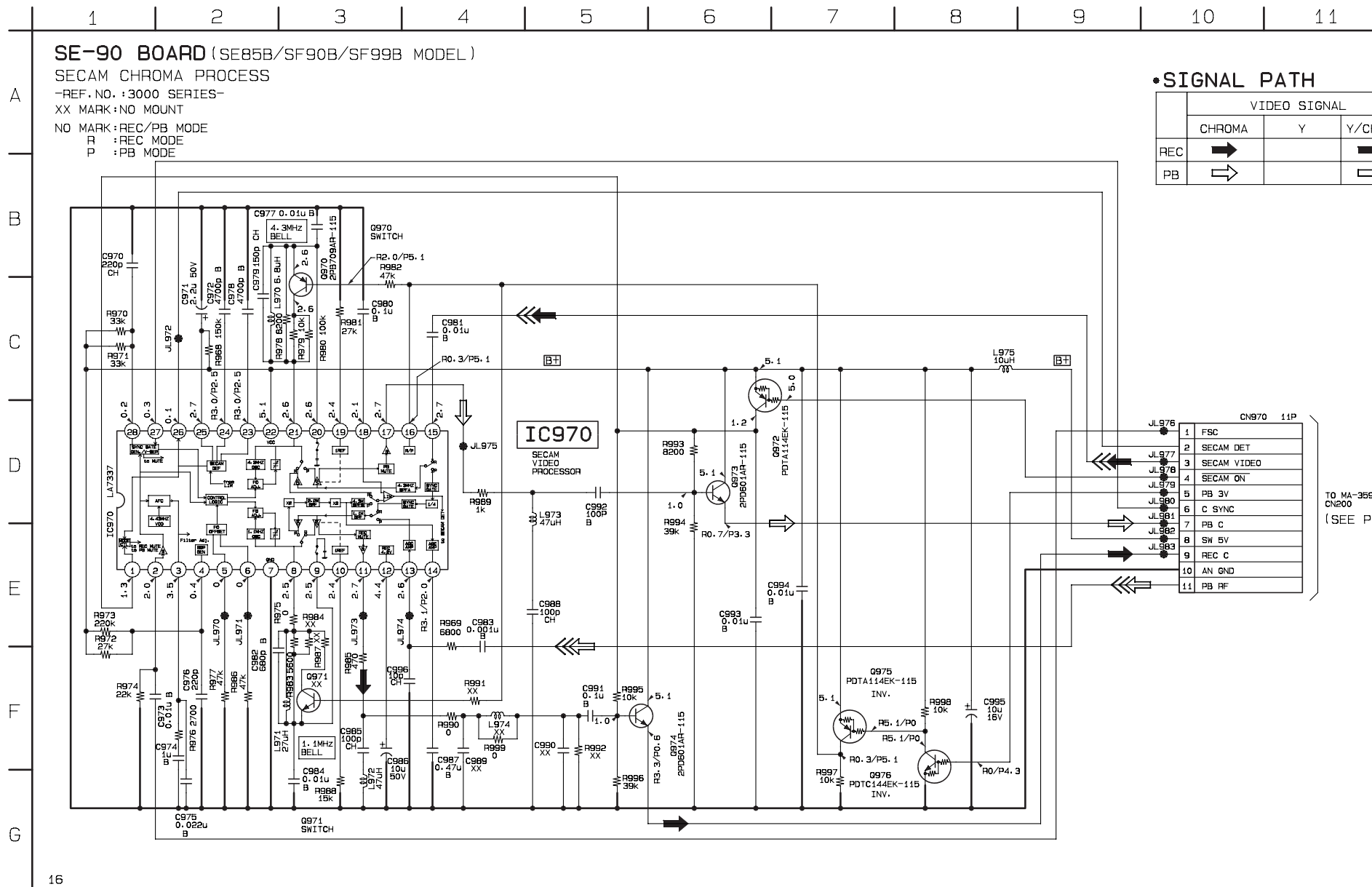

16

NR-27 (DNR, Y/C SELECT) PRINTED WIRING BOARD

— Ref. No. NR-27 Board; 2,000 Series —

NR-27 BOARD (SIDE B)

NR-27 BOARD

- CN001 B-1
- IC001 B-1
- IC002 C-1
- IC003 C-3
- IC004 C-2
- Q001 A-2
- Q002 A-2
- Q003 A-2
- Q004 A-2
- Q005 A-2
- Q006 A-1
- Q008 A-3
- Q009 A-1
- Q010 A-1
- Q011 A-3
- Q012 A-1
- Q013 A-1
- R021 A-3
- R025 A-3
- R029 A-3

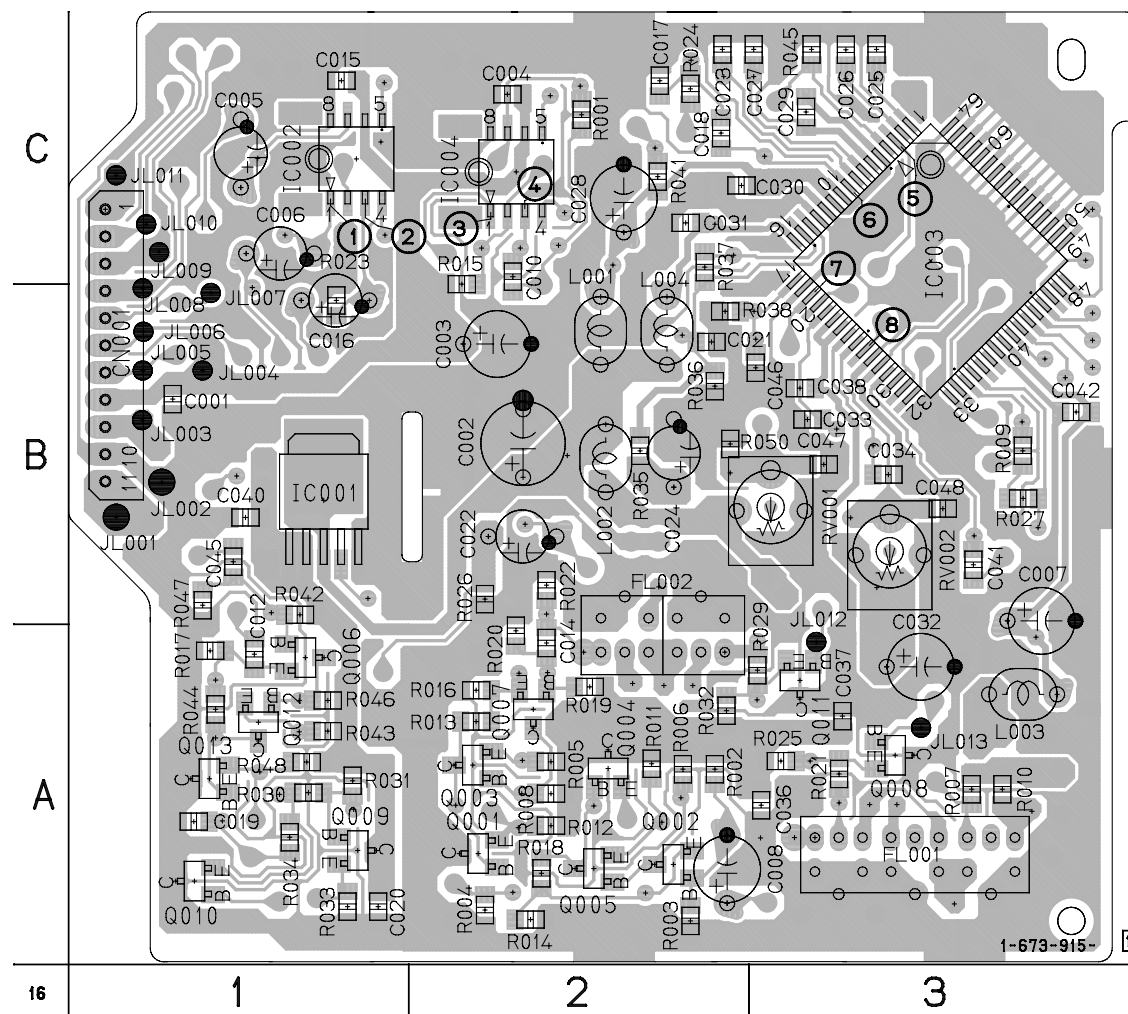

For printed wiring boards

There are few cases that the part printed on this diagram isn't mounted in this model.

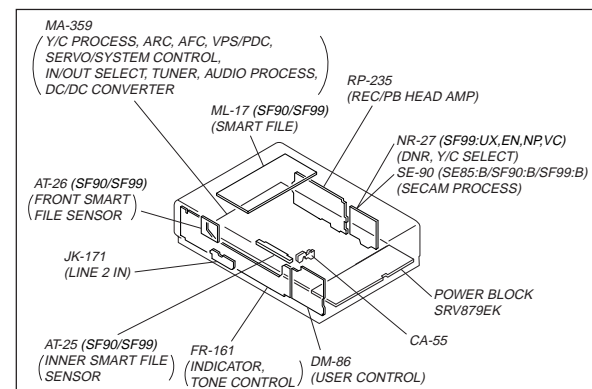

NR-27 BOARD

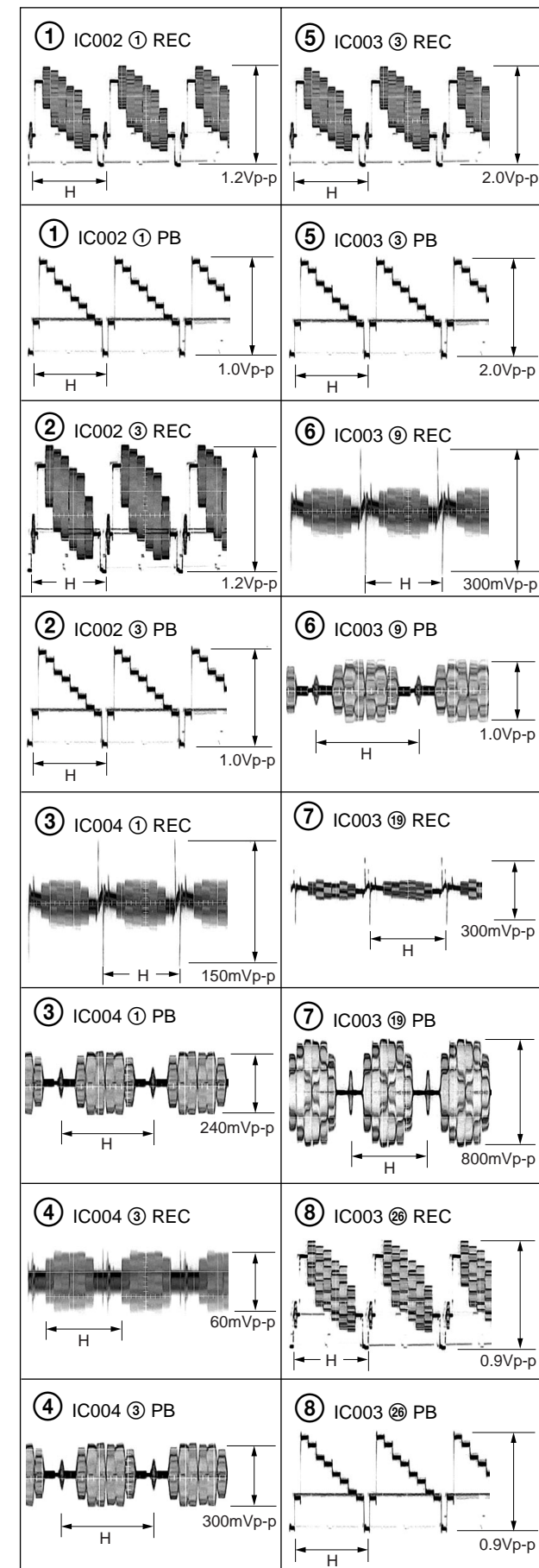

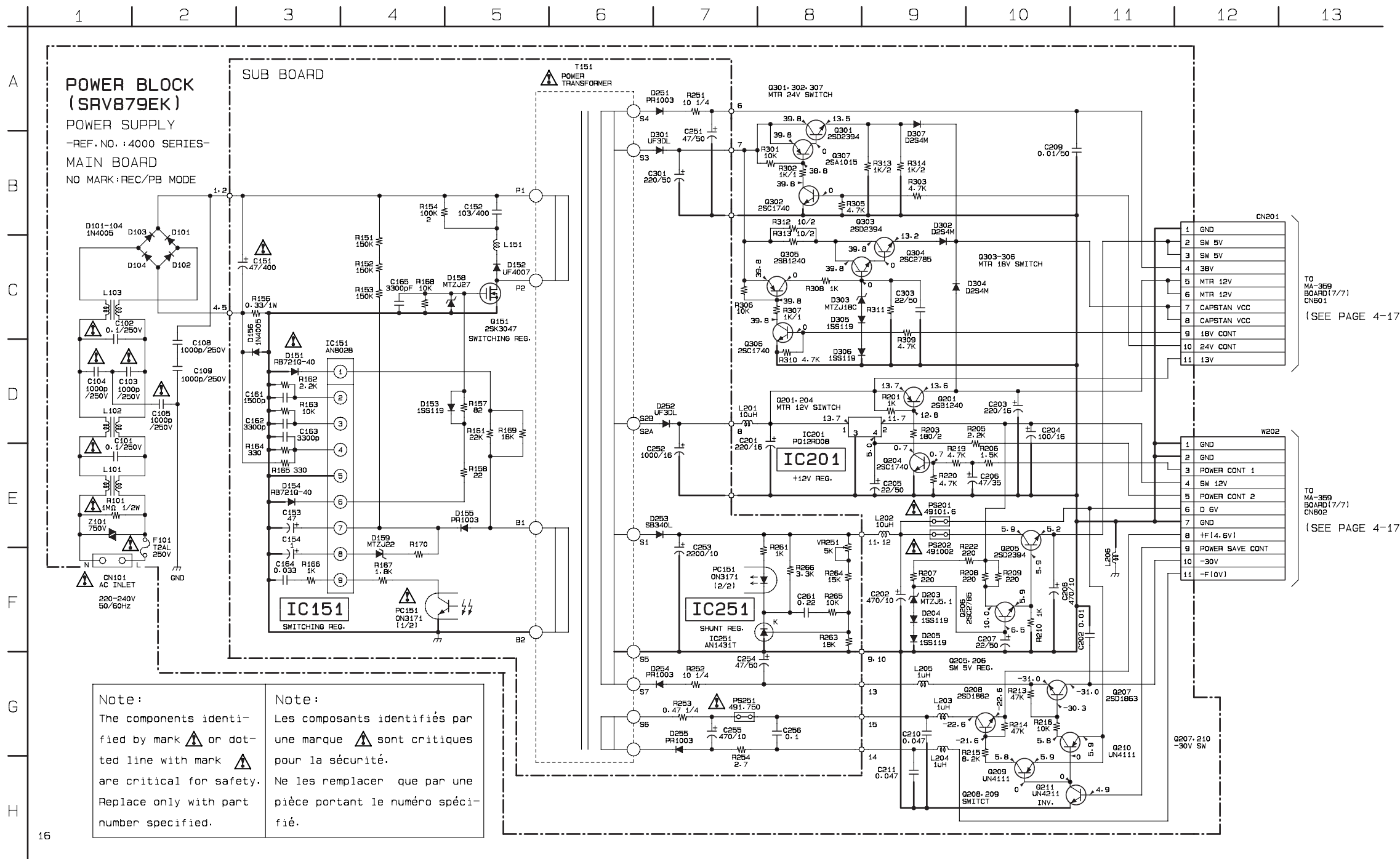

16

For schematic diagram
 • Refer to page 4-55 for waveforms.

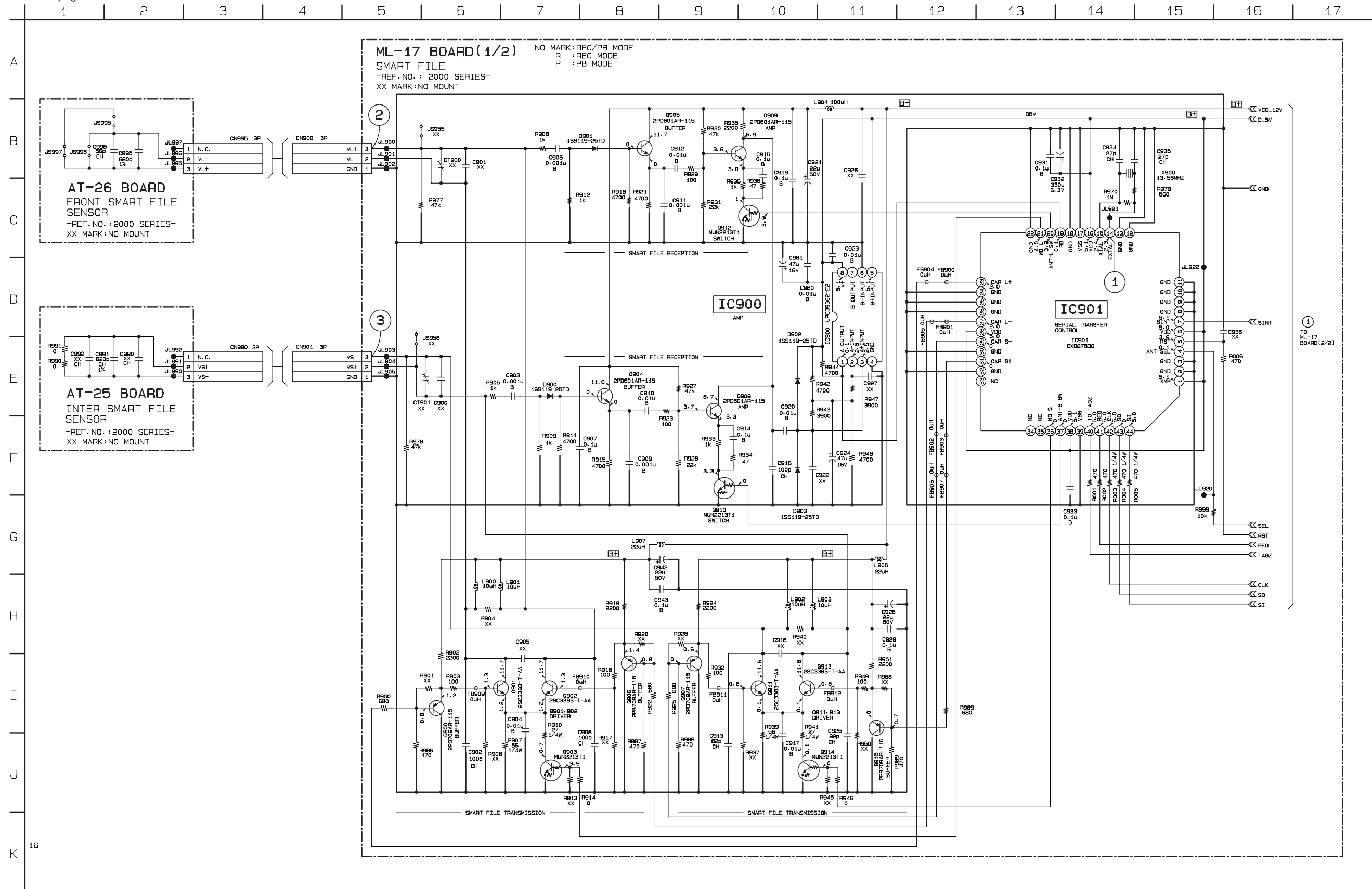

For schematic diagram
 • Refer to page 4-49 for printed wiring board.

1 2 3 4 5 6 7 8 9 10 11 12 13 14 15

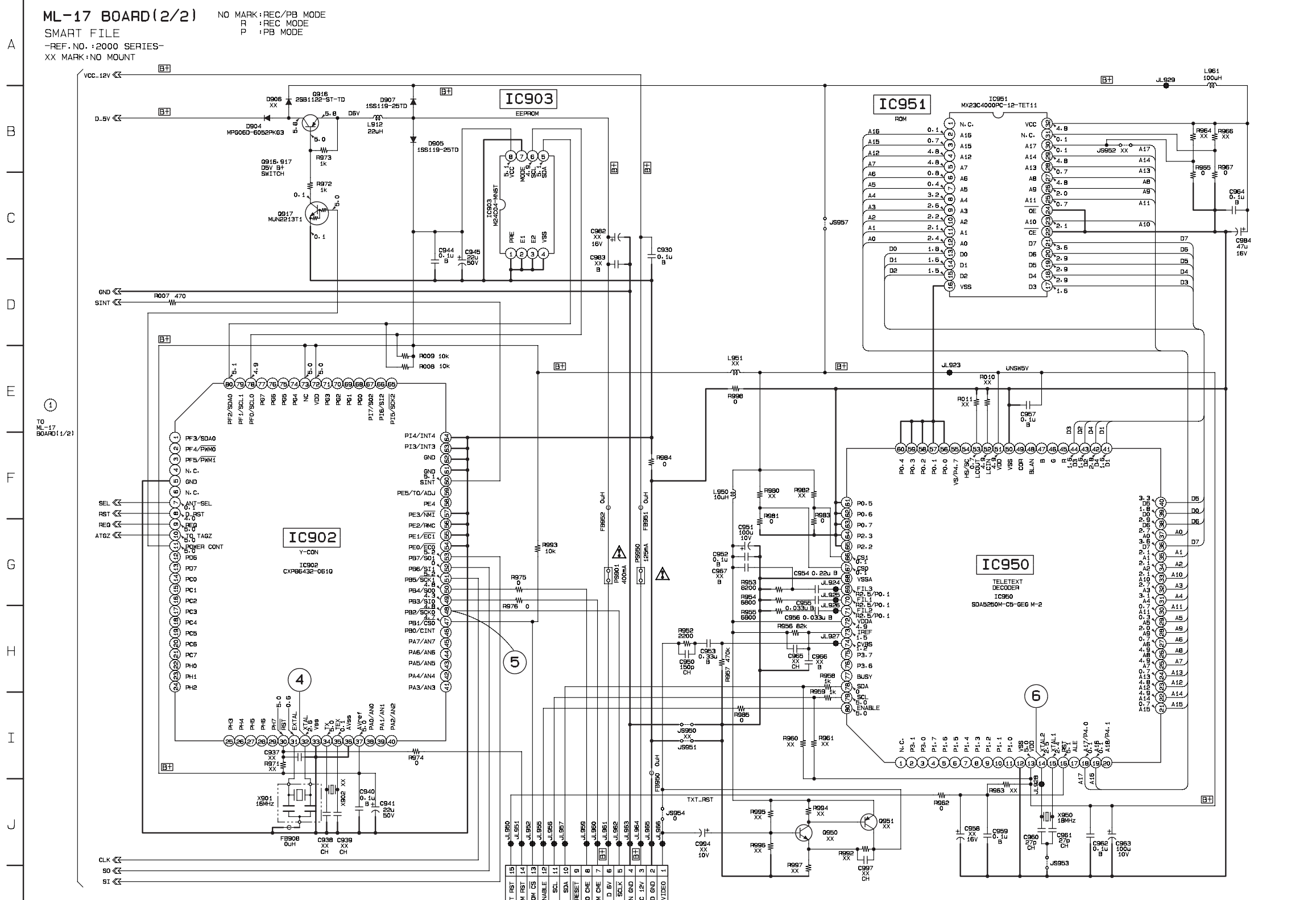

A
B
C
D
E
F
G
H
I
J
K
L

ML-17 BOARD(2/2)
 SMART FILE
 -REF. NO.: 2000 SERIES-
 XX MARK: NO MOUNT

NO MARK: REC/PB MODE
 R : REC MODE
 P : PB MODE

TO ML-17 BOARD(1/2)

TO MA-359 BOARD(3/7)
 CN166
 (SEE PAGE 4-9)

Note:
 The components identified by mark or dotted line with mark are critical for safety. Replace only with part number specified.

Note:
 Les composants identifiés par une marque sont critiques pour la sécurité. Ne les remplacer que par une pièce portant le numéro spécifié.

ML-17 BOARD (1/2)
REC/PB

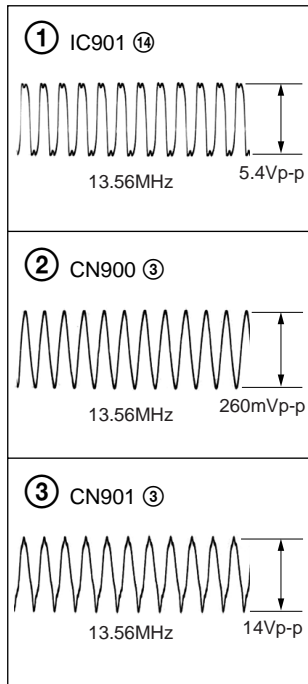

(2/2) REC/PB

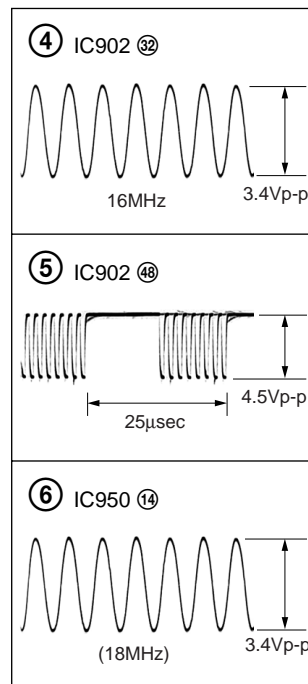

5-1. SYSTEM CONTROL — VIDEO BLOCK INTERFACE (MA-359 BOARD IC160)

Signal	Pin No.	I/O	STOP FF/REW	TAPE THREADING	TAPE UNTHREADING	PB	PB PAUSE	SLOW	x 2	CUE	REVIEW	REC	REC PAUSE
RF SWP	①	O	*1	*1	*1	*1	*1	*1	*1	*1	*1	*1	*1
QVD	④	O	L	L	L	*2	*3	*3	*2	*3	*3	L	L
V SYNC	②	I	*4	*5	*5	*5	*5	*5	*5	*5	*5	*5	*5
HA SWP	②	O	*1	*1	*1	*1	*1	*1	*1	*1	*1	*1	*1

- *1 Synchronized with drum rotation. 30Hz 50% duty cycle.
- *2 Normally "L", "H" when CTL signal is not generated.
- *3 V period "H" pulse.
- *4 Selected by REC mode. "H" in LP mode."
- *5 Composite sync signal (positive).

5-2. SYSTEM CONTROL — SERVO PERIPHERAL CIRCUIT INTERFACE (MA-359 BOARD IC160)

Signal	Pin No.	I/O	STOP	FF	REW	TAPE THREADING	TAPE UNTHREADING	PB	PB PAUSE	SLOW	CUE	x 2	REVIEW	REC	REC PAUSE
CAP STOP	③	O (O.D)	L	Hi-Z (O.D)	Hi-Z (O.D)	Hi-Z (O.D)	Hi-Z (O.D)	Hi-Z (O.D)	L	*3	Hi-Z (O.D)	Hi-Z (O.D)	Hi-Z (O.D)	Hi-Z (O.D)	Hi-Z (O.D)
STEP PLS	⑨	O	L	L	L	L	L	L	L	*2	L	L	L	L	L
DRM PG	⑤	I	*4	*1	*1	*5	*5	*1	*1	*1	*1	*1	*1	*1	*1
DRM FG	⑥	I	*4	*7	*7	*5	*5	*7	*7	*7	*7	*7	*7	*7	*7
CAP FG	⑦	I	H/L	*6	*6	*5	*5	*6	H/L	*2	*6	*6	*6	*6	H/L
CAP DA	⑧	O	*8	*8	*8	*8	*8	*9	*8	*8	*9	*8	*9	*9	*8
DRM DA	⑩	O	*10	*10	*10	*10	*10	*10	*10	*10	*10	*10	*10	*10	*10

- *1. 30Hz pulse (NTSC), 25Hz pulse (PAL).
- *2. Pulse at tape running.
- *3. Reverse logic pulse of STEP PLS.
- *4. "L" when drum rotation stops.
- *5. Unstable period pulse.
- *6. Pulse in period in proportional to tape speed.
- *7. 360Hz pulse (NTSC), 300Hz pulse (PAL).
- *8. Pulse at tape running.
- *9. Approx. 2 msec period "H" or "L" pulse.
- *10. Approx. 1.5 msec period "H" or "L" pulse.

5-3. SYSTEM CONTROL — MECHANISM INTERFACE (MA-359 BOARD IC160)

Signal	Pin No.	I/O	EJECTED	CASSETTE LOADING	CASSETTE UNLOADING	TAPE THREADING	TAPE UNTHREADING	STOP	FF	REW	PB	PB PAUSE	SLOW	x 2	CUE	REVIEW	REC	REC PAUSE
CAM2	⑨	HI-Z	L	H	L	H	L	*7	*7	*7	*7	*7	*7	*7	*7	*7	*7	*7
MODE 1 (*8)	⑳	I	H	L	L	*1	*1	H	H	H	H	H	H	H	H	L	H	H
MODE 2 (*8)	㉑	I	H	L	L	*1	*1	H	H	H	L	L	L	L	L	L	L	L
MODE 3 (*8)	㉒	I	L	L	L	*1	*1	H	L	L	L	L	L	L	L	H	L	L
MODE 4 (*8)	㉓	I	L	H	H	*1	*1	L	H	H	H	L	L	L	L	L	L	L
CIN (REC PRF)	㉔	I	H	*2	*2	*2	*2	*2	*2	*2	*2	*2	*2	*2	*2	*2	*2	*2
T REEL FG	㉕	I	H/L	H/L	H/L	H/L	H/L	H/L	*3	*3	*3	H/L	*3	*3	*3	*3	*3	H/L
S REEL FG	㉖	I	H/L	H/L	H/L	*3	*3	H/L	*3	*3	*3	H/L	*3	*3	*3	*3	*3	H/L
T/E LED	㉗	O (O.D.)	*4	*4	*4	*4	*4	*4	*4	*4	*4	*4	*4	*4	*4	*4	*4	*4
CAP STOP	㉘	O (O.D.)	L	L	L	H	H	L	H	H	H	L	*5	H	H	H	H	L
CAP RVS	㉙	O	H			L	H	H/L	L	H	L	L	L/*5	L	L	H	L	L
T SENS	㉚	I	*4	*4	*4	*6	*6	*6	*6	*6	*6	*6	*6	*6	*6	*6	*6	*6
S SENS	㉛	I	*4	*4	*4	*6	*6	*6	*6	*6	*6	*6	*6	*6	*6	*6	*6	*6

*1. Uncertainly.

*2. "L" when erasing protection tab is bent. "H" when not bent.

*3. Pause of period in proportion to reel rotating speed.

*4. Approx. 2 msec period "H" pulse.

*5. Pulse at tape running.

*6. Normally "L". 2 msec period "H" pulse when tape top or tape end is detected.

*7. When transition to UNLOADING direction : "L".

When transition to LOADING direction : "H".

When CAM MOTOR is stopped : Hi-Z.

*8. When RVS slow : Mode 1="L"

When RVS slow : Mode 2="L"

When RVS slow : Mode 3="H"

When RVS slow : Mode 4="L"

5-4. SYSTEM CONTROL — SYSTEM CONTROL PERIPHERAL CIRCUIT INTERFACE (MA-359 BOARD IC160)

Signal	Pin No.	I/O	I/O Level
ASURA RESET	㉜	I	Normally "H", "L" when service interruption is detected or restored.
ASURA CS	㉝	I	Chip select signal from timer microprocessor. V period "L" pulse.
S IN 0	㉞	I	Serial communication data from timer microprocessor. V period "L" pulse.
S OUT 0	㉟	O	Serial communication data to timer microprocessor. V period "L" pulse.
S CLK	㊱	I	Serial communication clock with timer microprocessor. V period "L" pulse.

5-5. SYSTEM CONTROL — AUDIO BLOCK INTERFACE (MA-359 BOARD IC160)

Signal	Pin No.	I/O	STOP/FF/ REW	TAPE LOADING	TAPE UNLOADING	PB	PB PAUSE	SLOW	x 2	CUE	REVIEW	REC	REC PAUSE
AF ENV	㊲	I	AF RF envelope signal input terminal for automatic tracking.										
A MUTE	㊳	O (O.D.)	L	L	L	*1	H	H	H	H	H	L	L
AF REC P	㊴	O	L	L	L	L	L	L	L	L	L	H	L
AF SWP	㊵	O	*1	*1	*1	*1	*1	*1	*1	*1	*1	*1	*1
FULL ERS	㊶	O (O.D.)	H	H	H	H	H	H	H	H	H	L	H

*1. 30 Hz 50 % duty pulse approx. 5 msec delayed from RF SW P.

5-6. SERVO/SYSTEM CONTROL MICROPROCESSOR PIN FUNCTIONS (MA-359 BOARD IC160)

Pin No.	Pin Name	I/O	Function
1	RF SWP	O	RF switching pulse output.
2	AF REC \bar{P}	O	“H” when HiFi audio REC.
3	N.C	O	Not used.
4	QVD	O	Quasi VD pulse output.
5	AUTO PRESET	O	“H” during auto preset.
6	FE ON	O	Flying erase ON/OFF.
7	SW1	O	BG/L control signal
8	N.C		Not used.
9	CAM 2	I	Cam motor control.
10	N.C		Not used.
11	TA MUTE	O	Tuner audio mute. H: Mute
12	SECAM DET	I	Not used.
13	N.C	I	Not used.
14	SECAM MIX		Not used.
15	CIN (REC PRF)	I	Erasing protection tab, cassette in detection signal input.
16	AV CONT	O	Not used.
17	$\overline{\text{SECAM ON}}$		
18	MODE 4	I	Cam encoder signal input.
19	MODE 3	I	Cam encoder signal input.
20	MODE 2	I	Cam encoder signal input.
21	MODE 1	I	Cam encoder signal input.
22	ENV SW	I	Video envelope mode detect signal (SP or EP)
23	S IN 0	I	Serial communication signal.
24	S OUT 0	O	Serial communication signal.
25	\bar{S} CLK	I	Serial communication signal.
26	$\overline{\text{ASURA CS}}$	I	Servo/system control microcomputer chip select signal.
27	SRVO	O	Not used.
28	CAP TRQ PWM	O	PWM output for capstan torque control.
29	C + DET		Not used.
30	$\overline{\text{CAP RVS}}$	O	Capstan reverse control “L” when reverse.
31	A MUTE	O	“H” when audio mute.
32	T/E LED	O	Tape top /end sensors driver.
33	$\overline{\text{CAP STOP}}$	O	Capstan stop signal output.
34	$\overline{\text{FULL ERS}}$	O	Full erase control.
35	N.C		Not used.
36	SDA 0	I/O	Serial communication data.
37	N.C		Not used.
38	SCL 0	I/O	Serial communication clock.
39	MP	—	Ground.
40	$\overline{\text{ASURA RESET}}$	I	System reset signal.
41	V SS	—	Ground.
42	XTAL	O	System clock (16 MHz).
43	EXTAL	I	System clock (16 MHz).
44	N.C	—	Not used.
45	DRM PG	I	Drum PG input.
46	DRM FG	I	Drum FG input.
47	CAP FG	I	Capstan FG input.
48	$\overline{\text{DNR RST}}$	—	NICOL control signal out.
49	FRONT SEL	—	Cable box control signal out.
50	I CONT	—	Forced mono.

Pin No.	Pin Name	I/O	Function
51	SW2	O	Not used.
52	AVSS	—	Ground.
53	AVref	I	D5V
54	AVDD	I	D5V
55	NTPB SW	I	Ground.
56	AV ADJ	I	Adjustment mode.
57	$\overline{\text{FOLLW TV}}$	—	Ground.
58	N.C	—	Ground.
59	AF ENV	I	HiFi audio playback signal envelope.
60	RF ENV	I	Video playback signal envelope.
61	T SENS	I	Take-up end sensor.
62	S SENS	I	Supply end sensor.
63	N.C	I	Not used.
64	AMP VSS	—	Ground.
65	CTL HEAD (-)	I/O	CTL signal I/O.
66	CTL HEAD (+)	I/O	CTL signal I/O.
67	HEADL (+)	O	CTL signal.
68	HEADL (-)	O	CTL signal.
69	CTL F AMP (+)	I	CTL first AMP input.
70	CTL F AMP (-)	I	CTL first AMP input.
71	CTL GND	O	Ground.
72	CTL S AMPI	I	CTL second AMP input.
73	CTL F AMPO	O	CTL first AMP output.
74	AMP VDD	I	5 V.
75	CTL OUT	O	Control signal output for check pin.
76	S REEL FG	I	Supply reel FG input.
77	T REEL FG	I	Take-up reel FG input.
78	CAP DA	O	Capstan error D/A output.
79	DRM DA	O	Drum error D/A output.
80	N.C		UNSW 5 V.
81	N.C	—	Ground.
82	VSYNC	I	Composite sync signal input.
83	N.C		Not used.
84	24 V_CONT	O	24 V control, when the high speed mode.
85	18 V_CONT	O	18 V control, when the high speed mode.
86	N.C		Not used.
87	N.C		Not used.
88	VSS	—	Ground.
89	VDD	I	D5V
90	5V	I	D5V
91	N.C	O	Not used.
92	FAST SEARCH	O	Switching signal for capacitor on CTL(X).
93	HA SWP	O	Head AMP SWP.
94	POWER SAVE CONT 1	O	Not used.
95	POWER SAVE C+	O	Not used.
96	MOD CONT	O	Tuner modulation out control signal.
97	$\overline{\text{SP/LP}}$	O	Tape speed mode control signal “L” when SP mode.
98	TV/VTR	O	Not used.
99	STEP PLS	O	Step pulse “H” when capstan step driving.
100	AF SWP	O	AF switching pulse output.

5-7. TUNER/TIMER MODE CONTROL PIN FUNCTION (FR-161 BOARD IC180)

Pin No.	Pin Name	I/O	Function
1	TXT RST	O	Teletext IC (ML Board IC950) Reset signal
2	NC	—	
3	LANC IN (SENER)	I	Lanc Input
4	LANC OUT (SENER)	O	Lanc Output
5	NC	—	
6	SIRCS IN	I	Remote control Input.
7	EED DATA	I/O	I2C bus interface Data Input/Output
8	EED SCL	I/O	I2C bus interface Clock Input/Output
9	SDA	I/O	I2C bus interface Data Input/Output
10	SCL	I/O	I2C bus interface Clock Input/Output
11	FDP CS	O	FLD Driver Chip Select
12	NC	—	
13	X-UCOM CS	O	ML IC Chip Select (ML Board IC902)
14	NC	—	
15	VSS	—	GND
16	TU ENABLE	O	Tuner Chip Select
17	PLL CLK	O	Tuner PLL Clock
18	PLL DATA	O	Tuner PLL Data
19	OSD CS	O	OSD IC (MA359 IC660) Chip Select
20	NC	—	
21	ASURA RESET	O	S/S micom (MA359 board IC160) reset signal
22	ASURA CS	O	S/S micom (MA359 board IC160) Chip Select signal
23	POWER CONT1	O	Main Power supply control signal
24	POWER CONT2	O	Secondary Power supply control signal
25	NC	—	Together with 28, 30 & 31
26	ML ENABLE	O	ML board IC950 Enable signal
27	OPTION2	I	ML board IC950 Busy signal
28	NC	—	Together with 25, 30 & 31
29	OPTION3	—	Not used ?
30	NC	—	
31	NC	—	Together with 28 & 25
32	Not used	—	
33	Not used	—	Positive supply Voltage
34	Not used	—	
35	SI (TO CME)	I	Serial Data Input
36	SO (FROM CME)	O	Serial Data Output
37	SCLK	I/O	Serial Clock Input/Output
38	NC	—	
39	NC	—	
40	RST	I	System Reset
41	VSS	—	GND
42	XTAL	O	Internal Oscillator output for 20 MHz crystal
43	EXTAL	I	Internal Oscillator 20 MHz crystal input
44	VDD	—	Positive supply Voltage
45	NC	—	
46	NC	—	Together with 49 ~ 52
47	OSD SO (FROM CME)	O	Serial Data Output
48	OSD SCLK	O	Serial Clock Input/Output

Pin No.	Pin Name	I/O	Function
49	NC	—	
50	NC	—	
51	NC	—	Together with 45 & 46
52	NC	—	
53	VDD	—	Positive supply Voltage
54	TEX	I	Internal Oscillator 32 kHz crystal input
55	TX	O	Internal Oscillator output for 32 kHz crystal
56	VSS	—	GND
57	AV LINK OUT	O	AV LINK output
58	SIRCS OUT	O	Remote control output
59	NC	—	
60	NC	—	Together
61	NC	—	
62	BUZZER	O	Buzzer Output/Clock Crystal frequency division output
63	POWER FAIL	I	Power Voltage drop Detection pin
64	Not used	—	Positive supply Voltage
65	Not used	—	Positive supply Voltage
66	CGV	I	Vertical Synchro detection
67	PDC DAV	I	VPS/PDC Acknowledge signal
68	Not used	—	Positive supply Voltage
69	AV LINK IN	I	AV LINK input
70	Not used	—	Positive supply Voltage
71	Not used	—	Positive supply Voltage
72	A/D0	I	Key Pad Reading
73	A/D1	I	Key Pad Reading
74	A/D2	I	Key Pad Reading
75	A/D3	I	Key Pad Reading
76	A VSS	—	GND
77	A VREF0	—	Positive supply Voltage
78	A VREF1	—	Positive supply Voltage
79	A VDD	—	Positive supply Voltage
80	A/D4	I	Key Pad Reading
81	A/D5	I	Key Pad Reading
82	A/D6	—	
83	Not used	—	Together
84	DMS1	I	
85	DMS2	I	
86	AFT	I	Ground Wave tuner AFT detection
87	HDET	I	HDET signal input
88	VDD	—	Positive supply Voltage
89	VDD	—	Positive supply Voltage
90	VSS	—	GND
91	NC	—	
92	NC	—	
93	NC	—	
94	NC	—	
95	NC	—	Together
96	NC	—	
97	NC	—	
98	NC	—	
99	EED MODE	O	EED Mode control
100	X-UCOM RST	O	X-UCOM reset signal (IC902 ML Board)

SECTION 6 ADJUSTMENTS

6-1. MECHANICAL ADJUSTMENT

For the mechanical adjustments, please refer to the "VHS MECHANICAL ADJUSTMENT MANUAL VI (S MECHANISM)" (9-921-647-13)

6-2. ELECTRICAL ADJUSTMENT

2-1. PREPARATION BEFORE ADJUSTMENT

2-1-1. Equipment Required

The measuring instruments used for this alignment include:

- 1) Monitor TV
- 2) Oscilloscope, dual-trace, bandwidth above 30 MHz with delay mode (Unless specified otherwise, use a 10 : 1 probe.)
- 3) Frequency counter
- 4) PAL pattern generator
- 5) Remote commander
- 6) Digital voltmeter
- 7) Audio generator
- 8) Audio level meter
- 9) Audio attenuator
- 10) Alignment tape
KRV-51NP (PAL) Part No.: 8-192-955-57

2-1-2. Equipment Connection

Unless specified otherwise, connect the measuring instrument as shown in the following diagram.

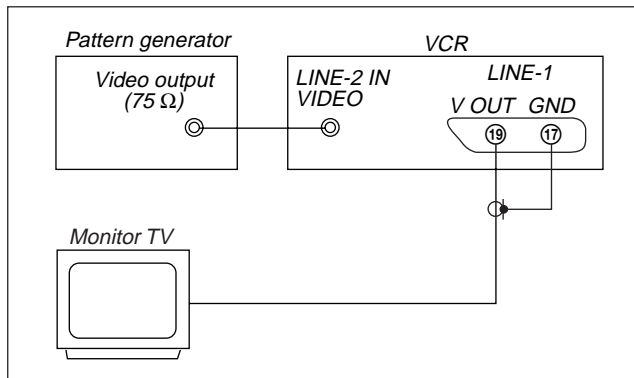

Fig. 6-2-1.

2-1-3. Setup for adjustment

Because the video signal obtained from the pattern generator is used as the adjustment signal for adjustments, the video output signal must satisfy the given specification.

Connect the oscilloscope to VIDEO LINE-2 IN terminal, and check that the amplitude of sync signal is approximately 0.3V, the amplitude of the video section is approximately 0.7V and the amplitude of burst signal is approximately 0.3V. And check that the level ratio of the burst signal to "red" signal is 0.30 : 0.66.

The video signal used for adjustments is shown in Fig. 6-2-2.

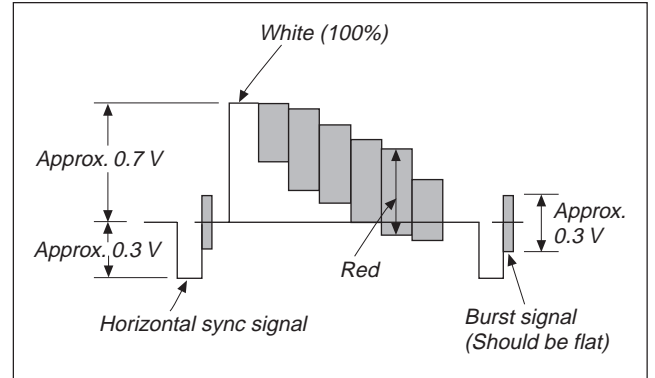

Fig. 6-2-2. Color Bar Signal of Pattern Generator

2-1-4. Alignment Tape

• Contents of KRV-51NP

	Mode	Period	Video signal	Audio signal	
				Hi-Fi	Normal
1	SP	7 minutes	Color bar	400Hz (L/R)	400Hz
2		3 minutes	Monoscope		
3	LP	7 minutes	Color bar		
4		3 minutes	Monoscope		

2-1-5. Input/Output Levels and impedance

Video input: LINE-1 / LINE-3 IN(*1) / LINE-4 IN(*2)

EURO AV connector

Input signal: 1Vp-p, 75 ohms, unbalanced, sync negative

LINE-2 IN / LINE-3 IN(*2), Phono jack

Input signal: 1Vp-p, 75 ohms, unbalanced, sync negative

Video output: LINE-1, EURO AV connector

Output signal: 1Vp-p, 75 ohms, unbalanced, sync negative

LINE-2 OUT(*2), Phono jack

Output signal: 1Vp-p, 75 ohms, unbalanced, sync negative

Audio input: LINE-1 / LINE-3 IN(*1) / LINE-4 IN(*2)

EURO AV connector

Input level: -6.3dBs

Input impedance: more than 47 kilohms

LINE-2 IN/ LINE-3 IN(*2), Phono jack

Input level: -7.5dBs

Input impedance: more than 47 kilohms

(0dBs=0.775Vrms)

Audio output: LINE-1, EURO AV connector

Output level: -6.3dBs at load impedance 47 kilohms

Output impedance: less than 10 kilohms

LINE-2 OUT(*2), Phono jack

Output level: -7.5dBs at load impedance 47 kilohms

Output impedance: less than 10 kilohms

*1 : SLV-SE85/SF90 model only

*2 : SLV-SF99 model only

2-1-6. Adjustment Sequence

The adjustments should be performed in the following sequence.

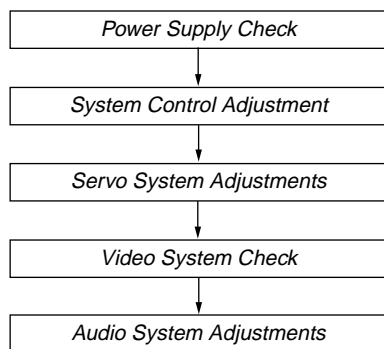

2-2. POWER SUPPLY CHECK

2-2-1. Power Supply Voltage Check (MA-359 board)

Mode	E-E
Measuring instrument	Digital voltmeter
38V check	
Measurement point	CN601 pin ④
Specified value	39 ± 3Vdc
13V check	
Measurement point	CN601 pin ⑩
Specified value	13.55 ± 0.45Vdc
MTR12V check	
Measurement point	CN601 pin ⑤ or ⑥
Specified value	13.5 ^{+0.6} _{-0.4} Vdc
CAPSTAN VCC check	
Measurement point	CN601 pin ⑦ or ⑧
Specified value	13.5 ± 0.5Vdc
SW12V check	
Measurement point	CN602 pin ④
Specified value	12.0 ± 0.3Vdc
D6V check	
Measurement point	CN602 pin ⑥
Specified value	5.9 ± 0.15Vdc
SW5V check	
Measurement point	CN601 pin ② or ③
Specified value	5.15 ± 0.15 Vdc
-30V check	
Measurement point	CN602 pin ⑩
Specified value	-29 ± 3Vdc
+F, -F check	
Measurement point	+ probe: CN602 pin ⑧ - probe: CN602 pin ⑪
Specified value	4.6 ± 0.5Vdc

[Check Method]

- 1) Check that each power supply voltage satisfies the specified value.

2-3. SYSTEM CONTROL SYSTEM ADJUSTMENT

2-3-1. Clock Adjustment (FR-161 board)

[Adjustment Purpose]

To adjust the precision of the clock. If this specification is not satisfied, the clock will lose or will gain time.

Mode	E-E
Signal	Arbitrary
Measurement Point	IC180 Pin ② (BUZZER)
Measuring Instrument	Frequency counter
Adjusting element	CT180
Specified Value	$f = 8.192000$ to 8.1920325kHz

[Adjusting method]

- 1) Connect JL237 (Connecting point of R416 (2.2k Ω) and R412 (2.2k Ω)) and GND with a jumper wire.
- 2) Adjust the BUZZER frequency (f) to the specified value with CT180.
- 3) Remove the jumper wire.

2-4. SERVO SYSTEM ADJUSTMENT

2-4-1. RF Switching Position Adjustment (MA-359 board)

[Adjustment Purpose]

To adjust the link of the A-ch and B-ch of the tape playback outputs. To make the unit compatible with other tapes and units. If this specification is not satisfied, the link will appear on the screen and the screen will be disrupted, etc.

Mode	Playback
Signal	Alignment tape: SP mode color bar portion

[Adjustment method]

- 1) Connect RP-235 board CN261 pin ⑤ (AV ADJ) and GND with a jumper wire.
- 2) Check that "AP" indicator on the display window turns on.
- 3) Remove the jumper wire.
- 4) Press EJECT button. (RF switching position adjustment is performed automatically.)
- 5) Perform "Hi-Fi Switching Position Adjustment".

2-4-2. Hi-Fi Switching Position Adjustment (MA-359 board)

[Adjustment Purpose]

To adjust the link of the A-ch and B-ch of the tape playback outputs. To make the unit compatible with other tapes and units. If this specification is not satisfied, the switching noise will be heard, etc.

Mode	Playback
Signal	Alignment tape: SP mode color bar portion
Measurement Point	CH1: RP-235 board CN341 pin ① (HF ADJ) CH2: RP-235 board CN261 pin ② (RF SWP)
Measuring Instrument	Oscilloscope
Specified Value	A = minimum

Note: Perform "RF Switching Position Adjustment" before this adjustment.

[Adjustment method]

- 1) Connect RP-235 board CN261 pin ⑤ (AV ADJ) and GND with a jumper wire.
- 2) Check that "AP" indicator on the display window turns on.
- 3) Remove the jumper wire.
- 4) Press REC button.
- 5) Check that "AH" indicator on the display window turns on.
- 6) Press PROGRAM+ and PROGRAM- buttons and minimize the part A of PB AF RF signal.
- 7) Press PAUSE button.
- 8) Check that the "AH" indicator turns off.

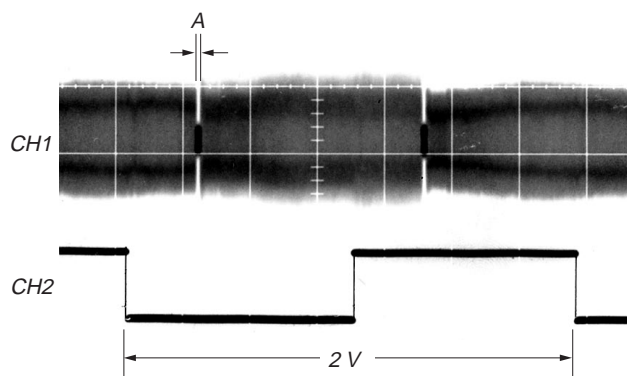

Fig. 6-2-3.

2-5. VIDEO SYSTEM CHECK

2-5-1. Playback Level Check (MA-359 board)

[Adjustment purpose]

Confirm that the playback video signal level is within the specification.

Mode	Playback
Signal	Alignment tape: SP mode color bar portion
Measurement Point	CN200 ⑪ pin (EEV PB) (Note1) JW234 (IC001 ⑱ pin : ARCVY) (Note2)
Measuring Instrument	Oscilloscope
Specified Value	A=2.00 ± 0.18V

Note 1: For SLV-SF99 model. (Except B model)

Note 2: For SLV-SE85/SF90 or B model.

[Check method]

- 1) Check that the video signal level (A) satisfies the specified value.

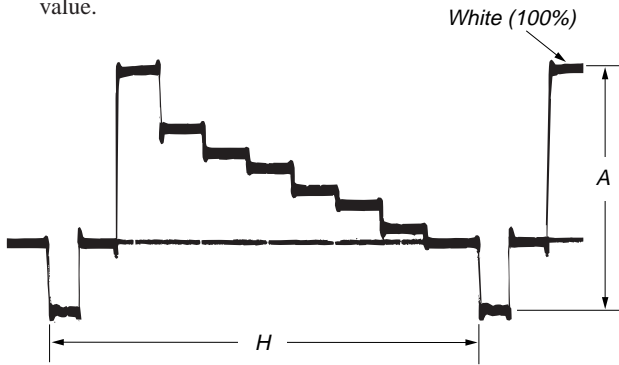

Fig. 6-2-4.

2-5-2. Sync AGC Check (MA-359 board)

[Adjustment purpose]

Confirm that the E-E video output level is within the specification.

Mode	E-E
Signal	Color bar
Measurement Point	CN200 ⑪ pin (EEV PB) (Note1) JW234 (IC001 ⑱ pin : ARCVY) (Note2)
Measuring Instrument	Oscilloscope
Specified Value	A=2.0 ± 0.1V

Note 1: For SLV-SF99 model. (Except B model)

Note 2: For SLV-SE85/SF90 or B model.

Switch setting:

INPUT SELECT L2

[Check method]

- 1) Input a color bar signal to VIDEO LINE 2 terminal.
- 2) Check that the video signal level (A) satisfies the specified value.

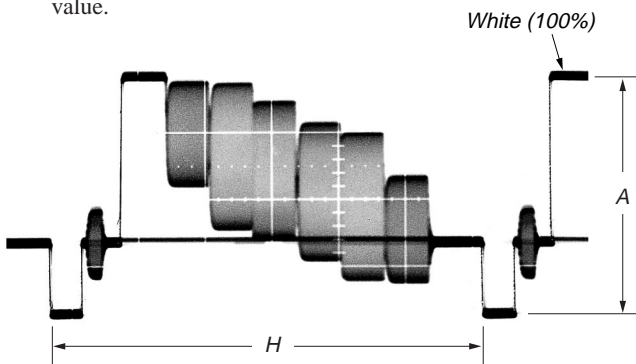

Fig. 6-2-7.

2-5-3. Deviation Check (MA-359 board)

[Adjustment purpose]

Confirm that the YFM signal deviation is within the specification.

Mode	Recording and playback (SP mode)
Signal	Color bar
Measurement Point	CN200 ⑪ pin (EEV PB) (Note1) JW234 (IC001 ⑱ pin : ARCVY) (Note2)
Measuring Instrument	Oscilloscope
Specified Value	A=2.00 ± 0.18V

Note 1: For SLV-SF99 model. (Except B model)

Note 2: For SLV-SE85/SF90 or B model.

Note 3: This check should be carried out upon completion of "Playback Level Check" and "Sync AGC Check".

Switch setting:

INPUT SELECT L2

[Check method]

- 1) Record the color bar signal.
- 2) Playback the recorded section.
- 3) Check that the video signal level (A) satisfies the specified value.

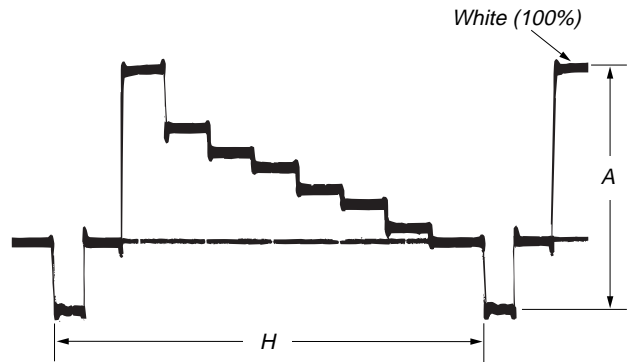

Fig. 6-2-6.

**2-5-4. DNR Y Level Adjustment (NR-27 board)
(SLV-SF99 model only. (Except B model))**

[Adjustment purpose]

Adjust the Y level during DNR ON.

Mode	Playback
Signal	Alignment tape: SP mode color bar portion
Measurement Point	CN001 ⑨ pin (DNR Y)
Measuring Instrument	Oscilloscope
Adjusting element	RV002
Specified Value	A=2.0 ± 0.2V

Switch setting:

DNR ON

[Adjusting method]

- 1) Adjust the Y signal level (A) to the specified value with RV002.

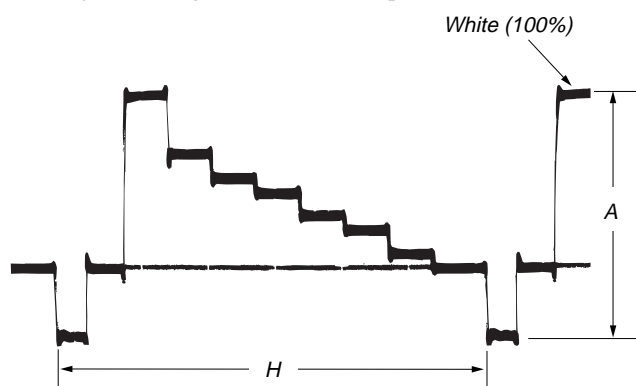

Fig. 6-2-7.

**2-5-5. DNR C Level Adjustment (NR-27 board)
(SLV-SF99 model only. (Except B model))**

[Adjustment purpose]

Adjust the chroma level during DNR ON.

Mode	Playback
Signal	Alignment tape: SP mode color bar portion
Measurement Point	CN001 ⑤ pin (DNR C)
Measuring Instrument	Oscilloscope
Adjusting element	RV001
Specified Value	A=600 ± 70mV

Switch setting:

DNR ON

[Adjusting method]

- 1) Adjust the burst signal level (A) to the specified value with RV001.

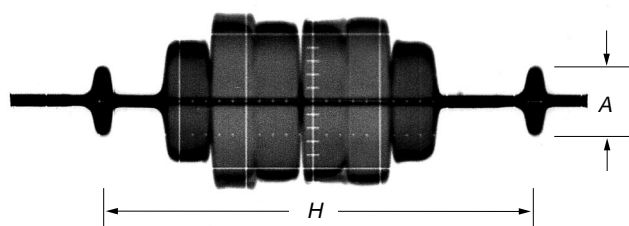

Fig. 6-2-8.

2-6. AUDIO SYSTEM ADJUSTMENT

[Connecting Instruments]

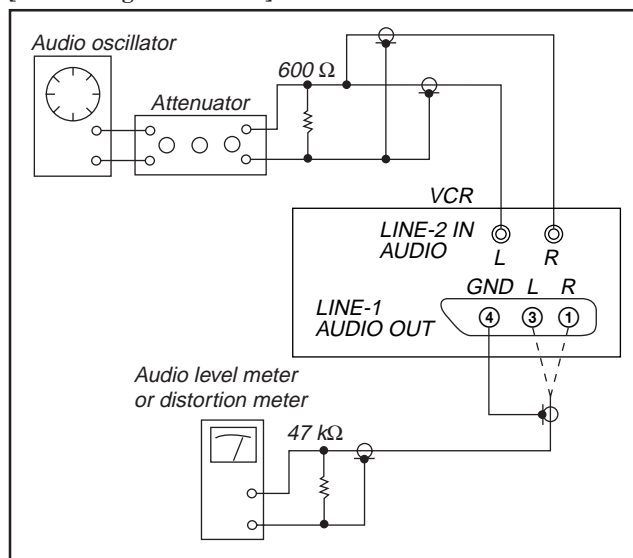

Fig. 6-2-9.

2-6-1. Hi-Fi Audio System Check

2-6-1-1. E-E Output Level Check

[Adjustment purpose]

Confirm that the E-E audio output level is within the specification.

Mode	E-E
Signal	400Hz, -7.5dB
Measurement Point	LINE1 A(L) OUT (CN500 ③ pin) or LINE1 A(R) OUT (CN500 ① pin)
Measuring Instrument	Audio level meter
Specified Value	-6.3 ± 2dBs

Switch setting:

INPUT SELECT L2

[Check method]

- 1) Input a 400Hz, -7.5dBs signal to both L and R channels of AUDIO LINE 2 terminal.
- 2) Check that the audio output signal satisfies the specified value.

2-6-1-2. Overall Level Characteristics Check

[Adjustment purpose]

Confirm that the level characteristic is within the specification.

Mode	Recording and playback (SP mode)
Signal	400Hz, -7.5dBs
Measurement Point	LINE1 A(L) OUT (CN500 ③ pin) or LINE1 A(R) OUT (CN500 ① pin)
Measuring Instrument	Audio level meter
Specified Value	-6.3 ± 2dBs

Switch setting:

INPUT SELECT L2

[Check method]

- 1) Input a 400Hz, -7.5dBs signal to both L and R channels of AUDIO LINE 2 terminal.
- 2) Record the signal in the SP mode.
- 3) Playback the recorded section.
- 4) Press the AUDIO MONITOR button of the remote commander and select the stereo audio mode (STEREO indicator on the display window turns on.).
- 5) Check that the 400Hz signal level satisfies the specified value.

2-6-2. Normal Audio System Adjustment

- Make adjustment in the SP mode unless otherwise specified.
- Use a normal VHS cassette tape for adjustment.

2-6-2-1. ACE Head Adjustment

Refer to the VHS mechanical adjustment manual VI (S MECHANISM) (9-921-647-11).

2-6-2-2. Frequency Response Check

[Adjustment purpose]

Confirm that the frequency characteristics are within the specification.

Mode	Recording and playback (SP mode)
Signal	①: 400Hz, -27.5dBs ②: 7kHz, -27.5dBs
Measurement Point	LINE1 A(L) OUT (CN500 ③ pin) or LINE1 A(R) OUT (CN500 ① pin)
Measuring Instrument	Audio level meter
Specified Value	0 ± 3dB

Note: Perform "E-E Output Level Check" of "Hi-Fi Audio System Check" before this adjustment.

Switch setting:

INPUT SELECT L2

[Check method]

- 1) Input a 400Hz, -27.5dBs signal to both L and R channels of AUDIO LINE 2 terminal.
- 2) Record the signal in the SP mode.
- 3) Input a 7kHz, -27.5dBs signal to both L and R channels of AUDIO LINE 2 terminal.
- 4) Record the signal in the SP mode.
- 5) Playback the recorded section.
- 6) Press the AUDIO MONITOR button of the remote commander and select the normal audio mode (STEREO indicator on the display window turns off.).
- 7) Check that the 7kHz signal level against to the 400Hz signal level satisfies the specified value.

SECTION 7
REPAIR PARTS LIST

7-1. EXPLODED VIEWS

NOTE:

- -XX, -X mean standardized parts, so they may have some differences from the original one.
- Items marked “*” are not stocked since they are seldom required for routine service. Some delay should be anticipated when ordering these items.
- The mechanical parts with no reference number in the exploded views are not supplied.

The components identified by mark Δ or dotted line with mark Δ are critical for safety. Replace only with part number specified.

Les composants identifiés par une marque Δ sont critiques pour la sécurité. Ne les remplacer que par une pièce portant le numéro spécifié.

7-1-1. FRONT PANEL AND UPPER CASE SECTION

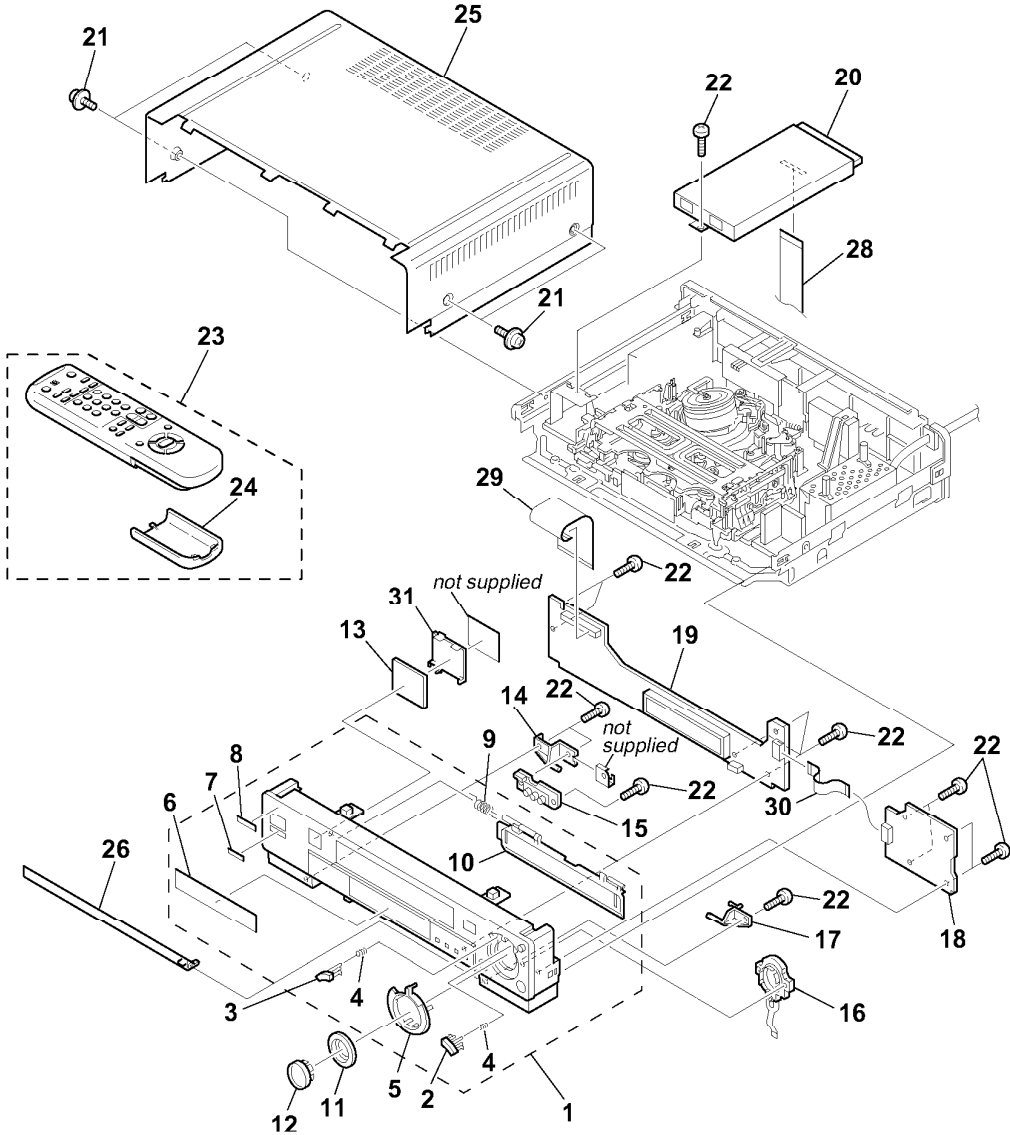

Ref. No.	Part No.	Description	Remarks	Ref. No.	Part No.	Description	Remarks
1	X-3949-563-1	PANEL ASSY, FRONT (SF90:UX(SF),EX)		* 15	A-6791-910-A	JK-171 COMPLETE PC BOARD	
1	X-3949-564-1	PANEL ASSY, FRONT (SF90:VC(SF),NP(SF))		16	1-762-844-31	SWITCH, ROTARY	
1	X-3949-565-1	PANEL ASSY, FRONT (SF90:B(SF))		17	3-054-862-11	PLATE (RIGHT), FULCRUM	
1	X-3949-566-1	PANEL ASSY, FRONT (SE85:UX)		* 18	A-6791-911-A	DM-86 COMPLETE PC BOARD	
1	X-3949-567-1	PANEL ASSY, FRONT (SE85:NP,VC)		* 19	A-6791-909-A	FR-161 COMPLETE PC BOARD (SF90:VC(WF),VC(SF))	
1	X-3949-568-1	PANEL ASSY, FRONT (SE85:B)		* 19	A-6791-921-A	FR-161 COMPLETE PC BOARD (SF90:B(WF),B(SF))	
1	X-3949-569-1	PANEL ASSY, FRONT (SF99:UX)		* 19	A-6791-927-A	FR-161 COMPLETE PC BOARD (SE85:B)	
1	X-3949-570-1	PANEL ASSY, FRONT (SF99:NP,VC)		* 19	A-6791-930-A	FR-161 COMPLETE PC BOARD (SE85:VC)	
1	X-3949-571-1	PANEL ASSY, FRONT (SF99:B)		* 19	A-6791-931-A	FR-161 COMPLETE PC BOARD (SE85:NP)	
1	X-3949-572-1	PANEL ASSY, FRONT (SF99:EN)		* 19	A-6791-932-A	FR-161 COMPLETE PC BOARD (SE85:UX)	
1	X-3949-818-1	FRONT PANEL ASSY (SF90:UX(WF))		* 19	A-6791-933-A	FR-161 COMPLETE PC BOARD (SF90:NP(WF),NP(SF))	
1	X-3949-819-1	FRONT PANEL ASSY (SF90:VC(WF),NP(WF))		* 19	A-6791-934-A	FR-161 COMPLETE PC BOARD (SF90:UX(WF),UX(SF))	
1	X-3949-820-1	FRONT PANEL ASSY (SF90:B(WF))		* 19	A-6791-935-A	FR-161 COMPLETE PC BOARD (SF90:EX)	
2	3-054-851-01	BUTTON, FF (SE85:UX,NP,VC)		* 19	A-6791-956-A	FR-161 COMPLETE PC BOARD (SF99:VC)	
2	3-054-851-11	BUTTON, FF (SF99:UX,EN,NP,VC/SF90:UX(SF),VC(SF),NP(SF),EX)		* 19	A-6791-957-A	FR-161 COMPLETE PC BOARD (SF99:EN)	
2	3-054-851-21	BUTTON, FF (SF99:B/SF90:B(SF))		* 19	A-6791-958-A	FR-161 COMPLETE PC BOARD (SF99:B)	
2	3-054-851-31	BUTTON, FF (SE85:B)		* 19	A-6791-965-A	FR-161 COMPLETE PC BOARD (SF99:NP)	
2	3-054-851-41	BUTTON, FF (SF90:UX(WF),VC(WF),NP(WF))		* 19	A-6791-966-A	FR-161 COMPLETE PC BOARD (SF99:UX)	
2	3-054-851-51	BUTTON, FF (SF90:B(WF))		* 20	A-6713-519-A	ML-17 COMPLETE PC BOARD (SF99:B/SF90:B(WF),B(SF))	
3	3-054-852-01	BUTTON, REW (SE85:UX,NP,VC)		* 20	A-6713-520-A	ML-17 COMPLETE PC BOARD (SF99:EN)	
3	3-054-852-11	BUTTON, REW (SF99:UX,EN,NP,VC/SF90:UX(SF),VC(SF),NP(SF),EX)		* 20	A-6791-915-A	ML-17 COMPLETE PC BOARD (SF99:UX,NP,VC/SF90:UX(WF),VC(WF),NP(WF), UX(SF),VC(SF),NP(SF),EX)	
3	3-054-852-21	BUTTON, REW (SF99:B/SF90:B(SF))		21	3-363-099-01	SCREW (CASE 3 TP2) (SE85)	
3	3-054-852-31	BUTTON, REW (SE85:B)		21	3-363-099-11	SCREW (CASE 3 TP2) (SF99/SF90)	
3	3-054-852-41	BUTTON, REW (SF90:UX(WF),VC(WF),NP(WF))		22	4-921-277-41	SCREW (B2.6X8), TAPPING, BIND	
3	3-054-852-51	BUTTON, REW (SF90:B(WF))		23	1-418-010-51	COMMANDER, STANDARD(RMT-V259D) (SE85:UX,NP,VC)	
4	3-054-865-01	SPRING, COMPRESSION		23	1-418-010-61	COMMANDER, STANDARD(RMT-V259E) (SF85:B)	
5	3-054-854-01	PLATE, RING ORNAMENTAL (SE85)		23	1-418-010-71	COMMANDER, STANDARD(RMT-V259F) (SF90:UX(SF),VC(SF),NP(SF),EX)	
5	3-054-854-11	PLATE, RING ORNAMENTAL (SF99/SF90)		23	1-418-010-81	COMMANDER, STANDARD(RMT-V259G) (SF90:B(SF))	
6	3-054-858-01	FILTER (SF90:B(WF),VC(WF),NP(WF),UX(SF),B(SF),VC(SF),NP(SF),EX)		23	1-418-373-11	COMMANDER, STANDARD(RMT-V260) (SF99:EN)	
7	3-054-855-01	WINDOW, REMOTE CONTROL (SF99:UX/SF90:UX(SF),B(SF),VC(SF),NP(SF),EX/SE85)		23	1-418-374-11	COMMANDER, STANDARD(RMT-V260A) (SF99:UX,NP,VC)	
7	3-054-855-11	WINDOW, REMOTE CONTROL (SF99:EN,NP,B,VC/SF90:UX(WF),B(WF),VC(WF),NP(WF))		23	1-418-374-21	COMMANDER, STANDARD(RMT-V260B) (SF99:B)	
8	3-943-995-01	EMBLEM (NO.5), SONY (SE85)		23	1-418-624-11	COMMANDER, STANDARD(RMT-V259H) (SF90:UX(WF),VC(WF),NP(WF))	
8	3-943-995-31	EMBLEM (NO.5), SONY (SF99/SF90:UX(SF),B(SF),VC(SF),NP(SF),EX)		23	1-418-624-21	COMMANDER, STANDARD(RMT-V259J) (SF90:B(WF))	
8	3-943-995-41	EMBLEM (NO.5), SONY (SF90:UX(WF),B(WF),VC(WF),NP(WF))		* 25	3-987-684-21	CASE (BN), UPPER (SE85)	
9	3-953-432-01	SPRING (GE), FL		25	3-987-684-91	CASE (BN), UPPER (SF90:UX(WF),B(WF),VC(WF),NP(WF))	
10	3-054-846-11	DOOR (DD), CASSETTE (SF99:UX,EN,NP,VC/SF90:UX(SF),VC(SF),NP(SF),EX)		26	1-418-389-11	SWITCH BLOCK, CONTROL (SF90:UX(SF),VC(SF),NP(SF),EX)	
10	3-054-846-21	DOOR (DD), CASSETTE (SE85:UX,NP,VC)		26	1-418-389-21	SWITCH BLOCK, CONTROL (SF90:B(SF))	
10	3-054-846-31	DOOR (DD), CASSETTE (SF99:B/SF90:B(SF))		26	1-418-389-31	SWITCH BLOCK, CONTROL (SF99:UX,EN,NP,VC)	
10	3-054-846-41	DOOR (DD), CASSETTE (SE85:B)		26	1-418-389-41	SWITCH BLOCK, CONTROL (SF99:B)	
10	3-054-846-51	DOOR (DD), CASSETTE (SF90:UX(WF),VC(WF),NP(WF))		26	1-418-389-51	SWITCH BLOCK, CONTROL (SF90:UX(WF),VC(WF),NP(WF))	
10	3-054-846-61	DOOR (DD), CASSETTE (SF90:B(WF))		26	1-418-389-61	SWITCH BLOCK, CONTROL (SF90:B(WF))	
11	3-054-859-11	RING (DD), JOG (SF99/SF90:UX(SF),B(SF),VC(SF),NP(SF),EX)		28	1-790-720-11	CABLE, FLAT (FFL-9)	
11	3-054-859-21	RING (DD), JOG (SE85)		29	1-790-718-11	CABLE, FLAT (FFM-31)	
11	3-054-859-31	RING (DD), JOG (SF90:UX(WF),B(WF),VC(WF),NP(WF))		30	1-790-719-11	CABLE, FLAT (FFD-5)	
12	3-054-860-11	BUTTON (DD), CENTER (SF99:UX,EN,NP,VC/SF90:UX(SF),VC(SF),NP(SF),EX)		31	3-054-863-11	HOLDER(DD), SHIELD	
12	3-054-860-21	BUTTON (DD), CENTER (SF99:B/SF90:B(SF))					
12	3-054-860-31	BUTTON (DD), CENTER (SE85:UX,NP,VC)					
12	3-054-860-41	BUTTON (DD), CENTER (SE85:B)					
12	3-054-860-51	BUTTON (DD), CENTER (SF90:UX(WF),VC(WF),NP(WF))					
12	3-054-860-61	BUTTON (DD), CENTER (SF90:B(WF))					
* 13	A-6791-912-A	AT-26 COMPLETE PC BOARD (SF99/SF90)					
14	3-054-864-11	PLATE (LEFT), FULCRUM					

7-1-2. CHASSIS SECTION

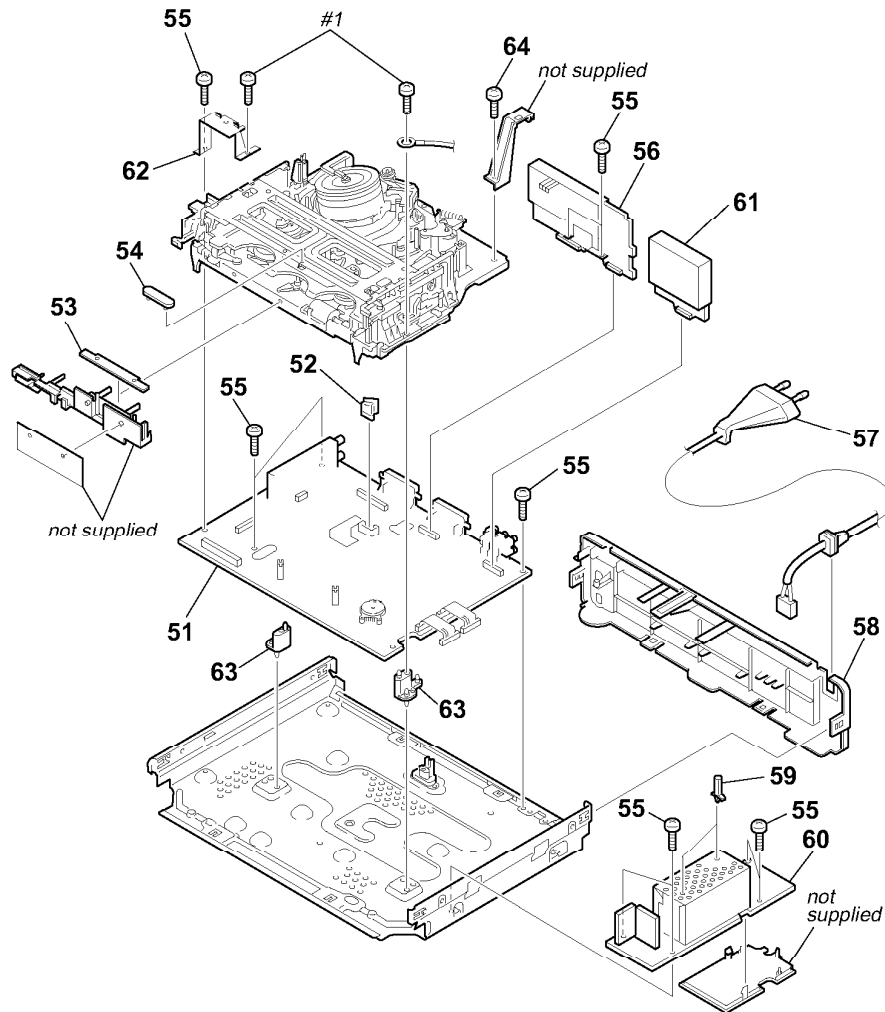

Ref. No.	Part No.	Description	Remarks	Ref. No.	Part No.	Description	Remarks
* 51	A-6791-913-A	MA-359 COMPLETE PC BOARD (SF90:VC(WF),VC(SF))		* 56	A-6791-971-A	RP-235 COMPLETE PC BOARD (SF99)	
* 51	A-6791-917-A	MA-359 COMPLETE PC BOARD (SF90:UX(WF),UX(SF))		△57	1-782-012-11	CORD, POWER (SE85)	
* 51	A-6791-919-A	MA-359 COMPLETE PC BOARD (SF90:EX)		△57	1-783-931-11	CORD, POWER (SF99/SF90)	
* 51	A-6791-920-A	MA-359 COMPLETE PC BOARD (SF90:NP(WF),NP(SF))		58	3-053-407-41	PANEL (BN), REAR (SF90:B(WF),VG(WF),NP(WF),B(SF),VG(SF),NP(SF))	
* 51	A-6791-922-A	MA-359 COMPLETE PC BOARD (SF90:D(WF),D(SF))		58	3-053-407-51	PANEL (BN), REAR (SF90:UX(WF),UX(SF),EX)	
* 51	A-6791-924-A	MA-359 COMPLETE PC BOARD (SE85:VC)		58	3-053-407-61	PANEL (BN), REAR (SE85:B,NP,VC)	
* 51	A-6791-926-A	MA-359 COMPLETE PC BOARD (SE85:UX)		58	3-053-407-71	PANEL (DN), REAR (SE85:UX)	
* 51	A-6791-928-A	MA-359 COMPLETE PC BOARD (SE85:B)		58	3-053-407-81	PANEL (BN), REAR (SF99:EN)	
* 51	A-6791-929-A	MA-359 COMPLETE PC BOARD (SE85:NP)		58	3-053-407-91	PANEL (BN), REAR (SF99:NP,B,VC)	
* 51	A-6791-960-A	MA-359 COMPLETE PC BOARD (SF99:EN)		58	3-054-654-01	PANEL, REAR (SF99:UX)	
* 51	A-6791-961-A	MA-359 COMPLETE PC BOARD (SF99:VC)		59	3-670-570-71	SPACER, SUPPORT	
* 51	A-6791-962-A	MA-359 COMPLETE PC BOARD (SF99:NP)		△60	1-468-398-11	POWER BLOCK	
* 51	A-6791-963-A	MA-359 COMPLETE PC BOARD (SF99:B)		* 61	A-6791-959-A	NR-27 COMPLETE PC BOARD (SF99:UX,EN,NP,VC)	
* 51	A-6791-964-A	MA-359 COMPLETE PC BOARD (SF99:UX)		* 61	A-6791-918-A	SE-90 COMPLETE PC BOARD (SF85:EXCEPT B/SF90:EXCEPT B(WF),B(SF),SF99)	
52	1-779-725-11	CONNECTOR, BOARD TO BOARD 5P		* 61	A-6791-923-A	SE-90 COMPLETE PC BOARD (SF99:B/SF90:B(WF),B(SF)/SE85:B)	
* 53	A-6791-916-A	AT-25 COMPLETE PC BOARD (SF99/SF90)		62	3-050-878-01	HOLDER, ML (SF99/SF90)	
54	3-978-737-11	CUSHION (FP), RUBBER		63	3-959-381-01	BASE (L), MD	
55	3-970-608-21	SUMITITE (B3), +BV		64	3-979-508-01	SCREW +HEXA TP SW 3X8	
* 56	A-6791-914-A	RP-235 COMPLETE PC BOARD (SF90)					
* 56	A-6791-925-A	RP-235 COMPLETE PC BOARD (SE85)					

Note :
The components identified by
mark △ or dotted line with mark

Note :
Les composants identifiés par
une marque △ sont critiques

7-1-3. MECHANISM DECK SECTION-1

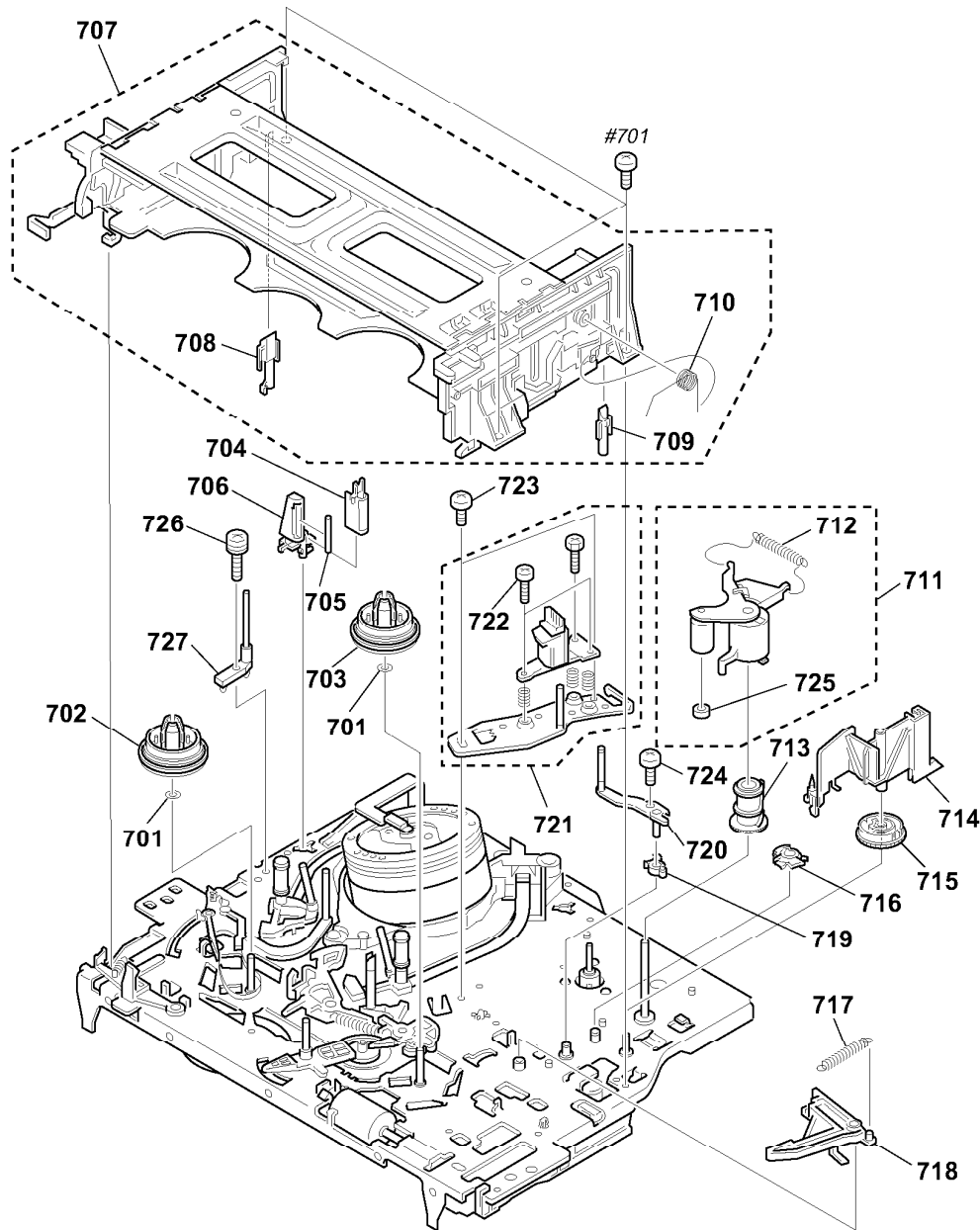

Ref. No.	Part No.	Description	Remarks	Ref. No.	Part No.	Description	Remarks
701	3-977-509-01	WASHER, THRUST		715	3-977-441-03	GEAR, PINCH PRESSING	
702	3-977-507-01	TABLE, REEL (S)		716	3-977-445-02	GEAR, TG8 ARM DRIVING	
703	3-977-508-01	TABLE, REEL (T)		717	3-977-465-01	SPRING,EXTENSION(RVS BRAKE)	
704	1-500-144-11	HEAD, FE		718	X-3947-582-1	ARM ASSY, RVS BRAKE	
705	3-977-495-01	SHAFT TG2		719	3-977-446-01	GEAR. TG8 ARM	
706	3-977-494-01	HOLDER, FEH		720	X-3947-590-1	TG8 ASSY	
707	A-6759-619-B	FL COMPLETE ASSY		721	A-6775-052-A	ACE BLOCK ASSY (ALPS)(EURO 2)	
708	3-977-535-01	PLATE, LUMINOUS(END SENSOR)		722	3-974-556-11	+ HEXA TT 2.6X9 (TAPER)	
709	3-977-536-01	PLATE, LUMINOUS (TOP SENSOR)		723	3-979-508-01	SCREW +HEXA TP SW 3X8	
710	3-970-471-01	SPRING (DECK OPEN), TORSION		724	3-719-381-01	SCREW (M2X4)	
711	A-6759-615-A	PRESS BLOCK ASSY, PINCH		725	3-736-045-01	BEARING (NO FLANG), BALL	
712	3-958-455-01	SPRING (PINCH), TENSION		726	3-979-112-01	SCREW SW(+)BVTP 3X10	
713	3-977-447-01	GEAR, ELEVATOR		727	X-3949-549-1	TG 0 ASSY	
714	3-977-514-01	OPENER, LID					

7-1-4. MECHANISM DECK SECTION-2

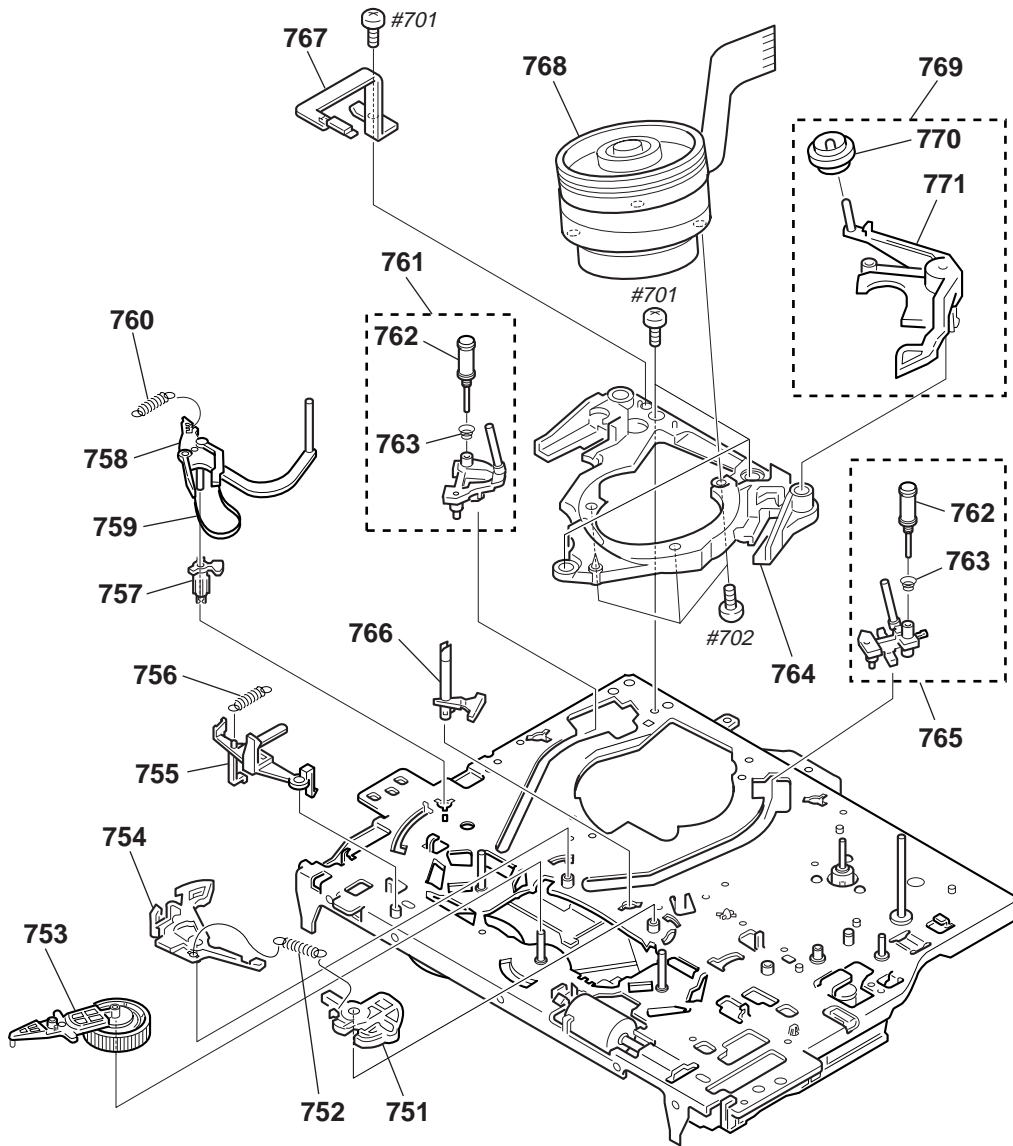

Ref. No.	Part No.	Description	Remarks	Ref. No.	Part No.	Description	Remarks
751	X-3949-363-1	BRAKE ASSY, MAIN (T)		763	3-965-178-01	SPRING	
752	3-053-882-01	SPRING, TENS (MAIN BRAKE)		764	3-969-632-04	BASE, DRUM	
753	X-3947-573-1	ARM ASSY, PENDULUM		765	A-6759-630-A	SHUTTLE (T) BLOCK ASSY	
754	X-3949-362-1	BRAKE ASSY, MAIN (S)		766	3-977-501-01	PLATE, LUMINOUS	
755	3-977-513-02	LEVER, REC. PROOF		767	X-3943-899-8	GROUND ASSY, SHAFT	
756	3-976-767-01	SPRING, TENS. (REC. PROOF)		768	1-759-373-22	DRUM ASSY (DZH-86A-R)	(SE85:NP,VC,UX/SF90:NP,VC,UX,EX/SF99:EN,NP,UX,VC)
757	3-977-487-01	BOSS, TG1 FULCRUM		768	1-759-557-22	DRUM ASSY (DZH-98A-R)	(SE85:B/SF90:B/SF99:B)
758	X-3947-587-1	TG1 ASSY		769	A-6746-074-G	ROLLER BLOCK ASSY, HC	
759	X-3947-589-1	BAND ASSY, TG1		770	X-3947-255-1	ROLLER ASSY, HC	
760	3-977-488-01	SPRING (POWER TENSION)		771	3-975-724-07	ARM, HC	
761	A-6750-324-A	SHUTTLE (S) BLOCK ASSY					
762	X-3948-050-1	ROLLER ASSY, GUIDE					

7-1-5. MECHANISM DECK SECTION-3

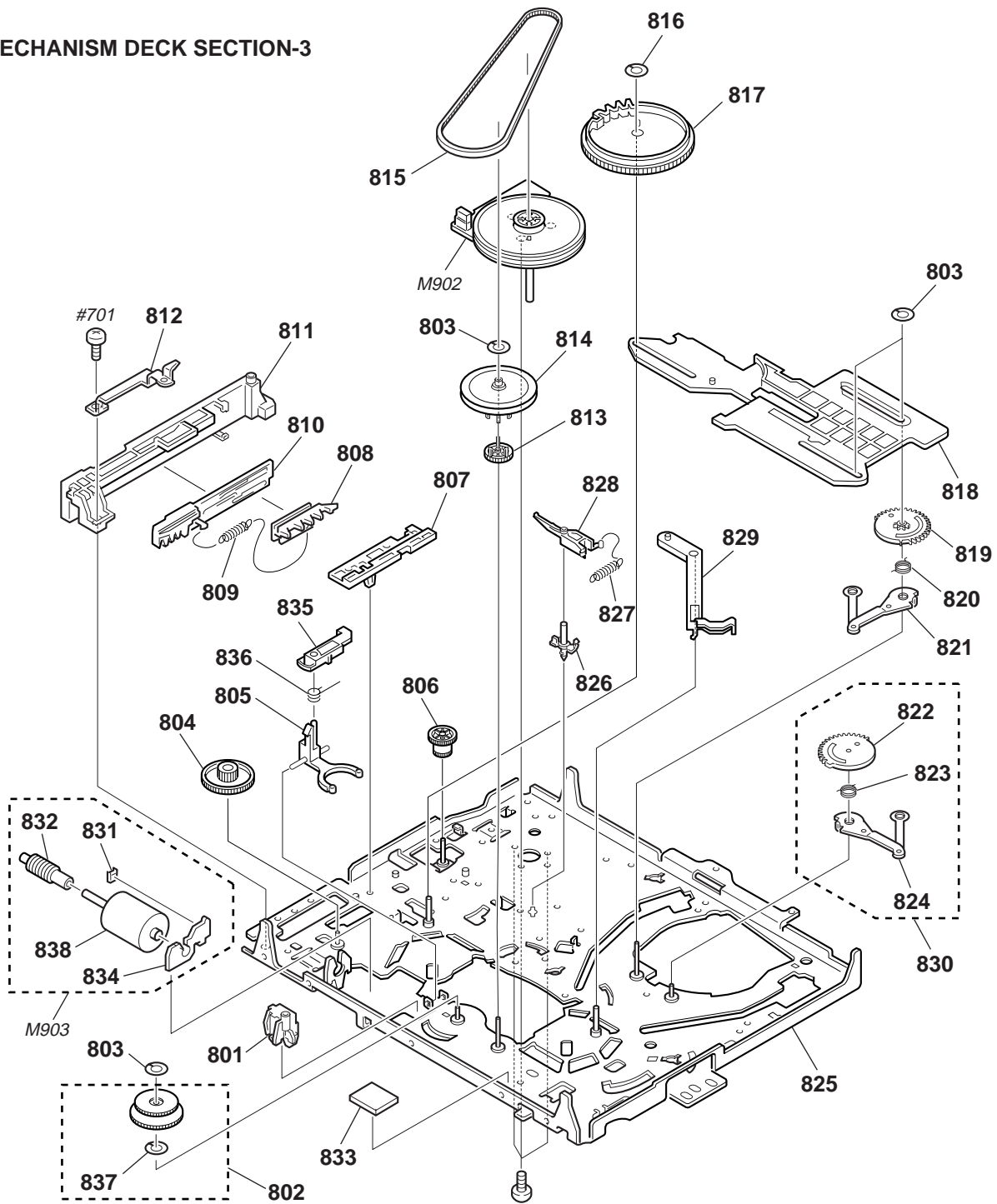

Ref. No.	Part No.	Description	Remarks	Ref. No.	Part No.	Description	Remarks
801	3-977-437-01	RETAINER,CAM MOTOR		821	X-3947-579-1	LEVER ASSY, LOADING(T)	
802	X-3949-364-1	ASSY, REEL DIRECT SELECT (B)		822	3-977-451-01	GEAR, LOADING(S)	
803	3-977-443-01	WASHER, STOPPER		823	3-977-452-01	SPRING, TORSION (LOAD S)	
804	3-977-438-01	WORM - WHEEL		824	X-3947-578-1	LEVER ASSY, LOADING(S)	
805	3-053-888-01	BASE, DIRECT SELECT (B)		825	X-3947-576-2	CHASSIS ASSY, MECHANICAL	
806	3-977-444-01	GEAR, PINCH TRANSMISSION		826	3-977-468-01	SHAFT, CAPSTAN BRAKE	
807	3-977-515-01	GUIDE, FL SLIDER		827	3-977-467-02	SPRING, CAP BRAKE	
808	3-977-517-01	PLATE, SLIDE, FL		828	X-3947-583-1	BRAKE ASSY, CAPSTAN	
809	3-977-519-01	SPRING, TENS. (LIMIT, FL)		829	3-977-489-01	ARM, TG1 DRIVING	
810	3-977-518-02	PLATE, LIMITTER, FL		830	A-6759-616-A	GEAR BLOCK ASSY, LOADING(S)	
811	3-977-516-01	HOLDER, FL SLIDER		831	1-766-723-21	CONNECTOR, BOARD TO BOARD 3P	
812	3-977-877-01	PLATE, RETAINER		832	3-977-436-01	WORM	
813	3-977-504-01	GEAR, CLUTCH		833	3-989-917-01	SPACER (REC PROOF)	
814	X-3949-365-1	GEAR ASSY PULLEY (B)		834	1-666-524-11	PWB, CA-55	
815	3-977-510-01	BELT, RUBBER		835	3-053-887-01	ARM, DIRECT SELECT (B)	
816	3-977-440-01	WASHER, STOPPER		836	3-053-889-01	SPRING, TORSION(DIRECT SELECT)	
817	3-977-439-01	GEAR, CAM		837	3-974-477-01	WASHER, (GEAR, LIMITTER)	
818	3-053-878-01	SLIDER (B)		838	1-541-309-11	MOTOR, L (RF-370C)	
819	3-977-455-01	GEAR, LOADING(T)		M902	1-698-971-11	MOTOR, DC (CAPSTAN)	
820	3-977-456-03	SPRING, TORSION (LOAD T)		M903	X-3947-577-1	MOTOR ASSY, CAM	

7-2. ELECTRICAL PARTS LIST

NOTE:

- Due to standardization, replacements in the parts list may be different from the parts specified in the diagrams or the components used on the set.
- -XX, -X mean standardized parts, so they may have some difference from the original one.
- Items marked "*" are not stocked since they are seldom required for routine service. Some delay should be anticipated when ordering these items.
- CAPACITORS:
uF: μF

- RESISTORS
All resistors are in ohms.
METAL: metal-film resistor
METAL OXIDE: Metal Oxide-film resistor
F: nonflammable
- COILS
uH: μH
- SEMICONDUCTORS
In each case, u: μ, for example:
uA...: μA..., uPA..., μPA...,
uPB..., μPB..., uPC..., μPC...,
uPD..., μPD...

When indicating parts by reference number, please include the board name.

The components identified by mark Δ or dotted line with mark Δ are critical for safety. Replace only with part number specified.

Les composants identifiés par une marque Δ sont critiques pour la sécurité. Ne les remplacer que par une pièce portant le numéro spécifié.

Ref. No.	Part No.	Description	Remarks
*	A-6791-916-A	AT-25 COMPLETE BOARD, COMPLETE (SF90/SF99) ***** (Ref.No.:2000 Series)	
	3-987-343-11	HOLDER, AN < CAPACITOR >	
C991	1-163-136-00	CERAMIC CHIP 620PF 1% 50V < CONNECTOR >	
CN990	1-506-468-11	PIN, CONNECTOR 3P < RESISTOR >	
R990	1-216-295-91	SHORT 0	
R991	1-216-295-91	SHORT 0	
*	A-6791-912-A	AT-26 COMPLETE BOARD, COMPLETE (SF90/SF99) ***** (Ref.No.:2000 Series)	
	3-054-863-11	HOLDER (DD), SHIELD (SF90/SF99) < CAPACITOR >	
C995	1-125-830-91	CERAMIC CHIP 680PF 1% 50V (SF90/SF99)	
C996	1-163-245-11	CERAMIC CHIP 56PF 5% 50V (SF90/SF99) < CONNECTOR >	
CN995	1-506-468-11	PIN, CONNECTOR 3P (SF90/SF99)	

Ref. No.	Part No.	Description	Remarks
*	A-6791-911-A	DM-86 COMPLETE BOARD, COMPLETE ***** (Ref.No.:3000 Series)	
	1-790-719-11	CABLE, FLAT (FFD-5) < CAPACITOR >	
C451	1-163-038-91	CERAMIC CHIP 0.1uF 25V < CONNECTOR >	
CN451	1-784-484-11	CONNECTOR, FFC/FPC 5P	
CN452	1-784-449-11	CONNECTOR, FFC/FPC 7P < DIODE >	
D459	8-719-056-06	DIODE SLR-342DCT31(JOG) < RESISTOR >	
R459	1-216-033-00	METAL CHIP 220 5% 1/10W	
R464	1-216-057-00	METAL CHIP 2.2K 5% 1/10W	
R465	1-216-073-00	METAL CHIP 10K 5% 1/10W	
R466	1-216-073-00	METAL CHIP 10K 5% 1/10W	
R467	1-216-057-00	METAL CHIP 2.2K 5% 1/10W	
R468	1-216-057-00	METAL CHIP 2.2K 5% 1/10W	
R469	1-216-057-00	METAL CHIP 2.2K 5% 1/10W	
R471	1-216-061-00	METAL CHIP 3.3K 5% 1/10W	
R472	1-216-065-91	RES.CHIP 4.7K 5% 1/10W < SWITCH >	
S451	1-771-410-21	SWITCH, TACT(● REC)	
S453	1-771-410-21	SWITCH, TACT(◀◀ REW)	
S457	1-771-410-21	SWITCH, TACT(▶▶ FF)	
S458	1-771-410-21	SWITCH, TACT(■ PAUSE)	
S459	1-771-410-21	SWITCH, TACT(JOG)	

FR-161

Ref. No.	Part No.	Description	Remarks	Ref. No.	Part No.	Description	Remarks
*	A-6791-909-A	FR-161 COMPLETE BOARD, COMPLETE (SF90:VC(WF),VC(SF)) *****				< CAPACITOR >	
*	A-6791-921-A	FR-161 COMPLETE BOARD, COMPLETE (SF90:B(WF),B(SF)) *****		C180	1-163-038-91	CERAMIC CHIP 0.1uF	25V (EXCEPT SF99:UX)
*	A-6791-927-A	FR-161 COMPLETE BOARD, COMPLETE (SE85:B) *****		C188	1-163-104-00	CERAMIC CHIP 30PF	5% 50V (EXCEPT SF99:UX)
*	A-6791-930-A	FR-161 COMPLETE BOARD, COMPLETE (SE85:VC) *****		C190	1-115-456-21	DOUBLE LAYER 0.22F	0 5.5V (EXCEPT SF99:UX)
*	A-6791-931-A	FR-161 COMPLETE BOARD, COMPLETE (SE85:NP) *****		C191	1-163-038-91	CERAMIC CHIP 0.1uF	25V (EXCEPT SF99:UX)
*	A-6791-932-A	FR-161 COMPLETE BOARD, COMPLETE (SE85:UX) *****		C192	1-126-916-11	ELECT 1000uF	20% 6.3V (EXCEPT SF99:UX)
*	A-6791-933-A	FR-161 COMPLETE BOARD, COMPLETE (SF90:NP(WF),NP(SF)) *****		C193	1-163-031-11	CERAMIC CHIP 0.01uF	50V (EXCEPT SF99:UX)
*	A-6791-934-A	FR-161 COMPLETE BOARD, COMPLETE (SF90:UX(WF),UX(SF)) *****		C196	1-128-057-11	ELECT 330uF	20% 6.3V (EXCEPT SF99:UX)
*	A-6791-935-A	FR-161 COMPLETE BOARD, COMPLETE (SF90:EX) *****		C198	1-163-031-11	CERAMIC CHIP 0.01uF	50V (EXCEPT SF99:UX)
*	A-6791-956-A	FR-161 COMPLETE BOARD, COMPLETE (SF99:VC) *****		C199	1-163-031-11	CERAMIC CHIP 0.01uF	50V (EXCEPT SF99:UX)
*	A-6791-957-A	FR-161 COMPLETE BOARD, COMPLETE (SF99:EN) *****		C200	1-163-038-91	CERAMIC CHIP 0.1uF	25V (EXCEPT SF99:UX)
*	A-6791-958-A	FR-161 COMPLETE BOARD, COMPLETE (SF99:B) *****		C400	1-163-809-11	CERAMIC CHIP 0.047uF	10% 25V (EXCEPT SF99:UX)
*	A-6791-965-A	FR-161 COMPLETE BOARD, COMPLETE (SF99:NP) *****		C401	1-163-231-11	CERAMIC CHIP 15PF	5% 50V (EXCEPT SF99:UX)
*	A-6791-966-A	FR-161 COMPLETE BOARD, COMPLETE (SF99:UX) ***** (Ref.No.:3000 Series)		C402	1-163-231-11	CERAMIC CHIP 15PF	5% 50V (EXCEPT SF99:UX)
	1-790-718-11	CABLE, FLAT (FFM-31) < BUZZER >		C403	1-163-231-11	CERAMIC CHIP 15PF	5% 50V (EXCEPT SF99:UX)
BZ181	1-529-104-11	BUZZER, PIEZOELECTRIC (EXCEPT SF99:UX)		C421	1-165-319-11	CERAMIC CHIP 0.1uF	50V (EXCEPT SF99:UX)
				C422	1-104-664-11	ELECT 47uF	20% 16V (EXCEPT SF99:UX)
				C423	1-163-031-11	CERAMIC CHIP 0.01uF	50V (EXCEPT SF99:UX)
				C424	1-165-319-11	CERAMIC CHIP 0.1uF	50V (EXCEPT SF99:UX)
				C495	1-163-038-91	CERAMIC CHIP 0.1uF	25V (EXCEPT SF99:UX)
				C496	1-163-038-91	CERAMIC CHIP 0.1uF	25V (EXCEPT SF99:UX)
				C497	1-163-263-11	CERAMIC CHIP 330PF	5% 50V (EXCEPT SF99:UX)
						< CONNECTOR >	
				CN400	1-784-449-11	CONNECTOR, FFC/FPC 7P (EXCEPT SF99:UX)	
				CN401	1-695-328-11	PIN, CONNECTOR (PC BOARD) 5P (SF90/SF99)	
				CN402	1-784-512-11	CONNECTOR, FFC/FPC 33P	
						< TRIMMER >	
				CT180	1-141-442-91	CAP, CERAMIC TRIMMER 20PF	(EXCEPT SF99:UX)
						< DIODE >	
				D188	8-719-075-84	DIODE S1G-G2P (EXCEPT SF99:UX)	
				D189	8-719-075-84	DIODE S1G-G2P (EXCEPT SF99:UX)	
				D400	8-719-056-07	DIODE SLR-342MCT31 (EXCEPT SF99:UX)	
				D420	8-719-070-61	DIODE PDZ8.2B-115 (EXCEPT SF99:UX)	
				D421	8-719-056-06	DIODE SLR-342DCT31 (SF99:UX,EN,NP,VC)	

Ref. No.	Part No.	Description	Remarks	Ref. No.	Part No.	Description	Remarks
D422	8-719-056-06	DIODE SLR-342DCT31 (EXCEPT SF99:UX)		R185	1-216-073-00	METAL CHIP 10K	5% 1/10W
D423	8-719-056-06	DIODE SLR-342DCT31 (SF90/SF99)		R188	1-216-049-91	RES,CHIP 1K	5% 1/10W
		< FERRITE BEAD >		R189	1-216-041-00	METAL CHIP 470	5% 1/10W
FB407	1-414-234-22	INDUCTOR CHIP OUH (SF90/SF99)		R191	1-216-073-00	METAL CHIP 10K	5% 1/10W
FB407	1-216-295-91	SHORT 0 (SE85)		R192	1-216-049-91	RES,CHIP 1K	5% 1/10W
FB408	1-414-234-22	INDUCTOR CHIP OUH (SF90/SF99)		R194	1-216-041-00	METAL CHIP 470	5% 1/10W
FB408	1-216-295-91	SHORT 0 (SE85)		R195	1-216-049-91	RES,CHIP 1K	5% 1/10W
FB409	1-414-234-22	INDUCTOR CHIP OUH (SF90/SF99)		R196	1-216-049-91	RES,CHIP 1K	5% 1/10W
FB409	1-216-295-91	SHORT 0 (SE85)		R197	1-216-049-91	RES,CHIP 1K	5% 1/10W
FB410	1-414-234-22	INDUCTOR CHIP OUH (SF90/SF99)		R198	1-216-049-91	RES,CHIP 1K	5% 1/10W
FB410	1-216-295-91	SHORT 0 (SE85)		R199	1-216-037-00	METAL CHIP 330	5% 1/10W
		< FERRITE BEAD >		R201	1-216-295-91	SHORT 0	
FB411	1-500-245-11	INDUCTOR CHIP OUH (EXCEPT SF99:UX)		R202	1-216-095-00	METAL CHIP 82K	5% 1/10W
FB412	1-500-245-11	INDUCTOR CHIP OUH (EXCEPT SF99:UX)		R203	1-216-113-00	METAL CHIP 470K	5% 1/10W
		< IC >		R204	1-218-179-11	RES,CHIP 10M	5% 1/10W
IC180	8-759-576-20	IC S579658PJ (SF99:UX,NP,VC)		R205	1-216-041-00	METAL CHIP 470	5% 1/10W (EXCEPT SF90:B(SF))
IC180	8-759-576-21	IC S579659PJ (SF99:B)		R206	1-216-073-00	METAL CHIP 10K	5% 1/10W (EXCEPT SF90:B(SF))
IC180	8-759-576-22	IC S579660PJ (SF90:UX(WF),VC(WF),NP(WF),UX(SF), VC(SF),NP(SF),EX/SE85:UX,NP,VC)		R400	1-216-029-00	METAL CHIP 150	5% 1/10W
IC180	8-759-576-23	IC S579661PJ (SF90:B(WF),B(SF)/SE85:B)		R401	1-216-089-91	RES,CHIP 47K	5% 1/10W
IC180	8-759-576-24	IC S579662PJ (SF99:EN)		R405	1-216-095-00	METAL CHIP 82K	5% 1/10W (SF90/SF99)
IC182	8-759-527-77	IC M24C16-MN6T (EXCEPT SF99:UX)		R405	1-216-073-00	METAL CHIP 10K	5% 1/10W (SE85)
IC183	8-759-248-87	IC MM1256XF-BE (EXCEPT SF99:UX)		R406	1-216-073-00	METAL CHIP 10K	5% 1/10W
IC400	8-749-011-05	IC GP1U28X (EXCEPT SF99:UX)		R407	1-216-073-00	METAL CHIP 10K	5% 1/10W
IC420	8-759-438-82	IC uPD16311GC-AB6 (EXCEPT SF99:UX)		R408	1-216-061-00	METAL CHIP 3.3K	5% 1/10W (SF90/SF99)
		< JUMPER RESISTOR >		R408	1-216-057-00	METAL CHIP 2.2K	5% 1/10W (SE85)
JR401	1-216-295-91	SHORT 0 (EXCEPT SF99:UX)		R409	1-216-067-00	METAL CHIP 5.6K	5% 1/10W (SF90/SF99)
JR402	1-216-296-91	SHORT 0 (EXCEPT SF99:UX)		R409	1-216-057-00	METAL CHIP 2.2K	5% 1/10W (SE85)
JR403	1-216-296-91	SHORT 0 (EXCEPT SF99:UX)		R410	1-216-095-00	METAL CHIP 82K	5% 1/10W (SF90/SF99)
JR404	1-216-295-91	SHORT 0 (EXCEPT SF99:UX)		R410	1-216-073-00	METAL CHIP 10K	5% 1/10W (SE85)
JR405	1-216-296-91	SHORT 0 (EXCEPT SF99:UX)		R411	1-216-295-91	SHORT 0 (SF90/SF99)	
JR406	1-216-296-91	SHORT 0 (EXCEPT SF99:UX)		R411	1-216-057-00	METAL CHIP 2.2K	5% 1/10W (SE85)
JR407	1-216-295-91	SHORT 0 (EXCEPT SF99:UX)		R412	1-216-057-00	METAL CHIP 2.2K	5% 1/10W (SF90/SF99)
JS181	1-216-295-91	SHORT 0 (EXCEPT SF99:UX)		R413	1-216-033-00	METAL CHIP 220	5% 1/10W (SF99:UX,EN,NP,VC)
JS183	1-216-295-91	SHORT 0 (SE85)		R414	1-216-033-00	METAL CHIP 220	5% 1/10W
		< COIL >		R415	1-216-033-00	METAL CHIP 220	5% 1/10W (SF90/SF99)
L182	1-414-934-21	INDUCTOR 10uH (EXCEPT SF99:UX)		R416	1-216-057-00	METAL CHIP 2.2K	5% 1/10W
		< FLUORESCENT INDICATOR >		R418	1-216-073-00	METAL CHIP 10K	5% 1/10W
ND420	1-517-745-21	TUBE, FLUORESCENT INDICATOR		R422	1-216-049-91	RES,CHIP 1K	5% 1/10W
		< TRANSISTOR >		R423	1-216-049-91	RES,CHIP 1K	5% 1/10W
Q400	8-729-043-29	TRANSISTOR PDTTC144EK-115		R424	1-216-049-91	RES,CHIP 1K	5% 1/10W
		< RESISTOR >		R425	1-216-085-00	METAL CHIP 33K	5% 1/10W
R180	1-216-073-00	METAL CHIP 10K	5% 1/10W	R426	1-216-073-00	METAL CHIP 10K	5% 1/10W
R181	1-216-073-00	METAL CHIP 10K	5% 1/10W	R427	1-216-069-00	METAL CHIP 6.8K	5% 1/10W
R182	1-216-295-91	SHORT 0		R428	1-216-073-00	METAL CHIP 10K	5% 1/10W
R183	1-216-295-91	SHORT 0		R429	1-216-065-91	RES,CHIP 4.7K	5% 1/10W
R184	1-216-113-00	METAL CHIP 470K	5% 1/10W				

FR-161**JK-171****MA-359**

Ref. No.	Part No.	Description	Quantity	Remarks
R430	1-216-073-00	METAL CHIP	10K	5% 1/10W
R492	1-216-037-00	METAL CHIP	330	5% 1/10W
< SWITCH >				
S400	1-771-410-21	SWITCH, TACT		
S401	1-771-410-21	SWITCH, TACT		
S402	1-771-410-21	SWITCH, TACT		
S403	1-771-410-21	SWITCH, TACT		
S404	1-771-410-21	SWITCH, TACT		
S405	1-771-410-21	SWITCH, TACT		
< VIBRATOR >				
X180	1-760-014-11	VIBRATOR, CERAMIC		
X181	1-579-463-11	VIBRATOR, CRYSTAL		
*	A-6791-910-A	JK-171 COMPLETE BOARD, COMPLETE ***** (Ref.No.:3000 Series)		
< CAPACITOR >				
C481	1-163-009-11	CERAMIC CHIP	0.001uF	10% 50V
C491	1-163-009-11	CERAMIC CHIP	0.001uF	10% 50V
C493	1-163-009-11	CERAMIC CHIP	0.001uF	10% 50V
< CONNECTOR >				
* CN480	1-568-954-11	PIN, CONNECTOR 5P		
< DIODE >				
D480	8-719-070-59	DIODE PDZ6.8B-115		
D490	8-719-071-50	DIODE BZA408B-115		
< JACK >				
J480	1-774-509-11	JACK, PIN 3P		
< JUMPER RESISTOR >				
JR480	1-216-296-91	SHORT	0	
JR481	1-216-295-91	SHORT	0	
JS490	1-216-295-91	SHORT	0	
< RESISTOR >				
R480	1-216-022-00	METAL CHIP	75	5% 1/10W
R481	1-216-295-91	SHORT	0	
R490	1-216-295-91	SHORT	0	
R491	1-216-295-91	SHORT	0	

Ref. No.	Part No.	Description	Quantity	Remarks
*	A-6791-913-A	MA-359 COMPLETE BOARD, COMPLETE (SF90:VC(WF),VC(SF)) *****		
*	A-6791-917-A	MA-359 COMPLETE BOARD, COMPLETE (SF90:UX(WF),UX(SF)) *****		
*	A-6791-919-A	MA-359 COMPLETE BOARD, COMPLETE (SF90:EX) *****		
*	A-6791-920-A	MA-359 COMPLETE BOARD, COMPLETE (SF90:NP(WF),NP(SF)) *****		
*	A-6791-922-A	MA-359 COMPLETE BOARD, COMPLETE (SF90:B(WF),B(SF)) *****		
*	A-6791-924-A	MA-359 COMPLETE BOARD, COMPLETE (SE85:VC) *****		
*	A-6791-926-A	MA-359 COMPLETE BOARD, COMPLETE (SE85:UX) *****		
*	A-6791-928-A	MA-359 COMPLETE BOARD, COMPLETE (SE85:B) *****		
*	A-6791-929-A	MA-359 COMPLETE BOARD, COMPLETE (SE85:NP) *****		
*	A-6791-960-A	MA-359 COMPLETE BOARD, COMPLETE (SF99:EN) *****		
*	A-6791-961-A	MA-359 COMPLETE BOARD, COMPLETE (SF99:VC) *****		
*	A-6791-962-A	MA-359 COMPLETE BOARD, COMPLETE (SF99:NP) *****		
*	A-6791-963-A	MA-359 COMPLETE BOARD, COMPLETE (SF99:B) *****		
*	A-6791-964-A	MA-359 COMPLETE BOARD, COMPLETE (SF99:UX) ***** (Ref.No.:1000 Series)		
*	3-960-273-01	SPACER, TOP END		
*	3-960-274-01	SPACER, LED		
< CAPACITOR >				
C001	1-163-031-11	CERAMIC CHIP	0.01uF	50V
C002	1-126-933-11	ELECT	100uF	20% 16V
C003	1-164-346-11	CERAMIC CHIP	1uF	16V
C004	1-126-963-11	ELECT	4.7uF	20% 50V
C006	1-110-501-11	CERAMIC CHIP	0.33uF	10% 16V

Ref. No.	Part No.	Description	Remarks	Ref. No.	Part No.	Description	Remarks
C007	1-126-964-11	ELECT	10uF 20% 50V	C221	1-164-004-11	CERAMIC CHIP	0.1uF 10% 25V
C008	1-163-031-11	CERAMIC CHIP	0.01uF 50V	C222	1-109-982-11	CERAMIC CHIP	1uF 10% 10V
C009	1-163-021-91	CERAMIC CHIP	0.01uF 10% 50V	C223	1-163-038-91	CERAMIC CHIP	0.1uF 25V
C010	1-163-021-91	CERAMIC CHIP	0.01uF 10% 50V	C224	1-163-021-91	CERAMIC CHIP	0.01uF 10% 50V
C100	1-128-057-11	ELECT	330uF 20% 6.3V	C225	1-124-589-11	ELECT	47uF 20% 16V
C101	1-163-009-11	CERAMIC CHIP	0.001uF 10% 50V	C226	1-163-038-91	CERAMIC CHIP	0.1uF 25V
C102	1-163-009-11	CERAMIC CHIP	0.001uF 10% 50V	C227	1-124-589-11	ELECT	47uF 20% 16V
C103	1-163-009-11	CERAMIC CHIP	0.001uF 10% 50V	C228	1-163-131-00	CERAMIC CHIP	390PF 5% 50V
C104	1-163-009-11	CERAMIC CHIP	0.001uF 10% 50V	C229	1-164-004-11	CERAMIC CHIP	0.1uF 10% 25V
C105	1-163-021-91	CERAMIC CHIP	0.01uF 10% 50V	C230	1-163-038-91	CERAMIC CHIP	0.1uF 25V
C107	1-130-489-00	MYLAR	0.033uF 5% 50V	C231	1-109-982-11	CERAMIC CHIP	1uF 10% 10V
C108	1-137-441-11	FILM	0.027uF 5% 50V	C232	1-109-982-11	CERAMIC CHIP	1uF 10% 10V
C109	1-126-157-11	ELECT	10uF 20% 16V	C233	1-164-004-11	CERAMIC CHIP	0.1uF 10% 25V
C110	1-164-182-11	CERAMIC CHIP	0.0033uF 10% 50V	C234	1-163-038-91	CERAMIC CHIP	0.01uF 25V
C111	1-163-009-11	CERAMIC CHIP	0.001uF 10% 50V	C235	1-109-982-11	CERAMIC CHIP	1uF 10% 10V
C130	1-163-031-11	CERAMIC CHIP	0.01uF 50V	C236	1-163-243-11	CERAMIC CHIP	47PF 5% 50V
C131	1-163-031-11	CERAMIC CHIP	0.01uF 50V	C237	1-164-004-11	CERAMIC CHIP	0.1uF 10% 25V
C132	1-124-589-11	ELECT	47uF 20% 16V	C238	1-126-157-11	ELECT	10uF 20% 16V
C134	1-164-004-11	CERAMIC CHIP	0.1uF 10% 25V	C239	1-163-243-11	CERAMIC CHIP	47PF 5% 50V
C150	1-163-031-11	CERAMIC CHIP	0.01uF 50V	C240	1-163-243-11	CERAMIC CHIP	47PF 5% 50V
C159	1-163-809-11	CERAMIC CHIP	0.047uF 10% 25V	C241	1-164-004-11	CERAMIC CHIP	0.1uF 10% 25V
C160	1-163-038-91	CERAMIC CHIP	0.1uF 25V	C242	1-164-004-11	CERAMIC CHIP	0.1uF 10% 25V
C161	1-124-589-11	ELECT	47uF 20% 16V	C243	1-163-809-11	CERAMIC CHIP	0.047uF 10% 25V
C162	1-163-251-11	CERAMIC CHIP	100PF 5% 50V	C244	1-163-031-11	CERAMIC CHIP	0.01uF 50V
C164	1-163-229-11	CERAMIC CHIP	12PF 5% 50V	C245	1-163-038-91	CERAMIC CHIP	0.1uF 25V
C165	1-163-229-11	CERAMIC CHIP	12PF 5% 50V	C246	1-163-038-91	CERAMIC CHIP	0.1uF 25V
C166	1-163-038-91	CERAMIC CHIP	0.1uF 25V	C247	1-163-021-91	CERAMIC CHIP	0.01uF 10% 50V
C167	1-124-589-11	ELECT	47uF 20% 16V	C248	1-124-589-11	ELECT	47uF 20% 16V
C170	1-124-589-11	ELECT	47uF 20% 16V	C249	1-126-157-11	ELECT	10uF 20% 16V
C172	1-164-346-11	CERAMIC CHIP	1uF 16V	C250	1-124-589-11	ELECT	47uF 20% 16V
C175	1-128-131-11	ELECT	22uF 20% 50V	C251	1-126-153-11	ELECT	22uF 20% 6.3V
C176	1-128-131-11	ELECT	22uF 20% 50V	C252	1-164-489-11	CERAMIC CHIP	0.22uF 10% 16V
C177	1-128-131-11	ELECT	22uF 20% 50V	C253	1-163-139-00	CERAMIC CHIP	820PF 5% 50V
C178	1-124-257-00	ELECT	2.2uF 20% 50V			(SF99:B/SF90:B(WF),B(SF)/SE85:B)	
C179	1-124-589-11	ELECT	47uF 20% 16V	C254	1-163-021-91	CERAMIC CHIP	0.01uF 10% 50V
				C255	1-163-021-91	CERAMIC CHIP	0.01uF 10% 50V
C200	1-163-021-91	CERAMIC CHIP	0.01uF 10% 50V	C306	1-163-021-91	CERAMIC CHIP	0.01uF 10% 50V
C201	1-109-982-11	CERAMIC CHIP	1uF 10% 10V	C307	1-126-157-11	ELECT	10uF 20% 16V
C202	1-163-021-91	CERAMIC CHIP	0.01uF 10% 50V	C308	1-163-011-11	CERAMIC CHIP	0.0015uF 10% 50V
C203	1-163-809-11	CERAMIC CHIP	0.047uF 10% 25V	C309	1-137-370-11	FILM	0.01uF 5% 50V
C204	1-163-021-91	CERAMIC CHIP	0.01uF 10% 50V	C310	1-126-163-11	ELECT	4.7uF 20% 50V
C205	1-163-239-11	CERAMIC CHIP	33PF 5% 50V	C312	1-124-589-11	ELECT	47uF 20% 16V
C206	1-163-809-11	CERAMIC CHIP	0.047uF 10% 25V	C314	1-126-157-11	ELECT	10uF 20% 16V
C207	1-163-237-11	CERAMIC CHIP	27PF 5% 50V	C315	1-109-982-11	CERAMIC CHIP	1uF 10% 10V
C208	1-109-982-11	CERAMIC CHIP	1uF 10% 10V	C316	1-126-163-11	ELECT	4.7uF 20% 50V
C209	1-163-257-11	CERAMIC CHIP	180PF 5% 50V	C317	1-163-011-11	CERAMIC CHIP	0.0015uF 10% 50V
C210	1-163-239-11	CERAMIC CHIP	33PF 5% 50V	C318	1-126-160-11	ELECT	1uF 20% 50V
C211	1-109-982-11	CERAMIC CHIP	1uF 10% 10V	C320	1-163-038-91	CERAMIC CHIP	0.1uF 25V
C212	1-163-809-11	CERAMIC CHIP	0.047uF 10% 25V	C321	1-124-589-11	ELECT	47uF 20% 16V
C213	1-109-982-11	CERAMIC CHIP	1uF 10% 10V	C322	1-109-982-11	CERAMIC CHIP	1uF 10% 10V
C214	1-164-004-11	CERAMIC CHIP	0.1uF 10% 25V	C323	1-163-251-11	CERAMIC CHIP	100PF 5% 50V
C215	1-163-021-91	CERAMIC CHIP	0.01uF 10% 50V	C360	1-163-037-11	CERAMIC CHIP	0.022uF 10% 25V
C216	1-163-037-11	CERAMIC CHIP	0.022uF 10% 25V	C361	1-163-037-11	CERAMIC CHIP	0.022uF 10% 25V
C217	1-163-021-91	CERAMIC CHIP	0.01uF 10% 50V	C362	1-163-037-11	CERAMIC CHIP	0.022uF 10% 25V
C219	1-163-038-91	CERAMIC CHIP	0.1uF 25V	C363	1-126-933-11	ELECT	100uF 20% 16V
C220	1-124-589-11	ELECT	47uF 20% 16V	C364	1-164-489-11	CERAMIC CHIP	0.22uF 10% 16V

MA-359

Ref. No.	Part No.	Description	Remarks	Ref. No.	Part No.	Description	Remarks
C365	1-126-960-11	ELECT	1uF 20% 50V	C668	1-163-239-11	CERAMIC CHIP 33PF 5% 50V	
C366	1-126-960-11	ELECT	1uF 20% 50V	C669	1-163-239-11	CERAMIC CHIP 33PF 5% 50V	
C367	1-163-016-00	CERAMIC CHIP	0.0039uF 10% 50V	C670	1-164-505-11	CERAMIC CHIP 2.2uF 16V	
C368	1-126-960-11	ELECT	1uF 20% 50V	C671	1-163-229-11	CERAMIC CHIP 12PF 5% 50V	
C369	1-126-967-11	ELECT	47uF 20% 50V	C672	1-163-235-11	CERAMIC CHIP 22PF 5% 50V	
C370	1-126-960-11	ELECT	1uF 20% 50V	C673	1-163-235-11	CERAMIC CHIP 22PF 5% 50V	
C371	1-126-964-11	ELECT	10uF 20% 50V	C674	1-104-664-11	ELECT 47uF 20% 16V	
C372	1-126-960-11	ELECT	1uF 20% 50V	C675	1-163-038-91	CERAMIC CHIP 0.1uF 25V	
C373	1-124-257-00	ELECT	2.2uF 20% 50V	C676	1-163-021-91	CERAMIC CHIP 0.01uF 10% 50V	
C374	1-126-960-11	ELECT	1uF 20% 50V	C677	1-126-960-11	ELECT 1uF 20% 50V	
C375	1-126-960-11	ELECT	1uF 20% 50V	C678	1-126-961-11	ELECT 2.2uF 20% 50V	
C376	1-126-960-11	ELECT	1uF 20% 50V	C678	1-126-960-11	ELECT 1uF 20% 50V	
C377	1-126-964-11	ELECT	10uF 20% 50V				(SE85:UX)
C378	1-126-960-11	ELECT	1uF 20% 50V	C679	1-163-037-11	CERAMIC CHIP 0.022uF 10% 25V	
			(SE85:B,NP,VC/SF90/SF99)	C680	1-163-139-00	CERAMIC CHIP 820PF 5% 50V	
C379	1-126-967-11	ELECT	47uF 20% 50V	C681	1-163-037-11	CERAMIC CHIP 0.022uF 10% 25V	
C380	1-163-016-00	CERAMIC CHIP	0.0039uF 10% 50V	C682	1-109-982-11	CERAMIC CHIP 1uF 10% 10V	
C381	1-126-964-11	ELECT	10uF 20% 50V	C690	1-164-505-11	CERAMIC CHIP 2.2uF 16V	
C382	1-126-160-11	ELECT	1uF 20% 50V	C701	1-126-964-11	ELECT 10uF 20% 50V	
C383	1-126-964-11	ELECT	10uF 20% 50V	C702	1-163-009-11	CERAMIC CHIP 0.001uF 10% 50V	
C384	1-126-964-11	ELECT	10uF 20% 50V	C704	1-126-964-11	ELECT 10uF 20% 50V	
C385	1-126-964-11	ELECT	10uF 20% 50V	C705	1-163-031-11	CERAMIC CHIP 0.01uF 50V	
C386	1-126-964-11	ELECT	10uF 20% 50V	C708	1-104-664-11	ELECT 47uF 20% 16V	
C387	1-164-489-11	CERAMIC CHIP	0.22uF 10% 16V	C709	1-163-031-11	CERAMIC CHIP 0.01uF 50V	
C388	1-124-261-00	ELECT	10uF 20% 50V	C710	1-126-965-11	ELECT 22uF 20% 50V	
			(EXCEPT SE85:VX/SF90:UX(WF),UX(SF),EX/SF99:UX)	C730	1-126-964-11	ELECT 10uF 20% 50V	
C389	1-126-964-11	ELECT	10uF 20% 50V				
			(EXCEPT SE85:VX/SF90:UX(WF),UX(SF),EX/SF99:UX)	C731	1-126-964-11	ELECT 10uF 20% 50V	
C390	1-126-960-11	ELECT	1uF 20% 50V	C752	1-126-933-11	ELECT 100uF 20% 16V	
			(EXCEPT SE85:VX/SF90:UX(WF),UX(SF),EX)	C753	1-164-004-11	CERAMIC CHIP 0.1uF 10% 25V	
C391	1-126-960-11	ELECT	1uF 20% 50V	C755	1-126-935-11	ELECT 470uF 20% 6.3V	
			(EXCEPT SE85:VX/SF90:UX(WF),UX(SF),EX)	C756	1-163-127-00	CERAMIC CHIP 270PF 5% 50V	
C500	1-163-017-00	CERAMIC CHIP	0.0047uF 5% 50V	C850	1-163-038-91	CERAMIC CHIP 0.1uF 25V	
C501	1-163-017-00	CERAMIC CHIP	0.0047uF 5% 50V	C851	1-126-157-11	ELECT 10uF 20% 16V	
C502	1-126-160-11	ELECT	1uF 20% 50V	C852	1-164-161-11	CERAMIC CHIP 0.0022uF 10% 100V	
			(SF99)	C853	1-163-989-11	CERAMIC CHIP 0.033uF 10% 25V	
C503	1-126-160-11	ELECT	1uF 20% 50V	C855	1-164-489-11	CERAMIC CHIP 0.22uF 10% 16V	
			(SF99)	C856	1-163-038-91	CERAMIC CHIP 0.1uF 25V	
C505	1-126-157-11	ELECT	10uF 20% 16V	C890	1-163-021-91	CERAMIC CHIP 0.01uF 10% 50V	
			(SF99)				(SE85/SF90:UX,NP,B,VC)
C506	1-163-021-91	CERAMIC CHIP	0.01uF 10% 50V	C891	1-124-589-11	ELECT 47uF 20% 16V	
			(SF99)				(SE85/SF90:UX,NP,B,VC)
C510	1-163-021-91	CERAMIC CHIP	0.01uF 10% 50V	C892	1-163-038-91	CERAMIC CHIP 0.1uF 25V	
C511	1-104-664-11	ELECT	47uF 20% 16V				(SE85/SF90:UX,NP,B,VC)
C512	1-104-664-11	ELECT	47uF 20% 16V	C893	1-163-038-91	CERAMIC CHIP 0.1uF 25V	
C513	1-126-935-11	ELECT	470uF 20% 6.3V				(SE85/SF90:UX,NP,B,VC)
C520	1-126-935-11	ELECT	470uF 20% 6.3V				
			(SF99)	C894	1-124-589-11	ELECT 47uF 20% 16V	
							(SE85/SF90:UX,NP,B,VC)
C570	1-163-017-00	CERAMIC CHIP	0.0047uF 5% 50V				
C571	1-163-017-00	CERAMIC CHIP	0.0047uF 5% 50V				< CONNECTOR >
C611	1-104-664-11	ELECT	47uF 20% 16V	CN101	1-779-724-11	CONNECTOR, BOARD TO BOARD 5P	
C612	1-164-004-11	CERAMIC CHIP	0.1uF 10% 25V	CN102	1-779-723-11	CONNECTOR, BOARD TO BOARD 9P	
C613	1-126-933-11	ELECT	100uF 20% 16V	CN104	1-766-716-11	CONNECTOR, BOARD TO BOARD 3P	
C615	1-124-589-11	ELECT	47uF 20% 16V	CN164	1-784-512-11	CONNECTOR, FFC/FPC 33P	
C616	1-164-004-11	CERAMIC CHIP	0.1uF 10% 25V	CN165	1-506-469-11	PIN, CONNECTOR 4P	
C660	1-163-239-11	CERAMIC CHIP	33PF 5% 50V				
			(SF99:EN,B/SF90:B(WF),B(SF)/SE85:B)	CN166	1-784-494-11	CONNECTOR, FFC/FPC 15P	
C661	1-104-664-11	ELECT	47uF 20% 16V	CN167	1-506-468-11	PIN, CONNECTOR 3P	
C662	1-163-031-11	CERAMIC CHIP	0.01uF 50V	CN200	1-573-843-11	CONNECTOR, BOARD TO BOARD 11P	
C663	1-164-004-11	CERAMIC CHIP	0.1uF 10% 25V				(SE85:B/SF90:B(WF),B(SF)/SF99)
C665	1-104-664-11	ELECT	47uF 20% 16V	CN203	1-573-852-11	CONNECTOR, BOARD TO BOARD 20P	
				CN204	1-573-843-11	CONNECTOR, BOARD TO BOARD 11P	

Ref. No.	Part No.	Description	Remarks	Ref. No.	Part No.	Description	Remarks
CN500	1-784-415-11	CONNECTOR, SQUARE TYPE 21P				< IC >	
CN500	1-785-636-11	CONNECTOR, SQUARE TYPE 21P					
* CN501	1-568-954-11	PIN, CONNECTOR 5P		IC001	8-759-566-07	IC LA7277M-TLM	
CN570	1-784-415-11	CONNECTOR, SQUARE TYPE 21P		IC100	8-759-702-02	IC NJM062M-TE2	
CN570	1-785-636-11	CONNECTOR, SQUARE TYPE 21P		IC160	8-752-910-08	IC CXP88460-013Q	
				IC161	8-759-481-46	IC LB1943	
CN601	1-784-641-11	CONNECTOR, BOARD TO BOARD 11P		IC200	8-759-547-32	IC LA71560M-MPB (SF99)	
CN602	1-784-641-11	CONNECTOR, BOARD TO BOARD 11P					
		< DIODE >					
D102	8-719-048-26	DIODE GL528V1		IC200	8-759-638-64	IC LA71561M-MPB (SF90,SE85)	
D107	8-719-988-61	DIODE 1SS355TE-17		IC360	8-759-486-63	IC TDA9615H/N1,518	
D108	8-719-200-82	DIODE MPG06D-6052PKG3		IC500	8-759-710-86	IC NJM2233BM(TE2) (SF99)	
D109	8-719-921-42	DIODE MTZJ-T-77-5.1A		IC601	8-759-438-18	IC PQ12RD08	
D131	8-719-200-82	DIODE MPG06D-6052PKG3		IC660	8-759-583-42	IC MB90089PF-G-230-BND-ER (SF99:EN)	
				IC660	8-759-583-43	IC MB90089PF-G-223-BND-ER (SF99:UX,NP,B,VC)	
D132	8-719-200-82	DIODE MPG06D-6052PKG3		IC660	8-759-640-15	IC MB90089PF-G-229-BND-ER (SF90,SE85)	
D508	8-719-070-59	DIODE PDZ6.8B-115		IC661	8-759-164-09	IC LA7218M-TE-R	
D509	8-719-070-59	DIODE PDZ6.8B-115		IC850	8-759-484-61	IC SDA5650X-GEG	
D510	8-719-070-59	DIODE PDZ6.8B-115				< JACK >	
D511	8-719-071-50	DIODE BZA408B-115		J500	1-779-011-11	JACK, PIN 6P (SF99)	
				J500	1-784-414-11	JACK, PIN 2P (SF90,SE85)	
D512	8-719-072-68	DIODE PDZ13B-115		J890	1-779-013-11	JACK, MINIATURE (SE85/SF99:UX,NP,B,VC)	
D513	8-719-071-50	DIODE BZA408B-115				< JUMPER RESISTOR >	
D515	8-719-071-50	DIODE BZA408B-115		JR001	1-216-295-91	SHORT 0 (SF90/SF99)	
D516	8-719-071-50	DIODE BZA408B-115		JR002	1-216-295-91	SHORT 0	
D517	8-719-071-50	DIODE BZA408B-115 (SF99)		JR003	1-216-295-91	SHORT 0	
				JR004	1-216-295-91	SHORT 0	
D544	8-719-070-59	DIODE PDZ6.8B-115		JR005	1-216-295-91	SHORT 0	
D570	8-719-070-59	DIODE PDZ6.8B-115		JR006	1-216-295-91	SHORT 0 (SF90/SF99)	
D590	8-719-988-61	DIODE 1SS355TE-17		JR007	1-216-295-91	SHORT 0	
D603	8-719-200-82	DIODE MPG06D-6052PKG3		JR008	1-216-295-91	SHORT 0	
D604	8-719-070-56	DIODE PDZ5.1B-115		JR009	1-216-295-91	SHORT 0	
				JR010	1-216-295-91	SHORT 0	
D605	8-719-988-61	DIODE 1SS355TE-17		JR011	1-216-295-91	SHORT 0	
D660	8-719-988-61	DIODE 1SS355TE-17		JR012	1-216-295-91	SHORT 0	
D702	8-719-982-26	DIODE MTZJ-T-77-33		JR013	1-216-295-91	SHORT 0	
D750	8-719-200-82	DIODE MPG06D-6052PKG3		JR014	1-216-295-91	SHORT 0	
D800	8-719-988-61	DIODE 1SS355TE-17		JR015	1-216-295-91	SHORT 0 (EXCEPT SF90:NP)	
				JR016	1-216-295-91	SHORT 0 (EXCEPT SF90:NP)	
D890	8-719-070-59	DIODE PDZ6.8B-115 (SE85/SF90:UX,NP,B,VC)		JR017	1-216-295-91	SHORT 0 (EXCEPT SF90:NP)	
D891	8-719-070-59	DIODE PDZ6.8B-115 (SE85/SF90:UX,NP,B,VC)		JR018	1-216-295-91	SHORT 0 (EXCEPT SF90:NP)	
D892	8-719-070-59	DIODE PDZ6.8B-115 (SE85/SF90:UX,NP,B,VC)		JR019	1-216-295-91	SHORT 0 (EXCEPT SF90:NP)	
		< FILTER >		JR020	1-216-295-91	SHORT 0 (EXCEPT SF90:NP)	
FL500	1-236-163-11	ENCAPSULATED COMPONENT		JR021	1-216-296-91	SHORT 0 (EXCEPT SF90:NP)	
FL501	1-236-163-11	ENCAPSULATED COMPONENT		JR022	1-216-295-91	SHORT 0 (EXCEPT SE85/SF99:NP)	
FL502	1-236-163-11	ENCAPSULATED COMPONENT		JR023	1-216-295-91	SHORT 0 (EXCEPT SE85/SF90:VC(SF)/SF99:NP)	
FL503	1-236-163-11	ENCAPSULATED COMPONENT		JR024	1-216-295-91	SHORT 0 (EXCEPT SE85/SF90:VC(SF)/SF99:NP)	
FL504	1-236-163-11	ENCAPSULATED COMPONENT		JR025	1-216-295-91	SHORT 0 (EXCEPT SF90:VC(SF)/SF99:NP)	
				JR026	1-216-295-91	SHORT 0 (EXCEPT SF90:VC(SF)/SF99:NP)	
FL505	1-236-163-11	ENCAPSULATED COMPONENT		JR027	1-216-295-91	SHORT 0 (EXCEPT SF90:VC(SF)/SF99:NP)	
FL506	1-236-163-11	ENCAPSULATED COMPONENT (SF99)		JR028	1-216-295-91	SHORT 0 (EXCEPT SF90:VC(SF)/SF99:NP)	
FL507	1-236-163-11	ENCAPSULATED COMPONENT (SF99)		JR201	1-216-296-91	SHORT 0 (EXCEPT SF90:VC(SF)/SF99:NP)	
FL570	1-236-163-11	ENCAPSULATED COMPONENT		JR202	1-216-296-91	SHORT 0 (EXCEPT SF90:VC(SF)/SF99:NP)	
FL571	1-236-163-11	ENCAPSULATED COMPONENT					
FL572	1-236-163-11	ENCAPSULATED COMPONENT (EXCEPT SE85:VX/SF90:UX(WF),UX(SF),EX/SF99:UX)					
FL573	1-236-163-11	ENCAPSULATED COMPONENT (EXCEPT SE85:VX/SF90:UX(WF),UX(SF),EX/SF99:UX)					

MA-359

Ref. No.	Part No.	Description	Remarks	Ref. No.	Part No.	Description	Remarks
JR203	1-216-296-91	SHORT	0 (EXCEPT SF90:VC(SF)/SF99:NP)	JR233	1-216-296-91	SHORT	0 (EXCEPT SF90:VC(SF)/SF99:NP)
JR204	1-216-296-91	SHORT	0 (EXCEPT SF90:VC(SF)/SF99:NP)	JR234	1-216-296-91	SHORT	0 (EXCEPT SF90:VC(SF)/SF99:NP)
JR205	1-216-296-91	SHORT	0 (EXCEPT SF90:VC(SF)/SF99:NP)	JR235	1-216-296-91	SHORT	0 (EXCEPT SF90:VC(SF)/SF99:NP)
JR206	1-216-296-91	SHORT	0 (EXCEPT SF90:VC(SF)/SF99:NP)	JR236	1-216-296-91	SHORT	0 (EXCEPT SF90:VC(SF)/SF99:NP)
JR207	1-216-296-91	SHORT	0 (EXCEPT SF90:VC(SF)/SF99:NP)	JR237	1-216-296-91	SHORT	0 (EXCEPT SF90:VC(SF)/SF99:NP)
JR208	1-216-296-91	SHORT	0 (EXCEPT SF90:VC(SF)/SF99:NP)	JR238	1-216-296-91	SHORT	0 (EXCEPT SF90:VC(SF)/SF99:NP)
JR209	1-216-296-91	SHORT	0 (EXCEPT SF90:VC(SF)/SF99:NP)	JR239	1-216-296-91	SHORT	0 (EXCEPT SF90:VC(SF)/SF99:NP)
JR210	1-216-296-91	SHORT	0 (EXCEPT SF90:VC(SF)/SF99:NP)	JR240	1-216-296-91	SHORT	0 (EXCEPT SF90:VC(SF)/SF99:NP)
JR211	1-216-296-91	SHORT	0 (EXCEPT SF90:VC(SF)/SF99:NP)	JR241	1-216-296-91	SHORT	0 (EXCEPT SF90:VC(SF)/SF99:NP)
JR212	1-216-296-91	SHORT	0 (EXCEPT SF90:VC(SF)/SF99:NP)	JR243	1-216-296-91	SHORT	0 (EXCEPT SF90:VC(SF)/SF99:NP)
JR213	1-216-296-91	SHORT	0 (EXCEPT SF90:VC(SF)/SF99:NP)	JR244	1-216-296-91	SHORT	0 (EXCEPT SF90:VC(SF)/SF99:NP)
JR214	1-216-296-91	SHORT	0 (EXCEPT SF90:VC(SF)/SF99:NP)	JR245	1-216-296-91	SHORT	0 (EXCEPT SF90:VC(SF)/SF99:NP)
JR215	1-216-296-91	SHORT	0 (EXCEPT SF90:VC(SF)/SF99:NP)	JR246	1-216-296-91	SHORT	0 (EXCEPT SF90:VC(SF)/SF99:NP)
JR216	1-216-296-91	SHORT	0 (EXCEPT SF90:VC(SF)/SF99:NP)	JR247	1-216-296-91	SHORT	0 (EXCEPT SF90:VC(SF)/SF99:NP)
JR217	1-216-296-91	SHORT	0 (EXCEPT SF90:VC(SF)/SF99:NP)	JR248	1-216-296-91	SHORT	0 (EXCEPT SF90:VC(SF)/SF99:NP)
JR218	1-216-296-91	SHORT	0 (EXCEPT SF90:VC(SF)/SF99:NP)	JR249	1-216-296-91	SHORT	0 (EXCEPT SF90:VC(SF)/SF99:NP)
JR219	1-216-296-91	SHORT	0 (EXCEPT SF90:VC(SF)/SF99:NP)	JR250	1-216-296-91	SHORT	0 (EXCEPT SF90:VC(SF)/SF99:NP)
JR220	1-216-296-91	SHORT	0 (EXCEPT SF90:VC(SF)/SF99:NP)	JR251	1-216-296-91	SHORT	0 (EXCEPT SF90:VC(SF)/SF99:NP)
JR221	1-216-296-91	SHORT	0 (EXCEPT SF90:VC(SF)/SF99:NP)	JR252	1-216-296-91	SHORT	0 (EXCEPT SF90:VC(SF))
JR222	1-216-296-91	SHORT	0 (EXCEPT SF90:VC(SF)/SF99:NP)	JR253	1-216-296-91	SHORT	0 (EXCEPT SF90:VC(SF))
JR223	1-216-296-91	SHORT	0 (EXCEPT SF90:VC(SF)/SF99:NP)	JR254	1-216-295-91	SHORT	0 (EXCEPT SF90:VC(SF))
JR224	1-216-296-91	SHORT	0 (EXCEPT SF90:VC(SF)/SF99:NP)	JR255	1-216-295-91	SHORT	0 (EXCEPT SF90:VC(SF))
JR225	1-216-296-91	SHORT	0 (EXCEPT SF90:VC(SF)/SF99:NP)	JR256	1-216-295-91	SHORT	0 (EXCEPT SF90:VC(SF))
JR226	1-216-296-91	SHORT	0 (EXCEPT SF90:VC(SF)/SF99:NP)	JR257	1-216-295-91	SHORT	0 (EXCEPT SF90:VC(SF))
JR227	1-216-296-91	SHORT	0 (EXCEPT SF90:VC(SF)/SF99:NP)	JR258	1-216-295-91	SHORT	0 (EXCEPT SF90:VC(SF))
JR228	1-216-296-91	SHORT	0 (EXCEPT SF90:VC(SF)/SF99:NP)	JR259	1-216-296-91	SHORT	0 (EXCEPT SF90:VC(SF))
JR229	1-216-296-91	SHORT	0 (EXCEPT SF90:VC(SF)/SF99:NP)	JS200	1-216-295-91	SHORT	0 (SF99:UX,EN,NP,VC)
JR230	1-216-296-91	SHORT	0 (EXCEPT SF90:VC(SF)/SF99:NP)	JS201	1-216-295-91	SHORT	0 (SF99:UX,EN,NP,VC)
JR231	1-216-296-91	SHORT	0 (EXCEPT SF90:VC(SF)/SF99:NP)	JS204	1-216-295-91	SHORT	0 (SF99:B/SF90/SE85)
JR232	1-216-296-91	SHORT	0 (EXCEPT SF90:VC(SF)/SF99:NP)	JS210	1-216-295-91	SHORT	0 (SF99:B/SF90:B(WF),B(SF)/SE85:B)
				JS211	1-216-295-91	SHORT	0 (SF99:B/SF90:B(WF),B(SF)/SE85:B)
				JS212	1-216-295-91	SHORT	0 (SF99:UX,EN,NP,VC)
				JS213	1-216-295-91	SHORT	0 (SF90:B(WF),B(SF))
				JS217	1-216-296-91	SHORT	0 (SF99:UX,EN,NP,VC)
				JS218	1-216-295-91	SHORT	0 (SF99:B/SF90:B(WF),B(SF)/SE85:B)
				JS219	1-216-295-91	SHORT	0 (SF99:B/SF90:B(WF),B(SF)/SE85:B)
				JS220	1-216-295-91	SHORT	0 (SF99:B/SF90/SE85)
				JS500	1-216-295-91	SHORT	0 (SF90/SE85)
				JS591	1-216-295-91	SHORT	0
				JS605	1-216-296-91	SHORT	0

Ref. No.	Part No.	Description	Remarks	Ref. No.	Part No.	Description	Remarks
JS705	1-216-295-91	SHORT	0	Q204	8-729-043-29	TRANSISTOR PDTC144EK-115	(SF99:B/SF90:B(WF),B(SF)/SE85:B)
JS805	1-216-295-91	SHORT	0	Q205	8-729-043-32	TRANSISTOR PDTA114EK-115	(SF99:B/SF90:B(WF),B(SF)/SE85:B)
		< COIL >		Q501	8-729-043-32	TRANSISTOR PDTA114EK-115	(EXCEPT SF99:EN)
L001	1-414-934-21	INDUCTOR	10uH (SF99:UX,EN,NP,VC)	Q502	8-729-043-29	TRANSISTOR PDTC144EK-115	(EXCEPT SF99:EN)
L161	1-414-934-21	INDUCTOR	10uH	Q510	8-729-216-22	TRANSISTOR 2PB709AR-115	(EXCEPT SF90:UX(SF)/SF99:EN)
L163	1-414-934-21	INDUCTOR	10uH	Q520	8-729-216-22	TRANSISTOR 2PB709AR-115	(SF99:UX,NP,B,VC)
L200	1-414-946-21	INDUCTOR	39uH	Q540	8-729-216-22	TRANSISTOR 2PB709AR-115	(EXCEPT SE85:VX/SF90:UX(WF),UX(SF),EX/SF99:UX)
L201	1-414-940-21	INDUCTOR	100uH	Q541	8-729-216-22	TRANSISTOR 2PB709AR-115	(EXCEPT SE85:VX/SF90:UX(WF),UX(SF),EX/SF99:UX)
L202	1-414-934-21	INDUCTOR	10uH	Q590	8-729-422-33	TRANSISTOR 2PD601AR-115	(EXCEPT SF90:UX(SF)/SF99:EN)
L203	1-414-934-21	INDUCTOR	10uH	Q591	8-729-422-33	TRANSISTOR 2PD601AR-115	(EXCEPT SF90:UX(SF)/SF99:EN)
L204	1-414-934-21	INDUCTOR	10uH	Q592	8-729-216-22	TRANSISTOR 2PB709AR-115	(EXCEPT SF90:UX(SF)/SF99:EN)
L205	1-414-934-21	INDUCTOR	10uH	Q607	8-729-804-41	TRANSISTOR 2SB1122-ST-TD	(EXCEPT SF90:UX(SF)/SF99:EN)
L206	1-414-938-21	INDUCTOR	47uH	Q608	8-729-043-29	TRANSISTOR PDTC144EK-115	(EXCEPT SF90:UX(SF)/SF99:EN)
			(SF99:B/SF90:B(WF),B(SF)/SE85:B)	Q609	8-729-804-41	TRANSISTOR 2SB1122-ST-TD	(EXCEPT SF90:UX(SF)/SF99:EN)
L300	1-414-940-21	INDUCTOR	100uH	Q610	8-729-043-29	TRANSISTOR PDTC144EK-115	(EXCEPT SF90:UX(SF)/SF99:EN)
L360	1-414-940-21	INDUCTOR	100uH	Q611	8-729-216-22	TRANSISTOR 2PB709AR-115	(EXCEPT SF90:B(WF),UX(SF)/SF99:EN)
L510	1-414-940-21	INDUCTOR	100uH	Q612	8-729-043-29	TRANSISTOR PDTC144EK-115	(EXCEPT SF90:B(WF),UX(SF)/SF99:EN)
L600	1-414-940-21	INDUCTOR	100uH	Q613	8-729-106-68	TRANSISTOR 2SD1664-T100-R	(EXCEPT SF90:B(WF),UX(SF)/SF99:EN)
L660	1-414-186-31	INDUCTOR	33uH	Q660	8-729-043-29	TRANSISTOR PDTC144EK-115	(SF99:EN,B/SF90:B(WF),B(SF)/SE85:B)
			(SF99:EN,B/SF90:B(WF),B(SF)/SE85:B)	Q661	8-729-422-33	TRANSISTOR 2PD601AR-115	(SF99:EN,B/SF90:B(WF),B(SF)/SE85:B)
L662	1-414-940-21	INDUCTOR	100uH	Q662	8-729-216-22	TRANSISTOR 2PB709AR-115	(EXCEPT SF90:B(WF),UX(SF)/SF99:EN)
L663	1-414-940-21	INDUCTOR	100uH	Q663	8-729-216-22	TRANSISTOR 2PB709AR-115	(EXCEPT SF90:B(WF),UX(SF)/SF99:EN)
L664	1-412-470-21	INDUCTOR	22uH	Q664	8-729-216-22	TRANSISTOR 2PB709AR-115	(EXCEPT SF90:B(WF),UX(SF)/SF99:EN)
L701	1-414-930-21	INDUCTOR	2.2uH	Q751	8-729-043-29	TRANSISTOR PDTC144EK-115	(EXCEPT SF90:B(WF),UX(SF)/SF99:EN)
L750	1-414-930-21	INDUCTOR	2.2uH	Q752	8-729-216-22	TRANSISTOR 2PB709AR-115	(EXCEPT SF90:B(WF),UX(SF)/SF99:EN)
L755	1-414-940-21	INDUCTOR	100uH	Q780	8-729-043-29	TRANSISTOR PDTC144EK-115	(EXCEPT SF90:B(WF),UX(SF)/SF99:EN)
L890	1-408-970-21	INDUCTOR	10uH	Q781	8-729-804-41	TRANSISTOR 2SB1122-ST-TD	(EXCEPT SF90:B(WF),UX(SF)/SF99:EN)
			(SF99:UX,NP,B,VC/SE85)	Q800	8-729-216-22	TRANSISTOR 2PB709AR-115	(EXCEPT SF90:B(WF),UX(SF)/SF99:EN)
		< PHOTO INTERRUPTER >		Q801	8-729-422-33	TRANSISTOR 2PD601AR-115	(EXCEPT SF90:B(WF),UX(SF)/SF99:EN)
PH100	8-749-015-86	PHOTO INTERRUPTER GP3S120S		Q802	8-729-422-33	TRANSISTOR 2PD601AR-115	(EXCEPT SF90:B(WF),UX(SF)/SF99:EN)
PH101	8-749-015-86	PHOTO INTERRUPTER GP3S120S	(EXCEPT SF99:EN)				
		< IC LINK >					
△ PS601	1-801-552-21	PROTECTOR, MODUL (EXCEPT SF99:EN)					
△ PS602	1-801-552-21	PROTECTOR, MODUL (EXCEPT SF99:EN)					
△ PS603	1-801-552-21	PROTECTOR, MODUL (EXCEPT SF99:EN)					
		< TRANSISTOR >					
Q100	8-729-043-84	TRANSISTOR	PT380F3 (EXCEPT SF99:EN)				
Q101	8-729-043-84	TRANSISTOR	PT380F3 (EXCEPT SF99:EN)				
Q102	8-729-281-53	TRANSISTOR	2SC1815GR-TPE2				
			(EXCEPT SF99:EN)				
Q103	8-729-043-29	TRANSISTOR	PDTC144EK-115				
			(EXCEPT SF99:EN)				
Q104	8-729-043-29	TRANSISTOR	PDTC144EK-115				
			(EXCEPT SF99:EN)				
Q105	8-729-230-49	TRANSISTOR	2SC2712Y-TE85L				
			(EXCEPT SF99:EN)				
Q200	8-729-422-33	TRANSISTOR	2PD601AR-115				
			(EXCEPT SF99:EN)				
Q201	8-729-422-33	TRANSISTOR	2PD601AR-115				
			(EXCEPT SF99:EN)				
Q202	8-729-422-33	TRANSISTOR	2PD601AR-115				
			(EXCEPT SF99:EN)				
Q203	8-729-216-22	TRANSISTOR	2PB709AR-115				
			(EXCEPT SF99:EN)				

<p>Note : The components identified by mark △ or dotted line with mark △ are critical for safety. Replace only with part number specified.</p>	<p>Note : Les composants identifiés par une marque △ sont critiques pour la sécurité. Ne les remplacer que par une pièce portant le numéro spécifié.</p>
---	---

MA-359

Ref. No.	Part No.	Description	Remarks	Ref. No.	Part No.	Description	Remarks
Q803	8-729-422-33	TRANSISTOR 2PD601AR-115 (EXCEPT SF90:B(WF),UX(SF)/SF99:EN)		R134	1-216-089-91	RES,CHIP 47K 5% 1/10W (EXCEPT SF90:B(WF),UX(SF))	
Q804	8-729-043-29	TRANSISTOR PDTC144EK-115 (EXCEPT SF90:B(WF),UX(SF)/SF99:EN)		R135	1-216-073-00	METAL CHIP 10K 5% 1/10W (EXCEPT SF90:B(WF),UX(SF))	
Q850	8-729-216-22	TRANSISTOR 2PB709AR-115 (EXCEPT SF90:B(WF),UX(SF)/SF99:EN)		R136	1-216-073-00	METAL CHIP 10K 5% 1/10W (EXCEPT SF90:B(WF),UX(SF))	
Q891	8-729-422-33	TRANSISTOR 2PD601AR-115 (SF99:UX,NP,B,VC/SE85)		R160	1-216-073-00	METAL CHIP 10K 5% 1/10W (EXCEPT SF90:B(WF),UX(SF))	
Q892	8-729-140-75	TRANSISTOR 2SD999-T1CL (SF99:UX,NP,B,VC/SE85)		R161	1-216-073-00	METAL CHIP 10K 5% 1/10W (EXCEPT SF90:B(WF),UX(SF))	
Q893	8-729-422-33	TRANSISTOR 2PD601AR-115 (SF99:UX,NP,B,VC/SE85)		R162	1-216-089-91	RES,CHIP 47K 5% 1/10W (EXCEPT SF90:B(WF),UX(SF))	
		< RESISTOR >		R163	1-216-073-00	METAL CHIP 10K 5% 1/10W (EXCEPT SF90:B(WF),UX(SF))	
R001	1-208-806-11	RES,CHIP 10K 0.50% 1/10W (EXCEPT SF90:B(WF),UX(SF)/SF99:EN)		R164	1-216-089-91	RES,CHIP 47K 5% 1/10W (EXCEPT SF90:B(WF),UX(SF))	
R002	1-216-049-91	RES,CHIP 1K 5% 1/10W (EXCEPT SF90:B(WF),UX(SF)/SF99:EN)		R165	1-216-041-00	METAL CHIP 470 5% 1/10W (EXCEPT SF90:B(WF),UX(SF))	
R003	1-216-049-91	RES,CHIP 1K 5% 1/10W (EXCEPT SF90:B(WF),UX(SF)/SF99:EN)		R166	1-216-041-00	METAL CHIP 470 5% 1/10W (EXCEPT SF90:B(WF),UX(SF))	
R004	1-216-071-00	METAL CHIP 8.2K 5% 1/10W (EXCEPT SF90:B(WF),UX(SF)/SF99:EN)		R167	1-216-049-91	RES,CHIP 1K 5% 1/10W (EXCEPT SF90:B(WF),UX(SF))	
R005	1-216-049-91	RES,CHIP 1K 5% 1/10W (EXCEPT SF90:B(WF),UX(SF)/SF99:EN)		R168	1-216-295-91	SHORT 0 (EXCEPT SF90:B(WF),UX(SF))	
R006	1-216-041-00	METAL CHIP 470 5% 1/10W (EXCEPT SE85/SF90:B(WF),UX(SF)/SF99:EN)		R169	1-216-295-91	SHORT 0 (EXCEPT SF90:B(WF),UX(SF))	
R100	1-249-400-11	CARBON 39 5% 1/4W F (EXCEPT SF90:B(WF),UX(SF)/SF99:EN)		R170	1-216-295-91	SHORT 0 (EXCEPT SF90:B(WF))	
R101	1-249-400-11	CARBON 39 5% 1/4W F (EXCEPT SF90:B(WF),UX(SF)/SF99:EN)		R171	1-216-295-91	SHORT 0 (EXCEPT SF90:B(WF))	
R102	1-216-057-00	METAL CHIP 2.2K 5% 1/10W (EXCEPT SF90:B(WF),UX(SF)/SF99:EN)		R172	1-216-073-00	METAL CHIP 10K 5% 1/10W (EXCEPT SF90:B(WF))	
R103	1-216-085-00	METAL CHIP 33K 5% 1/10W (EXCEPT SF90:B(WF),UX(SF)/SF99:EN)		R173	1-216-073-00	METAL CHIP 10K 5% 1/10W (EXCEPT SF90:B(WF))	
R104	1-216-085-00	METAL CHIP 33K 5% 1/10W (EXCEPT SF90:B(WF),UX(SF)/SF99:EN)		R174	1-216-041-00	METAL CHIP 470 5% 1/10W (EXCEPT SF90:B(WF))	
R105	1-249-413-11	CARBON 470 5% 1/4W F (EXCEPT SF90:B(WF),UX(SF)/SF99:EN)		R175	1-216-049-91	RES,CHIP 1K 5% 1/10W (EXCEPT SF90:B(WF))	
R106	1-216-077-91	RES,CHIP 15K 5% 1/10W (EXCEPT SF90:B(WF),UX(SF)/SF99:EN)		R176	1-216-073-00	METAL CHIP 10K 5% 1/10W (EXCEPT SF90:B(WF))	
R107	1-216-077-91	RES,CHIP 15K 5% 1/10W (EXCEPT SF90:B(WF),UX(SF)/SF99:EN)		R177	1-216-057-00	METAL CHIP 2.2K 5% 1/10W (EXCEPT SF90:B(WF))	
R109	1-216-057-00	METAL CHIP 2.2K 5% 1/10W (EXCEPT SF90:B(WF),UX(SF)/SF99:EN)		R178	1-216-295-91	SHORT 0 (EXCEPT SF90:B(WF))	
R110	1-216-057-00	METAL CHIP 2.2K 5% 1/10W (EXCEPT SF90:B(WF),UX(SF)/SF99:EN)		R179	1-216-069-00	METAL CHIP 6.8K 5% 1/10W (SF99)	
R111	1-216-103-00	METAL CHIP 180K 5% 1/10W (EXCEPT SF90:B(WF),UX(SF)/SF99:EN)		R181	1-216-097-91	RES,CHIP 100K 5% 1/10W	
R112	1-216-689-11	METAL CHIP 39K 0.5% 1/10W (EXCEPT SF90:B(WF),UX(SF)/SF99:EN)		R182	1-216-017-91	RES,CHIP 47 5% 1/10W	
R113	1-208-806-11	RES,CHIP 10K 0.50% 1/10W (EXCEPT SF90:B(WF),UX(SF)/SF99:EN)		R183	1-216-041-00	METAL CHIP 470 5% 1/10W	
R114	1-208-806-11	RES,CHIP 10K 0.50% 1/10W (EXCEPT SF90:B(WF),UX(SF)/SF99:EN)		R184	1-216-041-00	METAL CHIP 470 5% 1/10W	
R119	1-216-065-91	RES,CHIP 4.7K 5% 1/10W (EXCEPT SF90:B(WF),UX(SF))		R200	1-216-073-00	METAL CHIP 10K 5% 1/10W (EXCEPT SF90:B(WF))	
R120	1-216-065-91	RES,CHIP 4.7K 5% 1/10W (EXCEPT SF90:B(WF),UX(SF))		R203	1-216-055-00	METAL CHIP 1.8K 5% 1/10W (EXCEPT SF90:B(WF))	
R130	1-216-085-00	METAL CHIP 33K 5% 1/10W (EXCEPT SF90:B(WF),UX(SF))		R204	1-216-037-00	METAL CHIP 330 5% 1/10W (EXCEPT SF90:B(WF))	
R131	1-216-085-00	METAL CHIP 33K 5% 1/10W (EXCEPT SF90:B(WF),UX(SF))		R205	1-216-037-00	METAL CHIP 330 5% 1/10W (EXCEPT SF90:B(WF))	
R133	1-216-073-00	METAL CHIP 10K 5% 1/10W (EXCEPT SF90:B(WF),UX(SF))		R206	1-216-045-00	METAL CHIP 680 5% 1/10W (EXCEPT SF90:B(WF))	
				R207	1-216-059-00	METAL CHIP 2.7K 5% 1/10W (EXCEPT SF90:B(WF))	
				R208	1-216-065-91	RES,CHIP 4.7K 5% 1/10W (EXCEPT SF90:B(WF))	
				R209	1-216-055-00	METAL CHIP 1.8K 5% 1/10W (EXCEPT SF90:B(WF))	

Ref. No.	Part No.	Description	Remarks	Ref. No.	Part No.	Description	Remarks
R210	1-216-051-00	METAL CHIP	1.2K 5% 1/10W (EXCEPT SF90:B(WF))	R318	1-216-075-00	METAL CHIP	12K 5% 1/10W (EXCEPT SF90:B(WF))
R211	1-216-071-00	METAL CHIP	8.2K 5% 1/10W (EXCEPT SF90:B(WF))	R319	1-216-085-00	METAL CHIP	33K 5% 1/10W (EXCEPT SF90:B(WF))
R212	1-216-051-00	METAL CHIP	1.2K 5% 1/10W (EXCEPT SF90:B(WF))	R320	1-216-129-00	METAL CHIP	2.2M 5% 1/10W (EXCEPT SF90:B(WF))
R213	1-216-049-91	RES,CHIP	1K 5% 1/10W (EXCEPT SF90:B(WF))	R321	1-216-051-00	METAL CHIP	1.2K 5% 1/10W (EXCEPT SF90:B(WF))
R214	1-216-049-91	RES,CHIP	1K 5% 1/10W (EXCEPT SF90:B(WF))	R322	1-216-079-00	METAL CHIP	18K 5% 1/10W (EXCEPT SF90:B(WF))
R215	1-216-025-91	RES,CHIP	100 5% 1/10W (EXCEPT SF90:B(WF))	R323	1-216-069-00	METAL CHIP	6.8K 5% 1/10W (EXCEPT SF90:B(WF))
R216	1-216-105-91	RES,CHIP	220K 5% 1/10W (EXCEPT SF90:B(WF))	R324	1-216-085-00	METAL CHIP	33K 5% 1/10W (EXCEPT SF90:B(WF))
R217	1-216-025-91	RES,CHIP	100 5% 1/10W (EXCEPT SF90:B(WF))	R327	1-216-067-00	METAL CHIP	5.6K 5% 1/10W (EXCEPT SF90:B(WF))
R218	1-216-025-91	RES,CHIP	100 5% 1/10W (EXCEPT SF90:B(WF))	R328	1-216-093-91	RES,CHIP	68K 5% 1/10W (EXCEPT SF90:B(WF))
R219	1-216-025-91	RES,CHIP	100 5% 1/10W (EXCEPT SF90:B(WF))	R329	1-249-408-11	CARBON	180 5% 1/4W F (EXCEPT SF90:B(WF))
R220	1-216-045-00	METAL CHIP	680 5% 1/10W (EXCEPT SF90:B(WF))	R360	1-216-083-00	METAL CHIP	27K 5% 1/10W (EXCEPT SF90:B(WF))
R221	1-216-017-91	RES,CHIP	47 5% 1/10W (EXCEPT SF90:B(WF))	R361	1-216-073-00	METAL CHIP	10K 5% 1/10W (EXCEPT SF90:B(WF))
R222	1-216-017-91	RES,CHIP	47 5% 1/10W (EXCEPT SF90:B(WF))	R362	1-216-049-91	RES,CHIP	1K 5% 1/10W (EXCEPT SF90:B(WF))
R223	1-216-017-91	RES,CHIP	47 5% 1/10W (EXCEPT SF90:B(WF))	R363	1-216-049-91	RES,CHIP	1K 5% 1/10W (EXCEPT SF90:B(WF))
R224	1-216-057-00	METAL CHIP	2.2K 5% 1/10W (EXCEPT SF90:B(WF))	R364	1-216-091-00	METAL CHIP	56K 5% 1/10W (EXCEPT SF90:B(WF))
R225	1-216-057-00	METAL CHIP	2.2K 5% 1/10W (EXCEPT SF90:B(WF))	R365	1-216-065-91	RES,CHIP	4.7K 5% 1/10W (EXCEPT SF90:B(WF))
R226	1-216-055-00	METAL CHIP	1.8K 5% 1/10W (EXCEPT SF90:B(WF))	R366	1-216-025-91	RES,CHIP	100 5% 1/10W (EXCEPT SF90:B(WF))
R227	1-216-295-91	SHORT	0 (EXCEPT SF90:B(WF))	R367	1-216-025-91	RES,CHIP	100 5% 1/10W (EXCEPT SF90:B(WF))
R228	1-216-295-91	SHORT	0 (SF99:B/SF90:B(WF),B(SF)/SE85:B)	R368	1-216-079-00	METAL CHIP	18K 5% 1/10W (EXCEPT SF90:B(WF))
R232	1-216-097-91	RES,CHIP	100K 5% 1/10W (EXCEPT SF90:B(WF))	R369	1-208-820-11	RES,CHIP	39K 0.50% 1/10W (EXCEPT SF90:B(WF))
R250	1-216-077-91	RES,CHIP	15K 5% 1/10W (EXCEPT SF90:B(WF))	R370	1-216-079-00	METAL CHIP	18K 5% 1/10W (EXCEPT SF90:B(WF))
R251	1-216-073-00	METAL CHIP	10K 5% 1/10W (SF99:B/SF90:B(WF),B(SF)/SE85:B)	R371	1-216-079-00	METAL CHIP	18K 5% 1/10W (EXCEPT SF90:B(WF))
R303	1-216-063-91	RES,CHIP	3.9K 5% 1/10W (EXCEPT SF90:B(WF))	R372	1-216-079-00	METAL CHIP	18K 5% 1/10W (EXCEPT SF90:B(WF))
R305	1-216-071-00	METAL CHIP	8.2K 5% 1/10W (EXCEPT SF90:B(WF))	R373	1-216-065-91	RES,CHIP	4.7K 5% 1/10W (EXCEPT SF90:B(WF))
R306	1-216-053-00	METAL CHIP	1.5K 5% 1/10W (EXCEPT SF90:B(WF))	R374	1-216-091-00	METAL CHIP	56K 5% 1/10W (EXCEPT SF90:B(WF))
R311	1-216-035-00	METAL CHIP	270 5% 1/10W (EXCEPT SF90:B(WF))	R375	1-216-133-00	METAL CHIP	3.3M 5% 1/10W (EXCEPT SF90:B(WF))
R312	1-216-109-00	METAL CHIP	330K 5% 1/10W (EXCEPT SF90:B(WF))	R376	1-216-079-00	METAL CHIP	18K 5% 1/10W (SF90:B(WF),VC(WF),NP(WF),B(SF), VC(SF),NP(SF)/SE85:B,NP,VC)
R313	1-216-047-91	RES,CHIP	820 5% 1/10W (EXCEPT SF90:B(WF))	R376	1-216-295-91	SHORT	0 (SF99)
R314	1-216-073-00	METAL CHIP	10K 5% 1/10W (EXCEPT SF90:B(WF))	R377	1-216-079-00	METAL CHIP	18K 5% 1/10W (SF90:B(WF),VC(WF),NP(WF),B(SF), VC(SF),NP(SF)/SE85:B,NP,VC)
R317	1-216-085-00	METAL CHIP	33K 5% 1/10W (EXCEPT SF90:B(WF))	R377	1-216-295-91	SHORT	0 (SF99)

Ref. No.	Part No.	Description	Quantity	Percentage	Remarks
R500	1-216-041-00	METAL CHIP	470	5%	1/10W (EXCEPT SF90:B(WF))
R501	1-216-041-00	METAL CHIP	470	5%	1/10W (EXCEPT SF90:B(WF))
R502	1-216-025-91	RES,CHIP	100	5%	1/10W
R503	1-216-025-91	RES,CHIP	100	5%	1/10W
R504	1-216-295-91	SHORT	0 (SF99)		
R505	1-216-295-91	SHORT	0 (SF99)		
R506	1-216-041-00	METAL CHIP	470	5%	1/10W (SF99)
R507	1-216-041-00	METAL CHIP	470	5%	1/10W (SF99)
R509	1-216-069-00	METAL CHIP	6.8K	5%	1/10W
R510	1-249-408-11	CARBON	180	5%	1/4W F
R511	1-249-407-11	CARBON	150	5%	1/4W F
R512	1-216-021-00	METAL CHIP	68	5%	1/10W
R514	1-216-037-00	METAL CHIP	330	5%	1/10W
R515	1-216-049-91	RES,CHIP	1K	5%	1/10W
R516	1-216-065-91	RES,CHIP	4.7K	5%	1/10W
R517	1-216-022-00	METAL CHIP	75	5%	1/10W
R518	1-216-069-00	METAL CHIP	6.8K	5%	1/10W
R519	1-216-022-00	METAL CHIP	75	5%	1/10W (SF99)
R520	1-216-021-00	METAL CHIP	68	5%	1/10W (SF99)
R521	1-249-407-11	CARBON	150	5%	1/4W F (SF99)
R522	1-216-025-91	RES,CHIP	100	5%	1/10W (SF99)
R524	1-216-025-91	RES,CHIP	100	5%	1/10W (SF99)
R525	1-249-408-11	CARBON	180	5%	1/4W F (SF99)
R541	1-216-025-91	RES,CHIP	100	5%	1/10W (EXCEPT SE85:VX/SF90:UX(WF),UX(SF),EX/SF99:UX)
R542	1-249-407-11	CARBON	150	5%	1/4W F (EXCEPT SE85:VX/SF90:UX(WF),UX(SF),EX/SF99:UX)
R543	1-249-408-11	CARBON	180	5%	1/4W F (EXCEPT SE85:VX/SF90:UX(WF),UX(SF),EX/SF99:UX)
R545	1-216-085-00	METAL CHIP	33K	5%	1/10W
R546	1-216-089-91	RES,CHIP	47K	5%	1/10W
R547	1-216-049-91	RES,CHIP	1K	5%	1/10W (EXCEPT SE85:VX/SF90:UX(WF),UX(SF),EX/SF99:UX)
R548	1-216-022-00	METAL CHIP	75	5%	1/10W
R549	1-216-022-00	METAL CHIP	75	5%	1/10W (EXCEPT SE85:VX/SF90:UX(WF),UX(SF),EX/SF99:UX)
R570	1-216-041-00	METAL CHIP	470	5%	1/10W
R571	1-216-041-00	METAL CHIP	470	5%	1/10W
R572	1-216-025-91	RES,CHIP	100	5%	1/10W (EXCEPT SE85:VX/SF90:UX(WF),UX(SF),EX/SF99:UX)
R573	1-216-025-91	RES,CHIP	100	5%	1/10W (EXCEPT SE85:VX/SF90:UX(WF),UX(SF),EX/SF99:UX)
R574	1-216-097-91	RES,CHIP	100K	5%	1/10W (EXCEPT SE85:VX/SF90:UX(WF),UX(SF),EX/SF99:UX)
R575	1-216-097-91	RES,CHIP	100K	5%	1/10W (EXCEPT SE85:VX/SF90:UX(WF),UX(SF),EX/SF99:UX)
R660	1-216-073-00	METAL CHIP	10K	5%	1/10W (SF99:EN,B/SF90:B(WF),B(SF)/SE85:B)
R661	1-216-073-00	METAL CHIP	10K	5%	1/10W (SF99:EN,B/SF90:B(WF),B(SF)/SE85:B)
R590	1-216-049-91	RES,CHIP	1K	5%	1/10W

Ref. No.	Part No.	Description	Quantity	Percentage	Remarks
R591	1-216-049-91	RES,CHIP	1K	5%	1/10W
R592	1-216-049-91	RES,CHIP	1K	5%	1/10W
R597	1-216-025-91	RES,CHIP	100	5%	1/10W
R598	1-216-025-91	RES,CHIP	100	5%	1/10W
R611	1-216-049-91	RES,CHIP	1K	5%	1/10W
R615	1-216-049-91	RES,CHIP	1K	5%	1/10W
R616	1-216-049-91	RES,CHIP	1K	5%	1/10W
R617	1-249-417-11	CARBON	1K	5%	1/4W F
R619	1-249-417-11	CARBON	1K	5%	1/4W F
R620	1-216-089-91	RES,CHIP	47K	5%	1/10W
R621	1-216-081-00	METAL CHIP	22K	5%	1/10W
R662	1-216-059-00	METAL CHIP	2.7K	5%	1/10W
R663	1-216-053-00	METAL CHIP	1.5K	5%	1/10W
R664	1-216-081-00	METAL CHIP	22K	5%	1/10W
R665	1-216-041-00	METAL CHIP	470	5%	1/10W
R666	1-216-041-00	METAL CHIP	470	5%	1/10W
R667	1-216-081-00	METAL CHIP	22K	5%	1/10W
R669	1-216-033-00	METAL CHIP	220	5%	1/10W
R670	1-216-041-00	METAL CHIP	470	5%	1/10W
R671	1-249-407-11	CARBON	150	5%	1/4W F
R674	1-216-073-00	METAL CHIP	10K	5%	1/10W
R675	1-216-063-91	RES,CHIP	3.9K	5%	1/10W
R676	1-216-043-91	RES,CHIP	560	5%	1/10W
R677	1-216-101-00	METAL CHIP	150K	5%	1/10W
R678	1-216-049-91	RES,CHIP	1K	5%	1/10W
R679	1-216-069-00	METAL CHIP	6.8K	5%	1/10W
R702	1-216-295-91	SHORT	0		
R704	1-216-041-00	METAL CHIP	470	5%	1/10W
R705	1-216-041-00	METAL CHIP	470	5%	1/10W
R706	1-216-025-91	RES,CHIP	100	5%	1/10W
R707	1-216-057-00	METAL CHIP	2.2K	5%	1/10W
R708	1-216-049-91	RES,CHIP	1K	5%	1/10W
R709	1-216-049-91	RES,CHIP	1K	5%	1/10W
△ R711	1-212-893-00	FUSIBLE	330	5%	1/4W F
R713	1-216-025-91	RES,CHIP	100	5%	1/10W
R714	1-216-113-00	METAL CHIP	470K	5%	1/10W
R719	1-216-073-00	METAL CHIP	10K	5%	1/10W (SF90:UX(WF),VC(WF),NP(WF),UX(SF), B(SF),VC(SF),NP(SF),EX/SE85)
R731	1-216-041-00	METAL CHIP	470	5%	1/10W
R733	1-216-041-00	METAL CHIP	470	5%	1/10W
R756	1-216-073-00	METAL CHIP	10K	5%	1/10W
R757	1-216-049-91	RES,CHIP	1K	5%	1/10W
R759	1-216-037-00	METAL CHIP	330	5%	1/10W
R800	1-216-101-00	METAL CHIP	150K	5%	1/10W
R801	1-216-073-00	METAL CHIP	10K	5%	1/10W
R802	1-216-073-00	METAL CHIP	10K	5%	1/10W
R803	1-216-081-00	METAL CHIP	22K	5%	1/10W
R804	1-216-073-00	METAL CHIP	10K	5%	1/10W
R805	1-216-073-00	METAL CHIP	10K	5%	1/10W
R806	1-216-073-00	METAL CHIP	10K	5%	1/10W
R807	1-216-085-00	METAL CHIP	33K	5%	1/10W
R808	1-216-089-91	RES,CHIP	47K	5%	1/10W
R813	1-216-073-00	METAL CHIP	10K	5%	1/10W
R850	1-247-807-31	CARBON	100	5%	1/4W
R851	1-216-079-00	METAL CHIP	18K	5%	1/10W
R852	1-216-083-00	METAL CHIP	27K	5%	1/10W

<p>Note : The components identified by mark △ or dotted line with mark △ are critical for safety. Replace only with part number specified.</p>	<p>Note : Les composants identifiés par une marque △ sont critiques pour la sécurité. Ne les remplacer que par une pièce portant le numéro spécifié.</p>
---	---

Ref. No.	Part No.	Description	Remarks	Ref. No.	Part No.	Description	Remarks
R853	1-216-049-91	RES,CHIP	1K 5% 1/10W			< CAPACITOR >	
R856	1-216-097-91	RES,CHIP	100K 5% 1/10W				
R857	1-216-069-00	METAL CHIP	6.8K 5% 1/10W				
R858	1-216-069-00	METAL CHIP	6.8K 5% 1/10W	C902	1-163-251-11	CERAMIC CHIP	100PF 5% 50V (SF90/SF99)
R859	1-216-123-11	METAL CHIP	1.2M 5% 1/10W	C903	1-163-009-11	CERAMIC CHIP	0.001uF 10% 50V (SF90/SF99)
R860	1-216-123-11	METAL CHIP	1.2M 5% 1/10W	C904	1-163-021-91	CERAMIC CHIP	0.01uF 10% 50V (SF90/SF99)
R861	1-216-117-00	METAL CHIP	680K 5% 1/10W	C906	1-163-009-11	CERAMIC CHIP	0.001uF 10% 50V (SF90/SF99)
R862	1-216-057-00	METAL CHIP	2.2K 5% 1/10W	C907	1-164-004-11	CERAMIC CHIP	0.1uF 10% 25V (SF90/SF99)
R890	1-216-065-91	RES,CHIP	4.7K 5% 1/10W				
R891	1-216-105-91	RES,CHIP	220K 5% 1/10W (SF99:UX,NP,B,VC/SE85) (SF99:UX,NP,B,VC/SE85)	C908	1-163-251-11	CERAMIC CHIP	100PF 5% 50V (SF90/SF99)
R892	1-216-057-00	METAL CHIP	2.2K 5% 1/10W (SF99:UX,NP,B,VC/SE85)	C909	1-163-009-11	CERAMIC CHIP	0.001uF 10% 50V (SF90/SF99)
R893	1-216-049-91	RES,CHIP	1K 5% 1/10W (SF99:UX,NP,B,VC/SE85)	C910	1-163-021-91	CERAMIC CHIP	0.01uF 10% 50V (SF90/SF99)
R894	1-216-049-91	RES,CHIP	1K 5% 1/10W (SF99:UX,NP,B,VC/SE85)	C911	1-163-009-11	CERAMIC CHIP	0.001uF 10% 50V (SF90/SF99)
R896	1-216-001-00	METAL CHIP	10 5% 1/10W (SF99:UX,NP,B,VC/SE85)	C912	1-163-021-91	CERAMIC CHIP	0.01uF 10% 50V (SF90/SF99)
		< SWITCH >					
S100	1-771-155-11	SWITCH, ROTARY		C913	1-163-249-11	CERAMIC CHIP	82PF 5% 50V (SF90/SF99)
S101	1-762-108-11	SWITCH, PUSH (1 KEY)		C914	1-164-004-11	CERAMIC CHIP	0.1uF 10% 25V (SF90/SF99)
S160	1-571-588-31	SWITCH, SLIDE		C915	1-164-004-11	CERAMIC CHIP	0.1uF 10% 25V (SF90/SF99)
		< TUNER >		C916	1-163-251-11	CERAMIC CHIP	100PF 5% 50V (SF90/SF99)
TU702	1-693-436-11	TUNER, IF (BTF-3WC428)	(SF99:EN,NP/SF90:NP(WF),NP(SF),EX/SE85:NP)	C917	1-163-021-91	CERAMIC CHIP	0.01uF 10% 50V (SF90/SF99)
TU702	1-693-437-11	TUNER, IF (BTF-3WU604)	(SF99:UX/SF90:UX(WF),UX(SF)/SE85:UX)				
TU702	1-693-438-11	TUNER, IF (BTF-3WC446)	(SF99:B/SF90:B(WF),B(SF)/SE85:B)	C919	1-164-004-11	CERAMIC CHIP	0.1uF 10% 25V (SF90/SF99)
TU702	1-693-439-11	TUNER, IF (BTF-3WC429)	(SF99:VC/SF90:VC(WF),VC(SF)/SE85:VC)	C920	1-163-021-91	CERAMIC CHIP	0.01uF 10% 50V (SF90/SF99)
		< VIBRATOR >		C921	1-128-131-11	ELECT	22uF 20% 50V (SF90/SF99)
X160	1-760-494-31	VIBRATOR, CRYSTAL		C923	1-163-021-91	CERAMIC CHIP	0.01uF 10% 50V (SF90/SF99)
X200	1-579-608-21	VIBRATOR, CRYSTAL		C924	1-124-589-11	ELECT	47uF 20% 16V (SF90/SF99)
X660	1-577-289-61	VIBRATOR, CRYSTAL					
X661	1-577-165-11	VIBLATOR, CERAMIC		C925	1-163-249-11	CERAMIC CHIP	82PF 5% 50V (SF90/SF99)
* A-6713-519-A	ML-17 COMPLETE BOARD, COMPLETE	(SF99:B/SF90:B(WF),B(SF))	*****	C928	1-128-131-11	ELECT	22uF 20% 50V (SF90/SF99)
* A-6713-520-A	ML-17 COMPLETE BOARD, COMPLETE	(SF99:EN)	*****	C929	1-164-004-11	CERAMIC CHIP	0.1uF 10% 25V (SF90/SF99)
* A-6791-915-A	ML-17 COMPLETE BOARD, COMPLETE(EXCEPT SE85/SF90:B(WF),B(SF)/SF99:B.EN)	(Ref.No.:2000 Series)	*****	C930	1-164-004-11	CERAMIC CHIP	0.1uF 10% 25V (SF90/SF99)
				C931	1-164-004-11	CERAMIC CHIP	0.1uF 10% 25V (SF90/SF99)
				C932	1-128-057-11	ELECT	330uF 20% 6.3V (SF90/SF99)
				C933	1-164-004-11	CERAMIC CHIP	0.1uF 10% 25V (SF90/SF99)
				C934	1-163-237-11	CERAMIC CHIP	27PF 5% 50V (SF90/SF99)
				C935	1-163-237-11	CERAMIC CHIP	27PF 5% 50V (SF90/SF99)
				C940	1-164-004-11	CERAMIC CHIP	0.1uF 10% 25V (SF90/SF99)

ML-17

Ref. No.	Part No.	Description	Remarks	Ref. No.	Part No.	Description	Remarks
C941	1-128-131-11	ELECT	22uF 20% 50V (SF90/SF99)			< FERRITE BEAD >	
C942	1-128-131-11	ELECT	22uF 20% 50V (SF90/SF99)	FB900	1-414-233-22	INDUCTOR CHIP	0UH (SF90/SF99)
C943	1-164-004-11	CERAMIC CHIP	0.1uF 10% 25V (SF90/SF99)	FB901	1-414-233-22	INDUCTOR CHIP	0UH (SF90/SF99)
C944	1-164-004-11	CERAMIC CHIP	0.1uF 10% 25V (SF90/SF99)	FB902	1-414-233-22	INDUCTOR CHIP	0UH (SF90/SF99)
C945	1-128-131-11	ELECT	22uF 20% 50V (SF90/SF99)	FB903	1-414-233-22	INDUCTOR CHIP	0UH (SF90/SF99)
C950	1-163-121-00	CERAMIC CHIP	150PF 5% 50V (SF90/SF99)	FB904	1-414-234-22	INDUCTOR CHIP	0UH (SF90/SF99)
C951	1-124-584-00	ELECT	100uF 20% 10V (SF90/SF99)	FB905	1-414-234-22	INDUCTOR CHIP	0UH (SF90/SF99)
C952	1-107-725-11	CERAMIC CHIP	0.1uF 10% 16V (SF90/SF99)	FB906	1-414-234-22	INDUCTOR CHIP	0UH (SF90/SF99)
C953	1-110-501-11	CERAMIC CHIP	0.33uF 10% 16V (SF90/SF99)	FB907	1-414-234-22	INDUCTOR CHIP	0UH (SF90/SF99)
C954	1-164-489-11	CERAMIC CHIP	0.22uF 10% 16V (SF90/SF99)	FB908	1-414-233-22	INDUCTOR CHIP	0UH (SF90/SF99)
C955	1-163-989-11	CERAMIC CHIP	0.033uF 10% 25V (SF90/SF99)	FB909	1-414-235-22	INDUCTOR CHIP	0UH (SF90/SF99)
C956	1-163-989-11	CERAMIC CHIP	0.033uF 10% 25V (SF90/SF99)	FB910	1-414-235-22	INDUCTOR CHIP	0UH (SF90/SF99)
C957	1-107-725-11	CERAMIC CHIP	0.1uF 10% 16V (SF90/SF99)	FB911	1-414-235-22	INDUCTOR CHIP	0UH (SF90/SF99)
C959	1-107-725-11	CERAMIC CHIP	0.1uF 10% 16V (SF90/SF99)	FB912	1-414-235-22	INDUCTOR CHIP	0UH (SF90/SF99)
C960	1-163-237-11	CERAMIC CHIP	27PF 5% 50V (SF90/SF99)	FB950	1-414-233-22	INDUCTOR CHIP	0UH (SF90/SF99)
C961	1-163-237-11	CERAMIC CHIP	27PF 5% 50V (SF90/SF99)	FB951	1-414-233-22	INDUCTOR CHIP	0UH (SF90/SF99)
C962	1-107-725-11	CERAMIC CHIP	0.1uF 10% 16V (SF90/SF99)	FB952	1-414-233-22	INDUCTOR CHIP	0UH (SF90/SF99)
C963	1-124-584-00	ELECT	100uF 20% 10V (SF90/SF99)			< IC >	
C964	1-107-725-11	CERAMIC CHIP	0.1uF 10% 16V (SF90/SF99)	IC900	8-759-100-93	IC uPC393G2-E2	(SF90/SF99)
C980	1-163-021-91	CERAMIC CHIP	0.01uF 10% 50V (SF90/SF99)	IC901	8-759-587-89	IC CXD8753AQ	(EXCEPT SE85/SF90:B(WF),B(SF)/SF99:B.EN)
C981	1-124-589-11	ELECT	47uF 20% 16V (SF90/SF99)	IC902	8-752-902-96	IC CXP84632-042Q	(SF99:B/SF90:B(WF),B(SF))
C984	1-124-589-11	ELECT	47uF 20% 16V (SF90/SF99)	IC902	8-752-907-89	IC CXP84632-061Q	(EXCEPT SE85/SF90:B(WF),B(SF)/SF99:B.EN)
		< CONNECTOR >		IC902	8-752-909-50	IC CXP84632-060Q	(SF99:EN)
* CN900	1-568-941-11	PIN, CONNECTOR 3P	(SF90/SF99)	IC903	8-759-527-75	IC M24C04-MN6T	(SF90/SF99)
* CN901	1-568-941-11	PIN, CONNECTOR 3P	(SF90/SF99)	IC950	8-759-376-75	IC SDA5250M-C5-GEG	(SF90/SF99)
CN950	1-784-494-11	CONNECTOR, FFC/FPC 15P	(SF90/SF99)	IC951	8-759-577-63	IC MX23C4000PC-12-TET11	(SF90/SF99)
		< DIODE >				< JUMPER RESISTOR >	
D900	8-719-911-19	DIODE 1SS119-25TD	(SF90/SF99)	JR001	1-216-295-91	SHORT	0
D901	8-719-911-19	DIODE 1SS119-25TD	(SF90/SF99)	JR002	1-216-296-91	SHORT	0 (SF90/SF99)
D902	8-719-911-19	DIODE 1SS119-25TD	(SF90/SF99)	JR003	1-216-296-91	SHORT	0 (SF90/SF99)
D903	8-719-911-19	DIODE 1SS119-25TD	(SF90/SF99)	JR004	1-216-296-91	SHORT	0 (SF90/SF99)
D904	8-719-200-82	DIODE MPG06D-6052PKG3	(SF90/SF99)	JR005	1-216-296-91	SHORT	0 (SF90/SF99)
D905	8-719-911-19	DIODE 1SS119-25TD	(SF90/SF99)	JR006	1-216-295-91	SHORT	0
D907	8-719-911-19	DIODE 1SS119-25TD	(SF90/SF99)	JR007	1-216-296-91	SHORT	0 (SF90/SF99)
				JR008	1-216-296-91	SHORT	0 (SF90/SF99)
				JR009	1-216-296-91	SHORT	0 (SF90/SF99)
				JR011	1-216-296-91	SHORT	0 (SF90/SF99)
				JR012	1-216-296-91	SHORT	0 (SF90/SF99)
				JR022	1-216-295-91	SHORT	0 (EXCEPT SF99:NP)
				JR023	1-216-295-91	SHORT	0 (EXCEPT SF90:VC(SF)/SF99:NP)
				JR024	1-216-295-91	SHORT	0 (EXCEPT SF90:VC(SF)/SF99:NP)
				JS954	1-216-295-91	SHORT	0 (SF90/SF99)
						< COIL >	
				L900	1-414-934-21	INDUCTOR	10uH (SF90/SF99)
				L901	1-414-934-21	INDUCTOR	10uH (SF90/SF99)
				L902	1-414-934-21	INDUCTOR	10uH (SF90/SF99)
				L903	1-414-934-21	INDUCTOR	10uH (SF90/SF99)
				L904	1-414-940-21	INDUCTOR	100uH (SF90/SF99)

Ref. No.	Part No.	Description	Remarks	Ref. No.	Part No.	Description	Remarks
L905	1-414-936-21	INDUCTOR	22uH (SF90/SF99)	R909	1-216-049-91	RES,CHIP	1K 5% 1/10W (SF90/SF99)
L907	1-414-936-21	INDUCTOR	22uH (SF90/SF99)	R910	1-249-398-11	CARBON	27 5% 1/4W F (SF90/SF99)
L912	1-414-936-21	INDUCTOR	22uH (SF90/SF99)	R911	1-216-065-91	RES,CHIP	4.7K 5% 1/10W (SF90/SF99)
L950	1-414-934-21	INDUCTOR	10uH (SF90/SF99)	R912	1-216-049-91	RES,CHIP	1K 5% 1/10W (SF90/SF99)
L961	1-414-940-21	INDUCTOR	100uH (SF90/SF99)	R914	1-216-295-91	SHORT	0 (SF90/SF99)
< IC LINK >				R915	1-216-065-91	RES,CHIP	4.7K 5% 1/10W (SF90/SF99)
PS901	1-801-553-21	PROTECTOR, MODUL (SF90/SF99)		R916	1-216-025-91	RES,CHIP	100 5% 1/10W (SF90/SF99)
PS950	1-576-319-21	PROTECTOR, MODULE (SF90/SF99)		R918	1-216-065-91	RES,CHIP	4.7K 5% 1/10W (SF90/SF99)
< TRANSISTOR >				R919	1-216-057-00	METAL CHIP	2.2K 5% 1/10W (SF90/SF99)
Q900	8-729-216-22	TRANSISTOR	2PB709AR-115 (SF90/SF99)	R921	1-216-065-91	RES,CHIP	4.7K 5% 1/10W (SF90/SF99)
Q901	8-729-044-60	TRANSISTOR	2SC3383-T-AA (SF90/SF99)	R922	1-216-045-00	METAL CHIP	680 5% 1/10W (SF90/SF99)
Q902	8-729-044-60	TRANSISTOR	2SC3383-T-AA (SF90/SF99)	R923	1-216-025-91	RES,CHIP	100 5% 1/10W (SF90/SF99)
Q903	8-729-421-19	TRANSISTOR	MUN2213T1 (SF90/SF99)	R924	1-216-057-00	METAL CHIP	2.2K 5% 1/10W (SF90/SF99)
Q904	8-729-422-33	TRANSISTOR	2PD601AR-115 (SF90/SF99)	R925	1-216-045-00	METAL CHIP	680 5% 1/10W (SF90/SF99)
Q905	8-729-422-33	TRANSISTOR	2PD601AR-115 (SF90/SF99)	R927	1-216-089-91	RES,CHIP	47K 5% 1/10W (SF90/SF99)
Q906	8-729-216-22	TRANSISTOR	2PB709AR-115 (SF90/SF99)	R928	1-216-081-00	METAL CHIP	22K 5% 1/10W (SF90/SF99)
Q907	8-729-216-22	TRANSISTOR	2PB709AR-115 (SF90/SF99)	R929	1-216-025-91	RES,CHIP	100 5% 1/10W (SF90/SF99)
Q908	8-729-422-33	TRANSISTOR	2PD601AR-115 (SF90/SF99)	R930	1-216-089-91	RES,CHIP	47K 5% 1/10W (SF90/SF99)
Q909	8-729-422-33	TRANSISTOR	2PD601AR-115 (SF90/SF99)	R931	1-216-081-00	METAL CHIP	22K 5% 1/10W (SF90/SF99)
Q910	8-729-421-19	TRANSISTOR	MUN2213T1 (SF90/SF99)	R932	1-216-025-91	RES,CHIP	100 5% 1/10W (SF90/SF99)
Q911	8-729-044-60	TRANSISTOR	2SC3383-T-AA (SF90/SF99)	R933	1-216-049-91	RES,CHIP	1K 5% 1/10W (SF90/SF99)
Q912	8-729-421-19	TRANSISTOR	MUN2213T1 (SF90/SF99)	R934	1-216-017-91	RES,CHIP	47 5% 1/10W (SF90/SF99)
Q913	8-729-044-60	TRANSISTOR	2SC3383-T-AA (SF90/SF99)	R935	1-216-057-00	METAL CHIP	2.2K 5% 1/10W (SF90/SF99)
Q914	8-729-421-19	TRANSISTOR	MUN2213T1 (SF90/SF99)	R936	1-216-049-91	RES,CHIP	1K 5% 1/10W (SF90/SF99)
Q915	8-729-216-22	TRANSISTOR	2PB709AR-115 (SF90/SF99)	R938	1-216-017-91	RES,CHIP	47 5% 1/10W (SF90/SF99)
Q916	8-729-804-41	TRANSISTOR	2SB1122-ST-TD (SF90/SF99)	R939	1-249-402-11	CARBON	56 5% 1/4W F (SF90/SF99)
Q917	8-729-421-19	TRANSISTOR	MUN2213T1 (SF90/SF99)	R941	1-249-398-11	CARBON	27 5% 1/4W F (SF90/SF99)
< RESISTOR >				R942	1-216-065-91	RES,CHIP	4.7K 5% 1/10W (SF90/SF99)
R001	1-216-041-00	METAL CHIP	470 5% 1/10W (EXCEPT SE85/SF90:B(WF),NP(WF),UX(SF)/SF99:EN)	R943	1-216-063-91	RES,CHIP	3.9K 5% 1/10W (SF90/SF99)
R002	1-216-041-00	METAL CHIP	470 5% 1/10W (EXCEPT SE85/SF90:B(WF),NP(WF),UX(SF)/SF99:EN)	R944	1-216-065-91	RES,CHIP	4.7K 5% 1/10W (SF90/SF99)
R003	1-249-413-11	CARBON	470 5% 1/4W F (EXCEPT SE85/SF90:B(WF),NP(WF),UX(SF)/SF99:EN)				
R004	1-249-413-11	CARBON	470 5% 1/4W F (EXCEPT SE85/SF90:B(WF),NP(WF),UX(SF)/SF99:EN)				
R005	1-249-413-11	CARBON	470 5% 1/4W F (EXCEPT SE85/SF90:B(WF),NP(WF),UX(SF)/SF99:EN)				
R006	1-216-041-00	METAL CHIP	470 5% 1/10W (EXCEPT SF90:B(WF),UX(SF)/SF90:EN)				
R007	1-216-041-00	METAL CHIP	470 5% 1/10W (SF90/SF99)				
R008	1-216-073-00	METAL CHIP	10K 5% 1/10W (SF90/SF99)				
R009	1-216-073-00	METAL CHIP	10K 5% 1/10W (SF90/SF99)				
R900	1-216-045-00	METAL CHIP	680 5% 1/10W (SF90/SF99)				
R902	1-216-057-00	METAL CHIP	2.2K 5% 1/10W (SF90/SF99)				
R903	1-216-025-91	RES,CHIP	100 5% 1/10W (SF90/SF99)				
R905	1-216-049-91	RES,CHIP	1K 5% 1/10W (SF90/SF99)				
R907	1-249-402-11	CARBON	56 5% 1/4W F (SF90/SF99)				
R908	1-216-049-91	RES,CHIP	1K 5% 1/10W (SF90/SF99)				

Ref. No.	Part No.	Description	Remarks	Ref. No.	Part No.	Description	Remarks
R946	1-216-295-91	SHORT	0 (SF90/SF99)	R998	1-216-295-91	SHORT	0 (SF90/SF99)
R947	1-216-063-91	RES,CHIP	3.9K 5% 1/10W (SF90/SF99)	R999	1-216-073-00	METAL CHIP	10K 5% 1/10W (SF90/SF99)
R948	1-216-065-91	RES,CHIP	4.7K 5% 1/10W (SF90/SF99)			< VIBRATOR >	
R949	1-216-025-91	RES,CHIP	100 5% 1/10W (SF90/SF99)	X900	1-767-914-21	VIBRATOR, CRYSTAL(13.56MHz)	(SF90/SF99)
R951	1-216-057-00	METAL CHIP	2.2K 5% 1/10W (SF90/SF99)	X901	1-760-995-21	VIBRATOR, CERAMIC(16MHz)	(SF90/SF99)
R952	1-216-057-00	METAL CHIP	2.2K 5% 1/10W (SF90/SF99)	X950	1-781-039-21	VIBRATOR, CRYSTAL(18MHz)	(SF90/SF99)
R953	1-216-071-00	METAL CHIP	8.2K 5% 1/10W (SF90/SF99)	* A-6791-959-A NR-27 COMPLETE BOARD, COMPLETE (SF99:UX,EN,NP,VC) ***** (Ref.No.:2000 Series)			
R954	1-216-069-00	METAL CHIP	6.8K 5% 1/10W (SF90/SF99)			< CAPACITOR >	
R955	1-216-069-00	METAL CHIP	6.8K 5% 1/10W (SF90/SF99)	C001	1-164-346-11	CERAMIC CHIP	1uF 16V
R956	1-216-095-00	METAL CHIP	82K 5% 1/10W (SF90/SF99)	C002	1-124-584-00	ELECT	100uF 20% 10V
R957	1-216-113-00	METAL CHIP	470K 5% 1/10W (SF90/SF99)	C003	1-124-589-11	ELECT	47uF 20% 16V
R958	1-216-053-00	METAL CHIP	1.5K 5% 1/10W (SF90/SF99)	C004	1-164-346-11	CERAMIC CHIP	1uF 16V
R959	1-216-053-00	METAL CHIP	1.5K 5% 1/10W (SF90/SF99)	C005	1-124-465-00	ELECT	0.47uF 20% 50V
R962	1-216-295-91	SHORT	0 (SF90/SF99)	C006	1-124-465-00	ELECT	0.47uF 20% 50V
R965	1-216-295-91	SHORT	0 (SF90/SF99)	C007	1-124-589-11	ELECT	47uF 20% 16V
R967	1-216-295-91	SHORT	0 (SF90/SF99)	C008	1-124-589-11	ELECT	47uF 20% 16V
R969	1-216-045-00	METAL CHIP	680 5% 1/10W (SF90/SF99)	C010	1-163-031-11	CERAMIC CHIP	0.01uF 50V
R970	1-216-121-91	RES,CHIP	1M 5% 1/10W (SF90/SF99)	C012	1-163-031-11	CERAMIC CHIP	0.01uF 50V
R972	1-216-049-91	RES,CHIP	1K 5% 1/10W (SF90/SF99)	C014	1-163-031-11	CERAMIC CHIP	0.01uF 50V
R973	1-216-049-91	RES,CHIP	1K 5% 1/10W (SF90/SF99)	C015	1-164-346-11	CERAMIC CHIP	1uF 16V
R974	1-216-295-91	SHORT	0 (SF90/SF99)	C016	1-124-465-00	ELECT	0.47uF 20% 50V
R975	1-216-295-91	SHORT	0 (SE85:B/SF90/SF99)	C017	1-163-251-11	CERAMIC CHIP	100PF 5% 50V
R976	1-216-295-91	SHORT	0 (SF90/SF99)	C018	1-163-031-11	CERAMIC CHIP	0.01uF 50V
R977	1-216-089-91	RES,CHIP	47K 5% 1/10W (SE85:B/SF90/SF99)	C020	1-163-038-91	CERAMIC CHIP	0.1uF 25V
R978	1-216-089-91	RES,CHIP	47K 5% 1/10W (SF90/SF99)	C021	1-163-021-91	CERAMIC CHIP	0.01uF 10% 50V
R979	1-216-043-91	RES,CHIP	560 5% 1/10W (SF90/SF99)	C022	1-126-157-11	ELECT	10uF 20% 16V
R981	1-216-295-91	SHORT	0 (SF90/SF99)	C023	1-109-982-11	CERAMIC CHIP	1uF 10% 10V
R983	1-216-295-91	SHORT	0 (SF90/SF99)	C024	1-124-257-00	ELECT	2.2uF 20% 50V
R984	1-216-295-91	SHORT	0 (SF90/SF99)	C025	1-109-982-11	CERAMIC CHIP	1uF 10% 10V
R985	1-216-295-91	SHORT	0 (SF90/SF99)	C026	1-109-982-11	CERAMIC CHIP	1uF 10% 10V
R986	1-216-041-00	METAL CHIP	470 5% 1/10W (SF90/SF99)	C027	1-109-982-11	CERAMIC CHIP	1uF 10% 10V
R987	1-216-041-00	METAL CHIP	470 5% 1/10W (SF90/SF99)	C028	1-124-589-11	ELECT	47uF 20% 16V
R988	1-216-041-00	METAL CHIP	470 5% 1/10W (SF90/SF99)	C029	1-164-505-11	CERAMIC CHIP	2.2uF 16V
R989	1-216-041-00	METAL CHIP	470 5% 1/10W (SF90/SF99)	C030	1-164-505-11	CERAMIC CHIP	2.2uF 16V
R993	1-216-073-00	METAL CHIP	10K 5% 1/10W (SF90/SF99)	C031	1-164-505-11	CERAMIC CHIP	2.2uF 16V
				C032	1-124-589-11	ELECT	47uF 20% 16V
				C033	1-109-982-11	CERAMIC CHIP	1uF 10% 10V
				C034	1-109-982-11	CERAMIC CHIP	1uF 10% 10V
				C036	1-163-038-91	CERAMIC CHIP	0.1uF 25V
				C037	1-163-038-91	CERAMIC CHIP	0.1uF 25V
				C038	1-164-505-11	CERAMIC CHIP	2.2uF 16V
				C040	1-163-038-91	CERAMIC CHIP	0.1uF 25V
				C041	1-163-031-11	CERAMIC CHIP	0.01uF 50V
				C042	1-164-505-11	CERAMIC CHIP	2.2uF 16V
				C045	1-163-031-11	CERAMIC CHIP	0.01uF 50V
				C046	1-163-251-11	CERAMIC CHIP	100PF 5% 50V
				C047	1-163-031-11	CERAMIC CHIP	0.01uF 50V
				C048	1-163-031-11	CERAMIC CHIP	0.01uF 50V

Ref. No.	Part No.	Description	Remarks	Ref. No.	Part No.	Description	Remarks
		< CONNECTOR >					
CN001	1-573-825-11	CONNECTOR, BOARD TO BOARD 11P		R023	1-216-097-91	RES,CHIP 100K	5% 1/10W
		< FILTER >		R024	1-216-025-91	RES,CHIP 100	5% 1/10W
FL001	1-234-083-11	FILTER, LOW PASS		R025	1-216-049-91	RES,CHIP 1K	5% 1/10W
FL002	1-234-084-11	FILTER, BAND PASS		R027	1-216-295-91	SHORT 0	
		< IC >		R029	1-216-049-91	RES,CHIP 1K	5% 1/10W
IC001	8-759-431-14	IC PQ3TZ53U		R030	1-216-040-00	RES,CHIP 430	5% 1/10W
IC002	8-759-583-41	IC MM1116XFBE		R031	1-216-041-00	METAL CHIP 470	5% 1/10W
IC003	8-759-493-00	IC LC74391E		R032	1-216-049-91	RES,CHIP 1K	5% 1/10W
IC004	8-759-432-78	IC MM1111XFBE		R033	1-216-041-00	METAL CHIP 470	5% 1/10W
		< COIL >		R034	1-216-295-91	SHORT 0	
L001	1-414-934-21	INDUCTOR 10uH		R035	1-216-061-00	METAL CHIP 3.3K	5% 1/10W
L002	1-414-934-21	INDUCTOR 10uH		R036	1-216-121-91	RES,CHIP 1M	5% 1/10W
L003	1-414-934-21	INDUCTOR 10uH		R037	1-216-052-00	METAL CHIP 1.3K	5% 1/10W
L004	1-414-936-21	INDUCTOR 22uH		R038	1-216-078-00	RES,CHIP 16K	5% 1/10W
		< TRANSISTOR >		R041	1-216-067-00	METAL CHIP 5.6K	5% 1/10W
Q001	8-729-216-22	TRANSISTOR 2PB709AR-115		R042	1-216-081-00	METAL CHIP 22K	5% 1/10W
Q002	8-729-422-33	TRANSISTOR 2PD601AR-115		R043	1-216-021-00	METAL CHIP 68	5% 1/10W
Q003	8-729-216-22	TRANSISTOR 2PB709AR-115		R044	1-216-041-00	METAL CHIP 470	5% 1/10W
Q004	8-729-422-33	TRANSISTOR 2PD601AR-115		R045	1-216-061-00	METAL CHIP 3.3K	5% 1/10W
Q005	8-729-216-22	TRANSISTOR 2PB709AR-115		R046	1-216-049-91	RES,CHIP 1K	5% 1/10W
Q006	8-729-422-33	TRANSISTOR 2PD601AR-115		R047	1-216-075-00	METAL CHIP 12K	5% 1/10W
Q007	8-729-422-33	TRANSISTOR 2PD601AR-115		R048	1-216-041-00	METAL CHIP 470	5% 1/10W
Q008	8-729-216-22	TRANSISTOR 2PB709AR-115				< VARIABLE RESISTOR >	
Q009	8-729-422-33	TRANSISTOR 2PD601AR-115		RV001	1-241-763-11	RES, ADJ, CERMET 4.7K	
Q010	8-729-216-22	TRANSISTOR 2PB709AR-115		RV002	1-241-763-11	RES, ADJ, CERMET 4.7K	
Q011	8-729-216-22	TRANSISTOR 2PB709AR-115					
Q012	8-729-216-22	TRANSISTOR 2PB709AR-115					
Q013	8-729-216-22	TRANSISTOR 2PB709AR-115					
		< RESISTOR >					
R002	1-216-081-00	METAL CHIP 22K	5% 1/10W				
R003	1-216-073-00	METAL CHIP 10K	5% 1/10W				
R004	1-216-041-00	METAL CHIP 470	5% 1/10W				
			(SF99:UX,NP,VC)				
R005	1-216-021-00	METAL CHIP 68	5% 1/10W				
R006	1-216-049-91	RES,CHIP 1K	5% 1/10W				
			(SF99:UX,NP,VC)				
R007	1-216-049-91	RES,CHIP 1K	5% 1/10W				
R008	1-216-049-91	RES,CHIP 1K	5% 1/10W				
R010	1-216-055-00	METAL CHIP 1.8K	5% 1/10W				
R011	1-216-017-91	RES,CHIP 47	5% 1/10W				
R012	1-216-041-00	METAL CHIP 470	5% 1/10W				
R013	1-216-031-00	METAL CHIP 180	5% 1/10W				
R014	1-216-037-00	METAL CHIP 330	5% 1/10W				
R015	1-216-065-91	RES,CHIP 4.7K	5% 1/10W				
R016	1-216-041-00	METAL CHIP 470	5% 1/10W				
R017	1-216-041-00	METAL CHIP 470	5% 1/10W				
R018	1-216-047-91	RES,CHIP 820	5% 1/10W				
R019	1-216-081-00	METAL CHIP 22K	5% 1/10W				
R020	1-216-075-00	METAL CHIP 12K	5% 1/10W				
R021	1-216-049-91	RES,CHIP 1K	5% 1/10W				
R022	1-216-049-91	RES,CHIP 1K	5% 1/10W				
		< CAPACITOR >					
				C266	1-163-031-11	CERAMIC CHIP 0.01uF	50V
				C271	1-163-021-91	CERAMIC CHIP 0.01uF	10% 50V
				C272	1-164-004-11	CERAMIC CHIP 0.1uF	10% 25V
				C275	1-163-021-91	CERAMIC CHIP 0.01uF	10% 50V
				C276	1-164-004-11	CERAMIC CHIP 0.1uF	10% 25V
				C278	1-163-037-11	CERAMIC CHIP 0.022uF	10% 25V
				C279	1-164-004-11	CERAMIC CHIP 0.1uF	10% 25V
				C280	1-124-584-00	ELECT 100uF	20% 10V
				C281	1-163-021-91	CERAMIC CHIP 0.01uF	10% 50V
				C282	1-163-021-91	CERAMIC CHIP 0.01uF	10% 50V
				C283	1-163-021-91	CERAMIC CHIP 0.01uF	10% 50V
				C284	1-164-489-11	CERAMIC CHIP 0.22uF	10% 16V
				C285	1-163-021-91	CERAMIC CHIP 0.01uF	10% 50V
							(SF90/SF99)
				C288	1-163-021-91	CERAMIC CHIP 0.01uF	10% 50V
							(SF90/SF99)
				C289	1-163-239-11	CERAMIC CHIP 33PF	5% 50V
							(SF90/SF99)

RP-235

Ref. No.	Part No.	Description	Remarks	Ref. No.	Part No.	Description	Remarks
C290	1-163-021-91	CERAMIC CHIP	0.01uF 10% 50V (SF90/SF99)			< JUMPER RESISTOR >	
C291	1-163-021-91	CERAMIC CHIP	0.01uF 10% 50V (SF90/SF99)	JR251	1-216-296-91	SHORT 0	(EXCEPT SF90:VC(SF)/SF90:NP)
C292	1-163-021-91	CERAMIC CHIP	0.01uF 10% 50V (SF90/SF99)	JR252	1-216-296-91	SHORT 0	(EXCEPT SF90:VC(SF))
C293	1-124-257-00	ELECT	2.2uF 20% 50V (SF90/SF99)	JR253	1-216-295-91	SHORT 0	(EXCEPT SF90:VC(SF))
C294	1-163-021-91	CERAMIC CHIP	0.01uF 10% 50V (SF90/SF99)	JR260	1-216-296-91	SHORT 0	
C295	1-163-021-91	CERAMIC CHIP	0.01uF 10% 50V (SF90/SF99)	JS323	1-216-295-91	SHORT 0	
C296	1-124-589-11	ELECT	47uF 20% 16V (SF90/SF99)	JS331	1-216-295-91	SHORT 0	(SF90)
C321	1-124-589-11	ELECT	47uF 20% 16V	JS332	1-216-295-91	SHORT 0	(SE85)
C322	1-163-021-91	CERAMIC CHIP	0.01uF 10% 50V			< COIL >	
C323	1-163-021-91	CERAMIC CHIP	0.01uF 10% 50V	L270	1-414-940-21	INDUCTOR	100uH
C324	1-104-697-11	FILM	0.047uF 5% 100V (SF90)	L271	1-414-939-21	INDUCTOR	68uH (SF90/SF99)
C324	1-137-462-11	FILM	0.018uF 5% 100V (SE85/SF99)	L272	1-414-940-21	INDUCTOR	100uH (SF90/SF99)
C331	1-126-933-11	ELECT	100uF 20% 16V (SE85/SF99)	L322	1-414-940-21	INDUCTOR	100uH
C332	1-163-021-91	CERAMIC CHIP	0.01uF 10% 50V (SE85/SF99)	L331	1-410-687-11	INDUCTOR	1.2mH (SF90/SF99)
C333	1-163-237-11	CERAMIC CHIP	27PF 5% 50V	L332	1-414-181-11	INDUCTOR	4.7uH
C334	1-163-011-11	CERAMIC CHIP	0.0015uF 10% 50V (SE85/SF99)	L341	1-414-940-21	INDUCTOR	100uH
C335	1-137-397-11	FILM	0.047uF 5% 100V (SE85/SF99)			< IC LINK >	
C340	1-163-031-11	CERAMIC CHIP	0.01uF 50V	△ PS320	1-801-552-21	PROTECTOR, MODUL (250mA)	
C341	1-124-584-00	ELECT	100uF 20% 10V	△ PS331	1-576-319-21	PROTECTOR, MODULE (125mA) (SF90/SF99)	
C342	1-164-004-11	CERAMIC CHIP	0.1uF 10% 25V			< TRANSISTOR >	
C346	1-163-021-91	CERAMIC CHIP	0.01uF 10% 50V	Q271	8-729-422-33	TRANSISTOR	2PD601AR-115
C350	1-164-004-11	CERAMIC CHIP	0.1uF 10% 25V	Q272	8-729-422-33	TRANSISTOR	2PD601AR-115 (SF90/SF99)
C352	1-163-009-11	CERAMIC CHIP	0.001uF 10% 50V	Q273	8-729-043-29	TRANSISTOR	PDTC144EK-115 (SF90/SF99)
C353	1-163-038-91	CERAMIC CHIP	0.1uF 25V	Q274	8-729-422-33	TRANSISTOR	2PD601AR-115 (SF90/SF99)
C357	1-163-009-11	CERAMIC CHIP	0.001uF 10% 50V	Q275	8-729-422-33	TRANSISTOR	2PD601AR-115 (SF90/SF99)
C358	1-163-038-91	CERAMIC CHIP	0.1uF 25V	Q276	8-729-422-33	TRANSISTOR	2PD601AR-115 (SF90/SF99)
C359	1-163-031-11	CERAMIC CHIP	0.01uF 50V	Q277	8-729-216-22	TRANSISTOR	2PB709AR-115 (SF90/SF99)
		< CONNECTOR >		Q278	8-729-216-22	TRANSISTOR	2PB709AR-115 (SF90/SF99)
CN260	1-784-492-11	CONNECTOR, FFC/FPC 13P		Q320	8-729-804-41	TRANSISTOR	2SB1122-ST-TD
* CN261	1-564-030-00	PIN, CONNECTOR 5P		Q321	8-729-802-91	TRANSISTOR	2SD879-AA
CN301	1-506-481-11	PIN, CONNECTOR 2P		Q331	8-729-012-31	TRANSISTOR	2SC4040-TL2-Q (SE85/SF99)
* CN302	1-568-942-11	PIN, CONNECTOR 4P		Q332	8-729-900-51	TRANSISTOR	UN2115-QRS(TX) (SE85/SF99)
* CN341	1-564-027-00	PIN, CONNECTOR 2P				< RESISTOR >	
CN342	1-573-825-11	CONNECTOR, BOARD TO BOARD 11P		R270	1-216-041-00	METAL CHIP	470 5% 1/10W
CN343	1-764-867-41	CONNECTOR, BOARD TO BOARD 20P		R271	1-216-041-00	METAL CHIP	470 5% 1/10W
		< IC >		R272	1-216-057-00	METAL CHIP	2.2K 5% 1/10W
IC260	8-759-564-36	IC LA70011		R273	1-216-295-91	SHORT	0
IC301	8-759-499-30	IC BA7755AF-E2		R274	1-216-065-91	RES,CHIP	4.7K 5% 1/10W
IC340	8-759-486-92	IC LA7256		R276	1-216-069-00	METAL CHIP	6.8K 5% 1/10W
				R277	1-216-081-00	METAL CHIP	22K 5% 1/10W
				R278	1-216-081-00	METAL CHIP	22K 5% 1/10W
				R279	1-216-081-00	METAL CHIP	22K 5% 1/10W
				R280	1-216-079-00	METAL CHIP	18K 5% 1/10W (SF90/SF99)

<p>Note : The components identified by mark △ or dotted line with mark △ are critical for safety. Replace only with part number specified.</p>	<p>Note : Les composants identifiés par une marque △ sont critiques pour la sécurité. Ne les remplacer que par une pièce portant le numéro spécifié.</p>
---	---

Ref. No.	Part No.	Description	Remarks	Ref. No.	Part No.	Description	Remarks
R283	1-216-059-00	METAL CHIP	2.7K 5% 1/10W	R346	1-216-065-91	RES,CHIP 4.7K 5% 1/10W	(SF99:EN,NP,B,VC/SF90/SE85)
R285	1-216-049-91	RES,CHIP	1K 5% 1/10W	R347	1-216-065-91	RES,CHIP 4.7K 5% 1/10W	(SF99:EN,NP,B,VC/SF90/SE85)
R286	1-216-053-00	METAL CHIP	1.5K 5% 1/10W	R348	1-216-033-00	METAL CHIP 220 5% 1/10W	(SF99:EN,NP,B,VC/SF90/SE85)
R287	1-208-771-11	RES,CHIP	360 5% 1/10W	< TRANSFORMER >			
R288	1-216-081-00	METAL CHIP	22K 5% 1/10W	T321	1-431-100-11	TRANSFORMER, BIAS OSCILLATION	(SF99:EN,NP,B,VC/SE85)
R289	1-216-049-91	RES,CHIP	1K 5% 1/10W	T331	1-423-415-11	TRANSFORMER, BIAS OSCILLATION	(SF99:EN,NP,B,VC/SE85)
R290	1-216-057-00	METAL CHIP	2.2K 5% 1/10W				
R291	1-216-041-00	METAL CHIP	470 5% 1/10W	*	A-6791-918-A	SE-90 BOARD, COMPLETE	(EXCEPT SE85:B/SF90:B(WF),B(SF)/SF99:B)
R292	1-216-033-00	METAL CHIP	220 5% 1/10W	*****			
R293	1-216-053-00	METAL CHIP	1.5K 5% 1/10W	*	A-6791-923-A	SE-90 COMPLETE BOARD, COMPLETE	(SF99:B/SF90:B(WF),B(SF)/SE85:B)
R294	1-216-073-00	METAL CHIP	10K 5% 1/10W	*****			
R295	1-216-061-00	METAL CHIP	3.3K 5% 1/10W	(Ref.No:3000 Series)			
R296	1-216-061-00	METAL CHIP	3.3K 5% 1/10W	< CAPACITOR >			
R297	1-216-049-91	RES,CHIP	1K 5% 1/10W	C970	1-163-259-91	CERAMIC CHIP 220PF 5% 50V	(SF99:B/SF90:B(WF),B(SF)/SE85:B)
R298	1-216-073-00	METAL CHIP	10K 5% 1/10W	C971	1-124-257-00	ELECT 2.2uF 20% 50V	(SF99:B/SF90:B(WF),B(SF)/SE85:B)
R317	1-216-079-00	METAL CHIP	18K 5% 1/10W	C972	1-163-017-00	CERAMIC CHIP 0.0047uF 5% 50V	(SF99:B/SF90:B(WF),B(SF)/SE85:B)
R320	1-216-081-00	METAL CHIP	22K 5% 1/10W	C973	1-163-021-91	CERAMIC CHIP 0.01uF 10% 50V	(SF99:B/SF90:B(WF),B(SF)/SE85:B)
R321	1-216-017-91	RES,CHIP	47 5% 1/10W	C974	1-109-982-11	CERAMIC CHIP 1uF 10% 10V	(SF99:B/SF90:B(WF),B(SF)/SE85:B)
R322	1-216-063-91	RES,CHIP	3.9K 5% 1/10W	C975	1-163-037-11	CERAMIC CHIP 0.022uF 10% 25V	(SF99:B/SF90:B(WF),B(SF)/SE85:B)
R322	1-216-067-00	METAL CHIP	5.6K 5% 1/10W	C976	1-163-259-91	CERAMIC CHIP 220PF 5% 50V	(SF99:B/SF90:B(WF),B(SF)/SE85:B)
R323	1-217-671-11	METAL CHIP	1 5% 1/10W	C977	1-163-021-91	CERAMIC CHIP 0.01uF 10% 50V	(SF99:B/SF90:B(WF),B(SF)/SE85:B)
R324	1-216-031-00	METAL CHIP	180 5% 1/10W	C978	1-163-017-00	CERAMIC CHIP 0.0047uF 5% 50V	(SF99:B/SF90:B(WF),B(SF)/SE85:B)
R332	1-216-083-00	METAL CHIP	27K 5% 1/10W	C979	1-163-121-00	CERAMIC CHIP 150PF 5% 50V	(SF99:B/SF90:B(WF),B(SF)/SE85:B)
R333	1-249-394-11	CARBON	12 5% 1/4W F	C980	1-164-004-11	CERAMIC CHIP 0.1uF 10% 25V	(SF99:B/SF90:B(WF),B(SF)/SE85:B)
R334	1-216-035-00	METAL CHIP	270 5% 1/10W	C981	1-163-021-91	CERAMIC CHIP 0.01uF 10% 50V	(SF99:B/SF90:B(WF),B(SF)/SE85:B)
R334	1-216-037-00	METAL CHIP	330 5% 1/10W	C982	1-163-007-11	CERAMIC CHIP 680PF 10% 50V	(SF99:B/SF90:B(WF),B(SF)/SE85:B)
R336	1-216-296-91	SHORT	0 (SF90)	C983	1-163-009-11	CERAMIC CHIP 0.001uF 10% 50V	(SF99:B/SF90:B(WF),B(SF)/SE85:B)
< TRANSFORMER >				C984	1-163-021-91	CERAMIC CHIP 0.01uF 10% 50V	(SF99:B/SF90:B(WF),B(SF)/SE85:B)
T321	1-431-097-11	TRANSFORMER, BIAS OSCILLATION	(SF90)	C985	1-163-251-11	CERAMIC CHIP 100PF 5% 50V	(SF99:B/SF90:B(WF),B(SF)/SE85:B)
< RESISTOR >				C986	1-126-964-11	ELECT 10uF 20% 50V	(SF99:B/SF90:B(WF),B(SF)/SE85:B)
R335	1-216-073-00	METAL CHIP	10K 5% 1/10W	C987	1-107-823-11	CERAMIC CHIP 0.47uF 10% 16V	(SF99:B/SF90:B(WF),B(SF)/SE85:B)
R336	1-216-164-00	RES,CHIP	39 5% 1/8W	C988	1-163-251-11	CERAMIC CHIP 100PF 5% 50V	(SF99:B/SF90:B(WF),B(SF)/SE85:B)
R337	1-216-164-00	RES,CHIP	39 5% 1/8W	C991	1-164-004-11	CERAMIC CHIP 0.1uF 10% 25V	(SF99:B/SF90:B(WF),B(SF)/SE85:B)
R344	1-216-063-91	RES,CHIP	3.9K 5% 1/10W				
R345	1-216-057-00	METAL CHIP	2.2K 5% 1/10W				

Ref. No.	Part No.	Description	Remarks	Ref. No.	Part No.	Description	Remarks
C992	1-163-021-91	CERAMIC CHIP 0.01uF 10% 50V (SF99:B/SF90:B(WF),B(SF)/SE85:B)				< RESISTOR >	
C993	1-163-021-91	CERAMIC CHIP 0.01uF 10% 50V (SF99:B/SF90:B(WF),B(SF)/SE85:B)		R968	1-216-101-00	METAL CHIP 150K 5% 1/10W (SF99:B/SF90:B(WF),B(SF)/SE85:B)	
C994	1-163-021-91	CERAMIC CHIP 0.01uF 10% 50V (SF99:B/SF90:B(WF),B(SF)/SE85:B)		R969	1-216-069-00	METAL CHIP 6.8K 5% 1/10W (SF99:B/SF90:B(WF),B(SF)/SE85:B)	
C995	1-126-157-11	ELECT 10uF 20% 16V (SF99:B/SF90:B(WF),B(SF)/SE85:B)		R970	1-216-085-00	METAL CHIP 33K 5% 1/10W (SF99:B/SF90:B(WF),B(SF)/SE85:B)	
C996	1-163-227-11	CERAMIC CHIP 10PF 0.5PF 50V (SF99:B/SF90:B(WF),B(SF)/SE85:B)		R971	1-216-085-00	METAL CHIP 33K 5% 1/10W (SF99:B/SF90:B(WF),B(SF)/SE85:B)	
		< CONNECTOR >		R972	1-216-083-00	METAL CHIP 27K 5% 1/10W (SF99:B/SF90:B(WF),B(SF)/SE85:B)	
CN970	1-573-825-11	CONNECTOR, BOARD TO BOARD 11P (SF99:B/SF90:B(WF),B(SF)/SE85:B)		R973	1-216-105-91	RES,CHIP 220K 5% 1/10W (SF99:B/SF90:B(WF),B(SF)/SE85:B)	
		< IC >		R974	1-216-081-00	METAL CHIP 22K 5% 1/10W (SF99:B/SF90:B(WF),B(SF)/SE85:B)	
IC970	8-759-438-17	IC LA7337 (SF99:B/SF90:B(WF),B(SF)/SE85:B)		R975	1-216-295-91	SHORT 0 (SF99:B/SF90:B(WF),B(SF))	
		< JUMPER RESISTOR >		R976	1-216-059-00	METAL CHIP 2.7K 5% 1/10W (SF99:B/SF90:B(WF),B(SF)/SE85:B)	
JR970	1-216-295-91	SHORT 0 (SF99:B/SF90:B(WF),B(SF)/SE85:B)		R977	1-216-089-91	RES,CHIP 47K 5% 1/10W (SF99:B/SF90:B(WF),B(SF))	
JR971	1-216-296-91	SHORT 0 (SF99:B/SF90:B(WF),B(SF)/SE85:B)		R978	1-216-071-00	METAL CHIP 8.2K 5% 1/10W (SF99:B/SF90:B(WF),B(SF)/SE85:B)	
JR972	1-216-296-91	SHORT 0 (SF99:B/SF90:B(WF),B(SF)/SE85:B)		R979	1-216-073-00	METAL CHIP 10K 5% 1/10W (SF99:B/SF90:B(WF),B(SF)/SE85:B)	
JR973	1-216-295-91	SHORT 0 (SF99:B/SF90:B(WF),B(SF)/SE85:B)		R980	1-216-097-91	RES,CHIP 100K 5% 1/10W (SF99:B/SF90:B(WF),B(SF)/SE85:B)	
JR974	1-216-295-91	SHORT 0 (SF99:B/SF90:B(WF),B(SF)/SE85:B)		R981	1-216-083-00	METAL CHIP 27K 5% 1/10W (SF99:B/SF90:B(WF),B(SF)/SE85:B)	
		< COIL >		R982	1-216-089-91	RES,CHIP 47K 5% 1/10W (SF99:B/SF90:B(WF),B(SF)/SE85:B)	
L970	1-414-933-21	INDUCTOR 6.8uH (SF99:B/SF90:B(WF),B(SF)/SE85:B)		R983	1-216-067-00	METAL CHIP 5.6K 5% 1/10W (SF99:B/SF90:B(WF),B(SF)/SE85:B)	
L971	1-414-945-21	INDUCTOR 27uH (SF99:B/SF90:B(WF),B(SF)/SE85:B)		R985	1-216-041-00	METAL CHIP 470 5% 1/10W (SF99:B/SF90:B(WF),B(SF)/SE85:B)	
L972	1-414-938-21	INDUCTOR 47uH (SF99:B/SF90:B(WF),B(SF)/SE85:B)		R986	1-216-089-91	RES,CHIP 47K 5% 1/10W (SF99:B/SF90:B(WF),B(SF)/SE85:B)	
L973	1-414-938-21	INDUCTOR 47uH (SF99:B/SF90:B(WF),B(SF)/SE85:B)		R988	1-216-077-91	RES,CHIP 15K 5% 1/10W (SF99:B/SF90:B(WF),B(SF)/SE85:B)	
L975	1-414-934-21	INDUCTOR 10uH (SF99:B/SF90:B(WF),B(SF)/SE85:B)		R989	1-216-049-91	RES,CHIP 1K 5% 1/10W (SF99:B/SF90:B(WF),B(SF)/SE85:B)	
		< TRANSISTOR >		R990	1-216-295-91	SHORT 0 (SF99:B/SF90:B(WF),B(SF))	
Q970	8-729-216-22	TRANSISTOR 2PB709AR-115 (SF99:B/SF90:B(WF),B(SF)/SE85:B)		R993	1-216-071-00	METAL CHIP 8.2K 5% 1/10W (SF99:B/SF90:B(WF),B(SF)/SE85:B)	
Q972	8-729-043-32	TRANSISTOR PDTA114EK-115 (SF99:B/SF90:B(WF),B(SF)/SE85:B)		R994	1-216-689-11	METAL CHIP 39K 0.5% 1/10W (SF99:B/SF90:B(WF),B(SF)/SE85:B)	
Q973	8-729-422-33	TRANSISTOR 2PD601AR-115 (SF99:B/SF90:B(WF),B(SF)/SE85:B)		R995	1-216-073-00	METAL CHIP 10K 5% 1/10W (SF99:B/SF90:B(WF),B(SF)/SE85:B)	
Q974	8-729-422-33	TRANSISTOR 2PD601AR-115 (SF99:B/SF90:B(WF),B(SF)/SE85:B)		R996	1-216-689-11	METAL CHIP 39K 0.5% 1/10W (SF99:B/SF90:B(WF),B(SF)/SE85:B)	
Q975	8-729-043-32	TRANSISTOR PDTA114EK-115 (SF99:B/SF90:B(WF),B(SF)/SE85:B)		R997	1-216-073-00	METAL CHIP 10K 5% 1/10W (SF99:B/SF90:B(WF),B(SF)/SE85:B)	
Q976	8-729-043-29	TRANSISTOR PDTC144EK-115 (SF99:B/SF90:B(WF),B(SF)/SE85:B)		R998	1-216-073-00	METAL CHIP 10K 5% 1/10W (SF99:B/SF90:B(WF),B(SF)/SE85:B)	
				R999	1-216-295-91	SHORT 0 (SF99:B/SF90:B(WF),B(SF)/SE85:B)	

POWER BLOCK

Ref. No.	Part No.	Description	Remarks	Ref. No.	Part No.	Description	Remarks
△	1-468-398-11	POWER BLOCK (SRV879EK) ***** (Ref.No:4000 Series)				< IC >	
		< CAPACITOR >		△ IC151	9-980-235-01	IC AN8028	
△ C151	9-980-236-01	ELECT	47uF	400V	IC201	8-759-438-18	IC PQ12RD08
C153	1-126-967-11	ELECT	47uF	50V	IC251	8-759-420-19	IC AN1431T
C154	1-126-960-11	ELECT	1uF	50V		< IC LINK >	
C201	1-126-934-11	ELECT	220uF	16V	△ PS201	1-533-592-21	LINK, IC 1.6A
C202	1-126-925-11	ELECT	470uF	10V	△ PS202	1-533-593-21	LINK, IC 2A
					△ PS251	1-533-588-21	LINK, IC 750mA
C203	1-126-947-11	ELECT	47uF	35V		< PHOTOCOUPLER >	
C204	1-126-933-11	ELECT	100uF	16V	△ PC151	9-903-923-01	PHOTOCOUPLER ON3171
C205	1-126-965-11	ELECT	22uF	50V		< TRANSISTOR >	
C206	1-126-947-11	ELECT	47uF	35V	Q151	9-880-931-01	FET FS2KM-16
C207	1-126-934-11	ELECT	220uF	16V	Q201	8-729-040-88	TRANSISTOR 2SB1240
C208	1-126-925-11	ELECT	470uF	10V	Q204	9-880-929-01	TRANSISTOR 2SC1740
C251	1-126-967-11	ELECT	47uF	50V	Q205	8-729-018-99	TRANSISTOR 2SD2394
C252	1-124-534-11	ELECT	680uF	16V	Q206	8-729-119-79	TRANSISTOR 2SC2785
C253	1-124-567-11	ELECT	1200uF	10V	Q207	8-729-049-82	TRANSISTOR 2SD1863
C254	1-126-967-11	ELECT	47uF	50V	Q208	8-729-040-21	TRANSISTOR 2SD1862
C255	1-126-925-11	ELECT	470uF	10V	Q209	9-880-930-01	TRANSISTOR UN4111
C301	1-126-969-11	ELECT	220uF	50V	Q210	9-880-930-01	TRANSISTOR UN4111
C302	1-126-969-11	ELECT	22uF	50V	Q211	8-729-422-72	TRANSISTOR UN4211
C303	1-126-965-11	ELECT	22uF	50V	Q301	8-729-018-99	TRANSISTOR 2SD2394
		< DIODE >		Q302	9-880-929-01	TRANSISTOR 2SD1740	
D101	9-880-927-01	DIODE IN4005		Q303	8-729-018-99	TRANSISTOR 2SD2394	
D102	9-880-927-01	DIODE IN4005		Q304	8-729-119-79	TRANSISTOR 2SC2785	
D103	9-880-927-01	DIODE IN4005		Q305	8-729-040-88	TRANSISTOR 2SB1240	
D104	9-880-927-01	DIODE IN4005		Q306	9-880-929-01	TRANSISTOR 2SD1740	
D151	8-719-077-06	DIODE RB721Q-40		Q307	8-729-231-11	TRANSISTOR 2SA1015	
D152	9-880-932-01	DIODE EG01C			< RESISTOR >		
D153	8-719-911-19	DIODE ISS119		R251	9-880-993-01	CARBON 10 1/4W	
D154	8-719-077-06	DIODE RB721Q-40			< VARISTOR >		
D155	8-719-061-02	DIODE PR1003		△ Z101	9-880-928-01	VARISTOR ERZV10D751	
D156	9-880-990-01	DIODE IN4005			MISCELLANEOUS		
D158	9-880-991-01	DIODE MA4270			*****		
D159	8-719-922-10	DIODE MTZJ22		16	1-762-844-31	SWITCH, ROTARY	
D203	8-719-921-42	DIODE MTZJ5.1		26	1-418-389-11	SWITCH BLOCK, CONTROL (SF90:UX(SF),VC(SF),NP(SF),EX)	
D204	8-719-911-19	DIODE ISS119		26	1-418-389-21	SWITCH BLOCK, CONTROL (SF90:B(SF))	
D205	8-719-911-19	DIODE ISS119		26	1-418-389-31	SWITCH BLOCK, CONTROL (SF99:UX,EN,NP,VC)	
D251	8-719-061-02	DIODE PR1003		26	1-418-389-41	SWITCH BLOCK, CONTROL (SF99:B)	
D252	8-719-510-73	DIODE S3L20U		26	1-418-389-51	SWITCH BLOCK, CONTROL (SF90:UX(WF),VC(WF),NP(WF))	
D253	8-719-027-20	DIODE D3S4M		26	1-418-389-61	SWITCH BLOCK, CONTROL (SF90:B(WF))	
D254	8-719-061-02	DIODE PR1003		52	1-779-725-11	CONNECTOR, BOARD TO BOARD 5P	
D255	8-719-061-02	DIODE PR1003		△ 57	1-782-012-11	CORD, POWER (SE85)	
D301	8-719-510-73	DIODE S3L20U		△ 57	1-783-931-11	CORD, POWER (SF99/SF90)	
D302	8-719-018-83	DIODE D2S4M					
D303	8-719-034-92	DIODE MA4180					
D304	8-719-018-83	DIODE D2S4M					
D305	8-719-911-19	DIODE ISS119					
D306	8-719-911-19	DIODE ISS119					
D307	8-719-018-83	DIODE D2S4M					
		< FUSE >					
△ F101	1-532-388-31	FUSE, TIME LUG T2A/250V					

Note : The components identified by mark △ or dotted line with mark △ are critical for safety. Replace only with part number specified.	Note : Les composants identifiés par une marque △ sont critiques pour la sécurité. Ne les remplacer que par une pièce portant le numéro spécifié.
---	---

Ref. No.	Part No.	Description	Remarks
△ 60	1-468-398-11	POWER BLOCK	
704	1-500-144-11	HEAD, FE	
768	1-759-373-22	DRUM ASSY (DZH-86A-R)	
		(SE85:NP,VC,UX/SF90:NP,VC,UX,EX/SF99:EN,NP,UX,VC)	
768	1-759-557-22	DRUM ASSY (DZH-98A-R)	
		(SE85:B/SF90:B/SF99:B)	
831	1-766-723-21	CONNECTOR, BOARD TO BOARD 3P	
834	1-666-524-11	PWB, CA-55	
838	1-541-309-11	MOTOR, L (RF-370C)	
M902	1-698-971-11	MOTOR, DC (CAPSTAN)	
M903	X-3947-577-1	MOTOR ASSY, CAM	

ACCESSORIES

1-696-593-11	CORD, CONNECTION (PAL)	(SF99/SF90:UX(WF),B(WF),VC(WF),UX(SF),B(SF),VC(SF),EX/SE85)
1-696-861-11	CORD, CONNECTION (SF90:NP(WF),NP(SF))	
1-696-593-11	CORD, CONNECTION (PAL)	(SF99/SF90:UX(WF),B(WF),VC(WF),UX(SF),B(SF),VC(SF),EX/SE85)
1-696-861-11	CORD, CONNECTION (SF90:NP(WF),NP(SF))	
3-867-077-11	INSTRUCTION MANUAL	(SF90:VC(WF),NP(WF),VC(SF),NP(SF)/SE85:VC)
3-867-077-21	INSTRUCTION MANUAL	(SF90:B(WF),VC(WF),NP(WF),B(SF),VC(SF),NP(SF)/SE85:B,VC)
3-867-077-31	INSTRUCTION MANUAL	(SF90:VC(WF),VC(SF)/SE85:VC)
3-867-077-41	INSTRUCTION MANUAL	(SF90:VC(WF),NP(WF),VC(SF),NP(SF))
3-867-082-11	INSTRUCTION MANUAL	(SF90:NP(WF),NP(SF)/SE85:NP)
3-867-082-21	INSTRUCTION MANUAL	(SF90:NP(WF),NP(SF)/SE85:NP)
3-867-082-31	INSTRUCTION MANUAL (SF90:NP(WF),NP(SF))	
3-867-082-41	INSTRUCTION MANUAL (SF90:NP(WF),NP(SF))	
3-867-082-51	INSTRUCTION MANUAL (SF90:NP(WF),NP(SF))	
3-867-087-11	INSTRUCTION MANUAL	(SF90:UX(WF),UX(SF),EX/SE85:UX)
3-867-587-11	MANUAL, INSTRUCTION (SF99:UX)	
3-867-590-11	MANUAL, INSTRUCTION (SF99:NP,VC)	
3-867-590-21	MANUAL, INSTRUCTION (SF99:NP,VC)	
3-867-590-31	MANUAL, INSTRUCTION (SF99:VC)	
3-867-590-41	MANUAL, INSTRUCTION (SF99:NP,VC)	
3-867-592-11	MANUAL, INSTRUCTION (SF99:B)	
3-867-594-11	MANUAL, INSTRUCTION (SF99:NP)	
3-867-594-21	MANUAL, INSTRUCTION (SF99:NP)	
3-867-594-31	MANUAL, INSTRUCTION (SF99:NP)	
3-867-594-41	MANUAL, INSTRUCTION (SF99:NP)	
3-867-594-51	MANUAL, INSTRUCTION (SF99:NP)	
3-867-596-11	MANUAL, INSTRUCTION (SF99:EN)	
3-867-596-21	MANUAL, INSTRUCTION (SF99:EN)	
3-867-596-31	MANUAL, INSTRUCTION (SF99:EN)	
3-867-596-41	MANUAL, INSTRUCTION (SF99:EN)	
3-867-596-51	MANUAL, INSTRUCTION (SF99:EN)	
3-867-596-61	MANUAL, INSTRUCTION (SF99:EN)	

Ref. No.	Part No.	Description	Remarks

		HARDWARE LIST	

#1	7-685-648-79	SCREW +BVTP 3X12 TYPE2	
#701	7-685-646-79	SCREW +BVTP 3X8 TYPE2	
#702	7-682-147-01	SCREW +P 3X6	
#703	7-685-133-19	SCREW (DIA. 2.6) (IT3B)	

Note :

The components identified by mark △ or dotted line with mark △ are critical for safety. Replace only with part number specified.

Note :

Les composants identifiés par une marque △ sont critiques pour la sécurité. Ne les remplacer que par une pièce portant le numéro spécifié.

